

# ASSEMBLY INSTRUCTION

N717P170412

x4

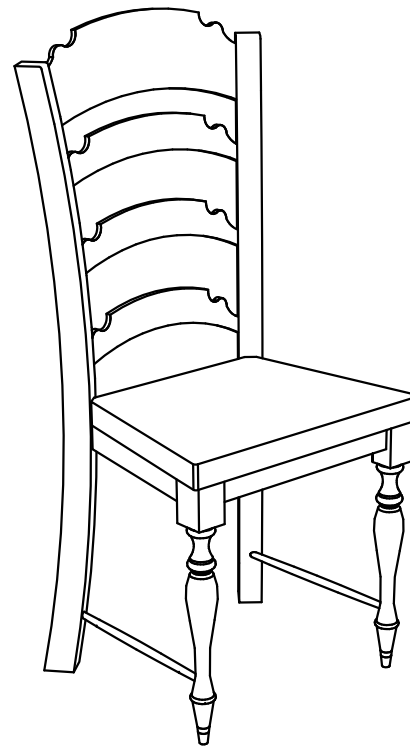

**PARTS LIST - N717P170412**  
**Part List for One**

A

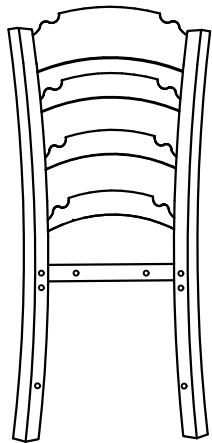

Quantity:  
1 pc

B

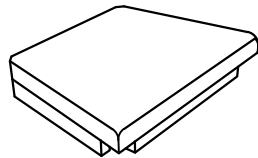

Quantity:  
1 pc

C<sub>L</sub>

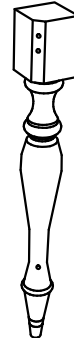

Quantity:  
1 pc

C<sub>R</sub>



Quantity:  
1 pc



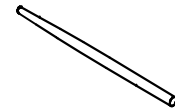



D

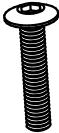
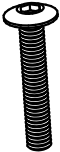

Quantity:  
2 pcs

# HARDWARE LIST - N717P170412

## Hardware List for One

①	②	③	④	⑤	⑥	⑦
						
Allen key Quantity: 1 pc	6x35mm Quantity: 2 pcs	6x50mm Quantity: 4 pcs	6x70mm Quantity: 4 pcs	6x16mm Quantity: 10 pcs	5x30mm Quantity: 4 pcs	Screwdrivers Quantity: 1 pc

# COMPONENTS - KEY DIAGRAM

N717P170412

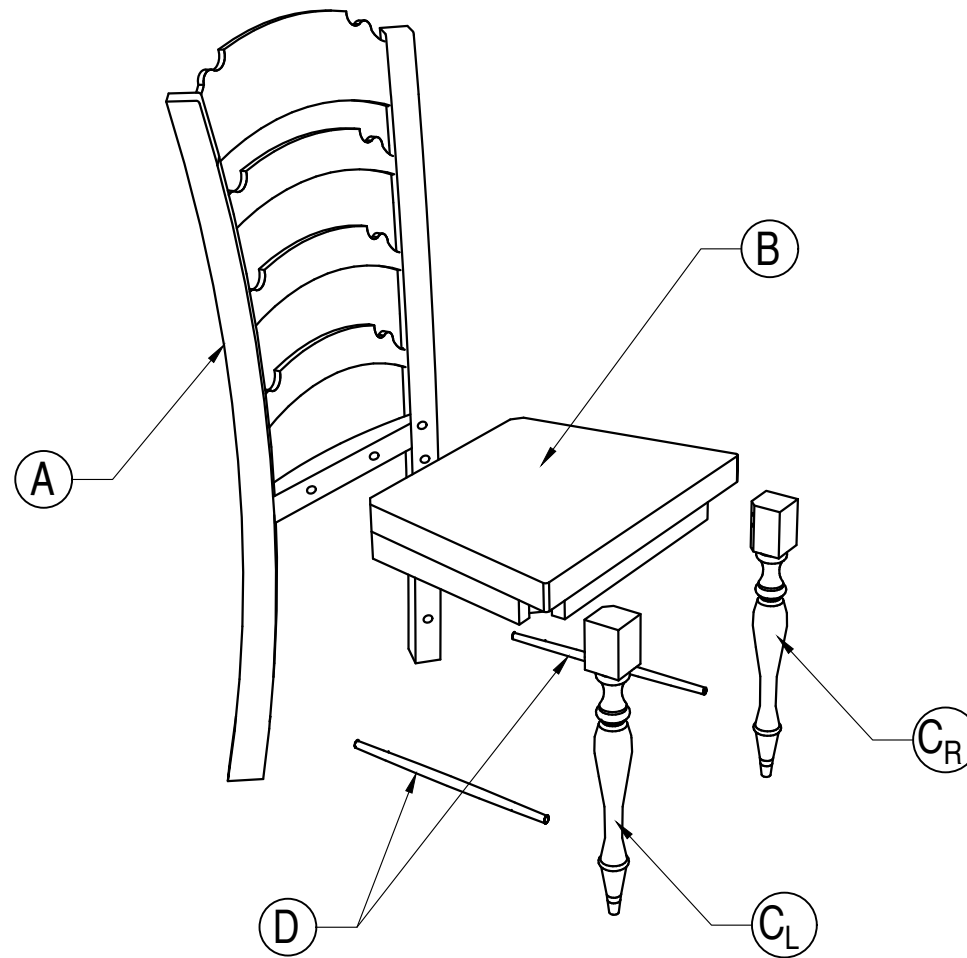

x4

# STEP 1

1



1 pc

2



6x35mm  
2 pcs

4



6x70mm  
4 pcs

5



6x16mm  
6 pcs

6



5x30mm  
2 pcs

7



1 pc

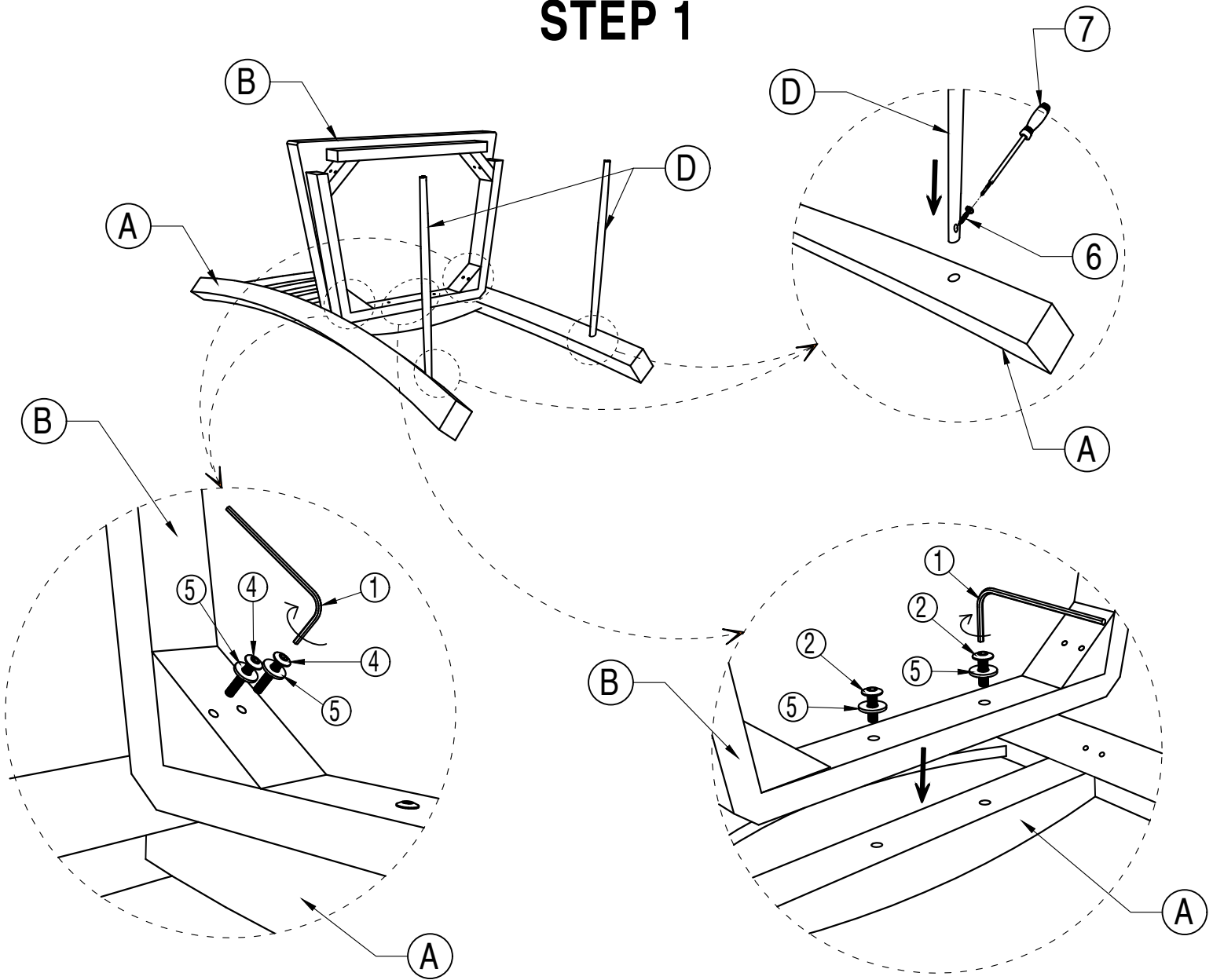

# STEP 2

1



1 pc

3

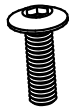

6x50mm  
4 pcs

5



6x16mm  
4 pcs

6



5x30mm  
2 pcs

7



1 pc

