

# Kitchen Island Set

WF296472+WF296518

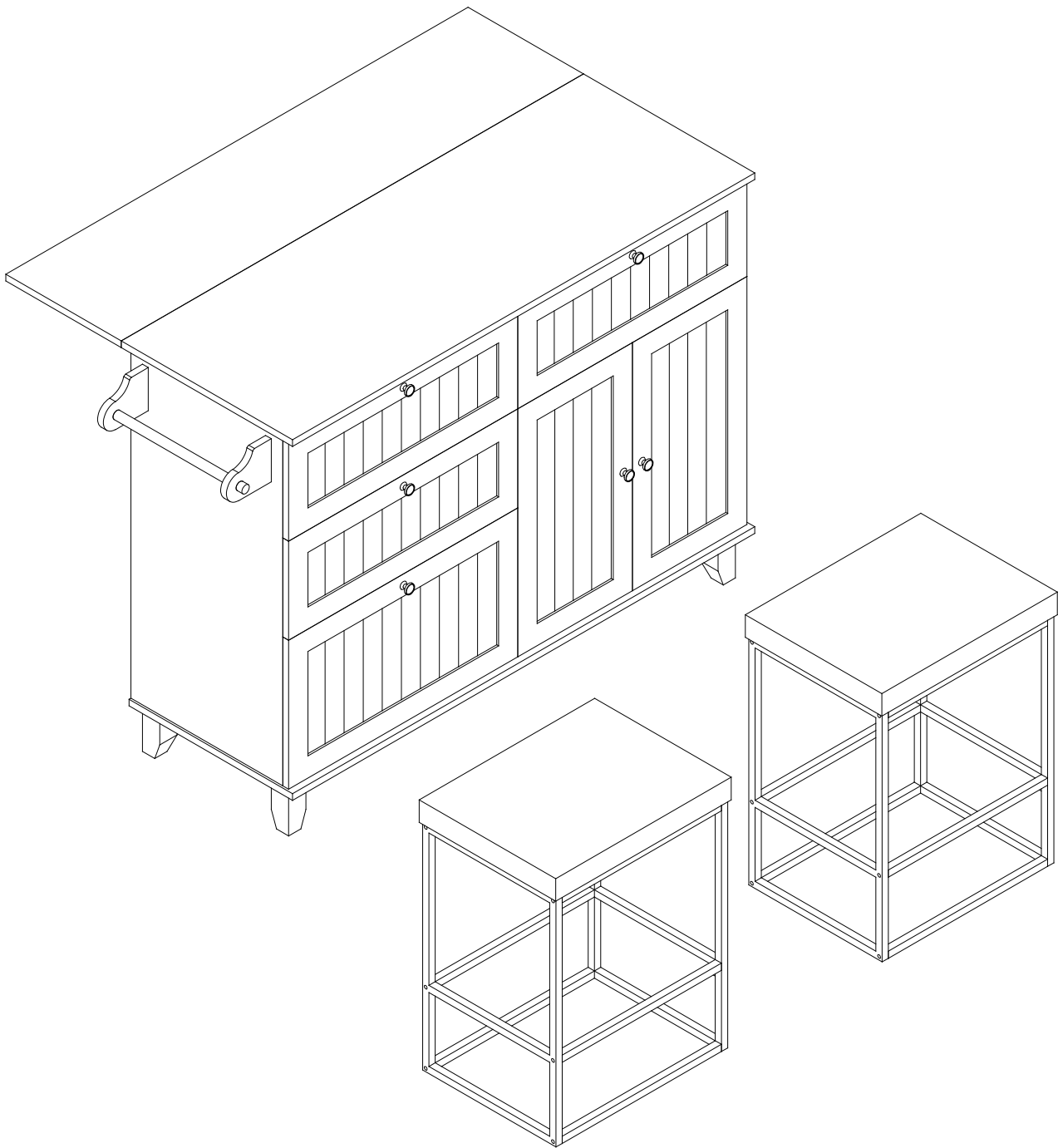



# Safety and Care Advice

**Important – Please read these instructions fully before starting assembly**

- Check you have all the components and tools listed on the following pages.
- Remove all fittings from the plastic bags and separate them into their groups.
- Keep children and animals away from the work area, small parts could choke if swallowed.
- Make sure you have enough space to layout the parts before starting.

- During assembly do not stand or put weight on the product, this could cause damage.
- Assemble the item as close to its final position (in the same room) as possible.
- Assemble on a soft level surface to avoid damaging the unit or your floor.
- Parts of the assembly will be easier with 2 people.



power drill is set on a low torque setting.

- To reduce the likelihood of damaging your product please ensure that your

## Care and maintenance

- Only clean using a damp cloth and mild detergent, do not use bleach or abrasive cleaners.
- From time to time check that there are no loose screws on this unit.
- This product should not be discarded with household waste. Take to your local authority waste disposal centre.

## Handy Hints











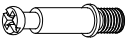

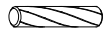

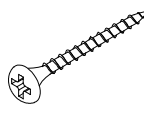

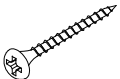

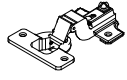
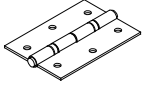

- Assemble all parts and bolts loosely during assembly, only once the product is complete should you fully tighten the bolts
- Regularly check and ensure That all bolts and fittings are tightend properly.

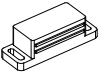
## **WARNING** In order to help prevent overturning – please follow these instructions

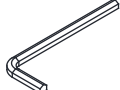
To help prevent product toppling over please follow the below steps:-

- Use the anti tip stap or wall fixing method provided (if applicable)
- Do not allow children to climb or hang on the furniture
- Do not open more than one drawer at a time
- Do not place heavy items in the top drawers
- Do not place heavy items on top of the furniture, unless the furniture has been designed for this purpose

# Components - Fittings

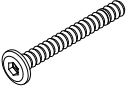
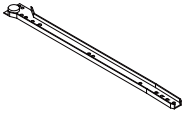
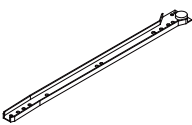
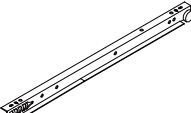
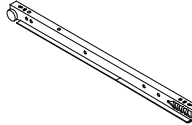
 <b>A x 46</b>	 <b>B x 46</b>	 <b>C x 41</b>	 <b>3.5x12</b> <b>D x 83</b>	 <b>5x45</b> <b>E x 4</b>	 <b>3x14</b> <b>F x 4</b>	 <b>4x35</b> <b>G x 20</b>
 <b>H x 6</b>	 <b>4x16</b> <b>I x 24</b>	 <b>J x 6</b>	 <b>K x 4</b>	 <b>L x 3</b>	 <b>M x 2</b>	 <b>N x 2</b>
 <b>O x 4</b>	 <b>Q x 1</b>	 <b>S x 9</b>	 <b>4x16</b> <b>T x 8</b>	 <b>6 x 40</b> <b>U x 14</b>	 <b>V x 4</b>	 <b>4x12</b> <b>W x 3</b>
 <b>6 x 40</b> <b>Y x 32</b>	 <b>CL x 4</b>	 <b>CR x 4</b>	 <b>DL x 4</b>	 <b>DR x 4</b>		

## Tools required

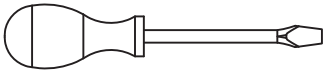

Phillips screwdriver  
(medium & large)

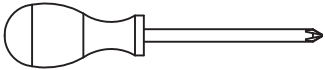

## Ruler - Use this ruler to help correctly identify the screws

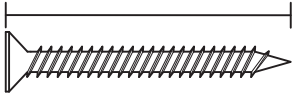
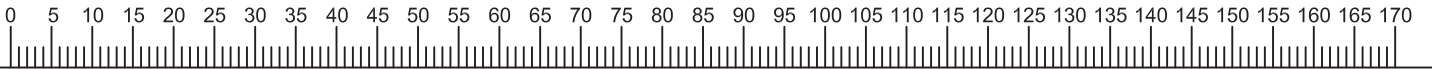

The screws length is measured from the head to the point (35mm screw shown).

# Using Camlocks

## Step 1

Connect the male camlock as directed in the assembly instructions using a screwdriver.

1

DO NOT OVER TIGHTEN.  
NE PAS SERRER EXCESSIVEMENT.

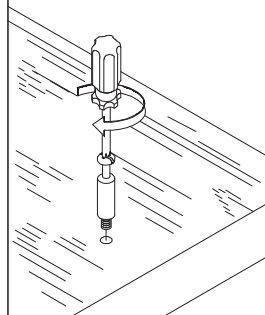

## Step 2

Push the male camlock into the entry hole.

2

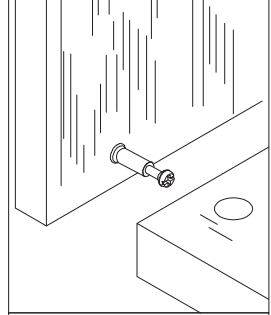

## Step 3

Insert the female camlock as shown in the instruction.

Note: ensure that the arrow on the top of the camlock points towards the entry hole for the male camlock.

3

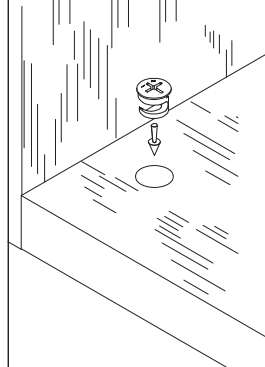

## Step 4

Turn the female camlock clockwise with a screwdriver.

You should feel a click when the camlock is locked in place.

The joint is now secure.

4

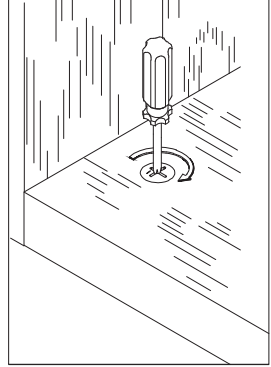

# Adjusting Hinges

## Hinge adjustment:

a: To move the top panel up or down, loosen screws shown and move top panel to suit

b. To move the top panel in or out, loosen screws shown and move top panel to suit.

Retighten screws

C: To move the top panel left or right, adjust screws shown.

a:

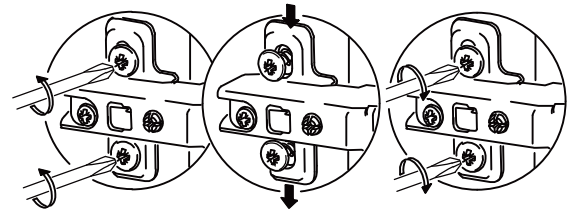
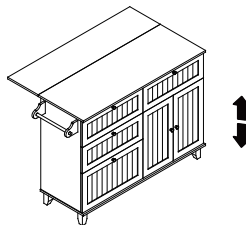

b:

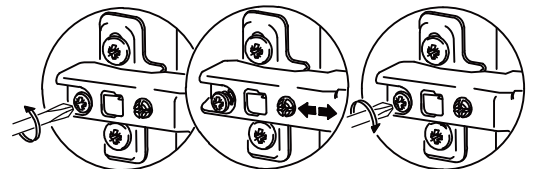
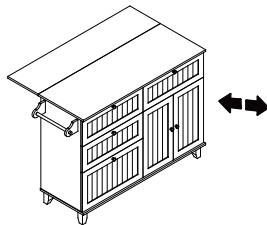

c:

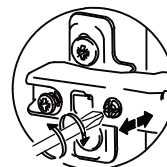
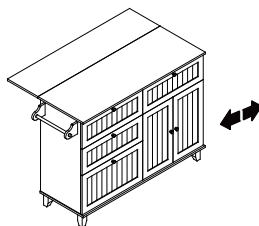

# Assembly Instructions

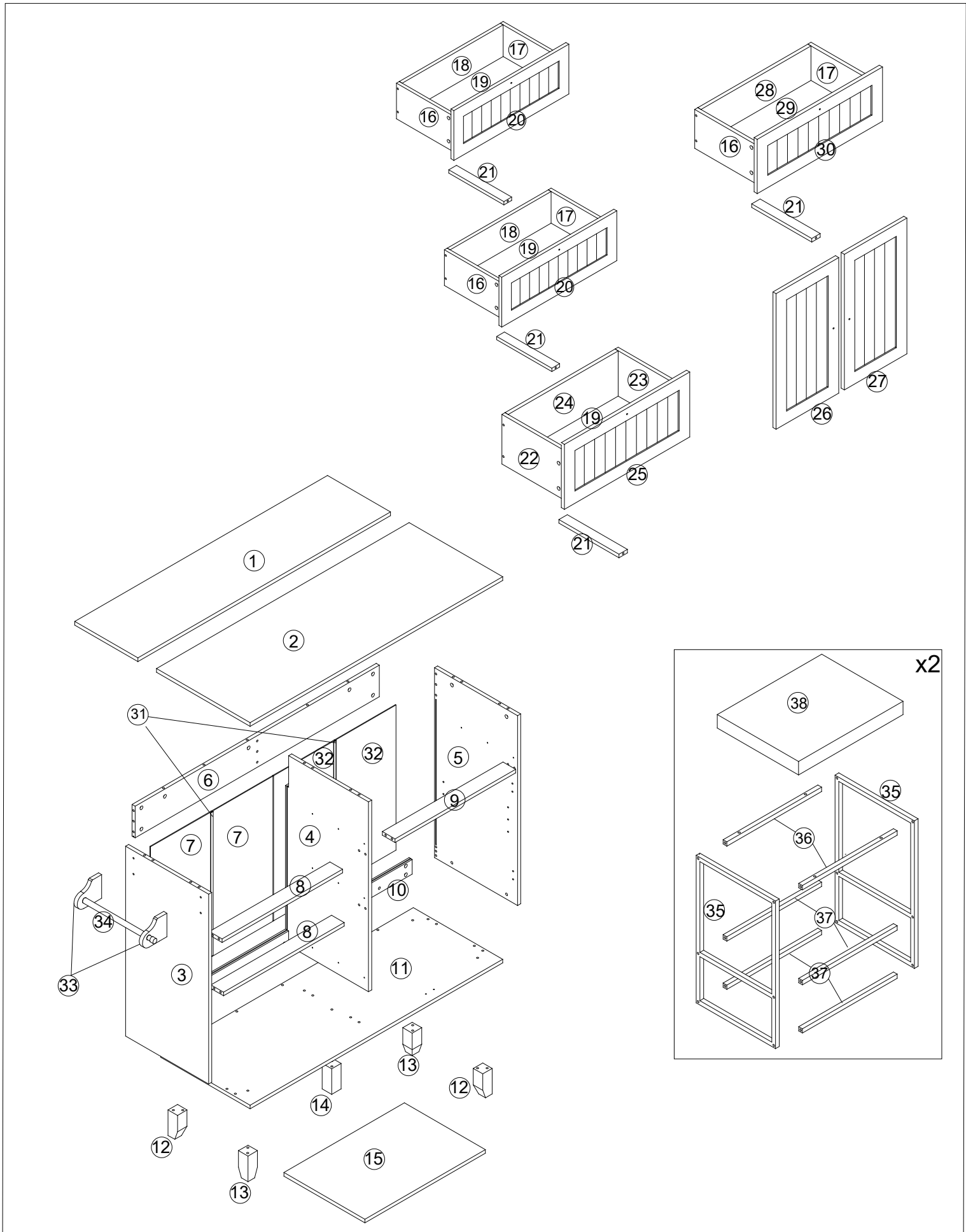

# WF296472 BOX-1

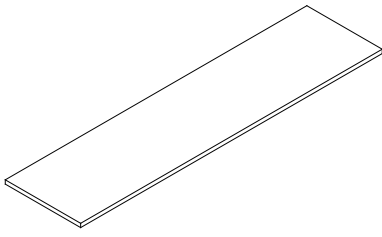

① x1

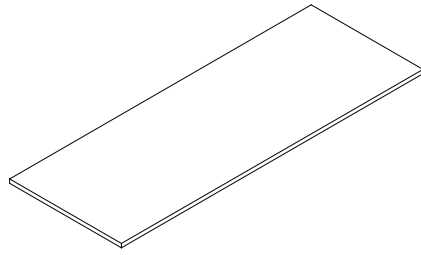

② x1

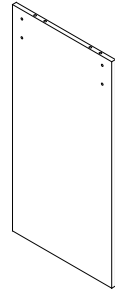

③ x1

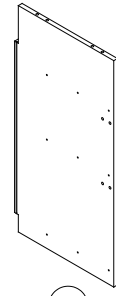

④ x1

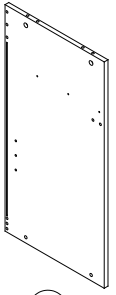

⑤ x1

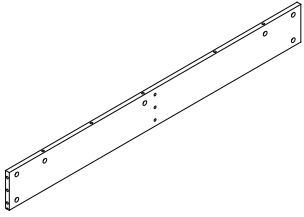

⑥ x1



⑦ x2

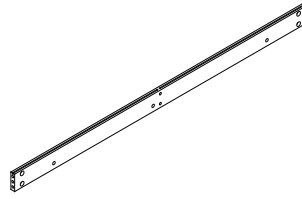

⑩ x1

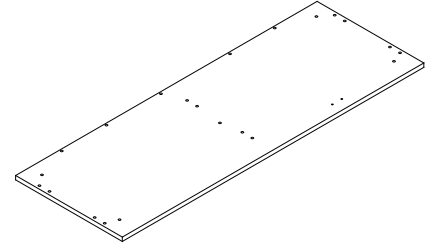

⑪ x1



⑫ x2



⑬ x2



⑭ x1



⑳ x2



㉓ x2



㉖ x2



㉘ x1

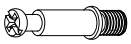

A x 46



B x 46

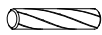

C x 41



3.5x12  
D x 83

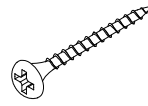

5x45  
E x 4



3x14  
F x 4

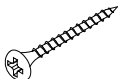

4x35  
G x 20



H x 6

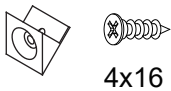

I x24



J x 6



K x 4

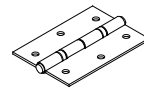

L x 3



M x 2

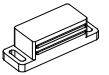

N x 2



O x 4

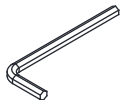

Q x 1



S x 9



4x16  
T x 8



6 x 40  
U x 14



V x 4

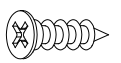

4x12  
W x 3



6 x 40  
Y x 32

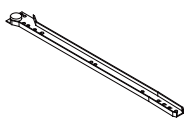

CL x 4

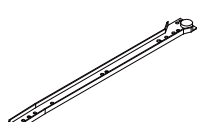

CR x 4

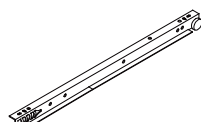

DL x 4

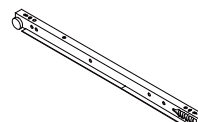

DR x 4

# WF296518 BOX-2

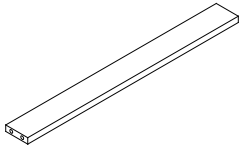

8 x2

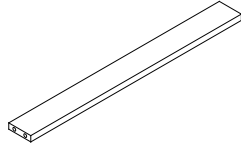

9 x1

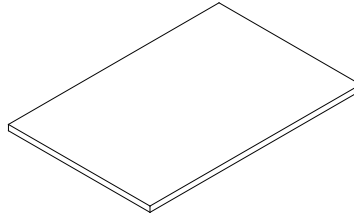

15 x1

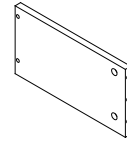

16 x3

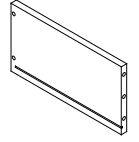

17 x3

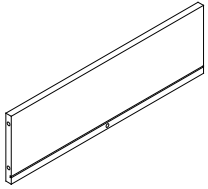

18 x2

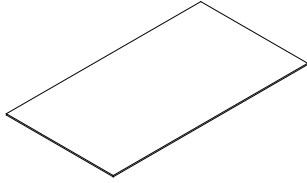

19 x3

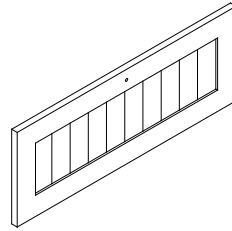

20 x2

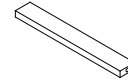

21 x4

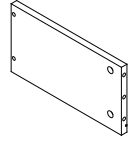

22 x1

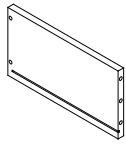

23 x1

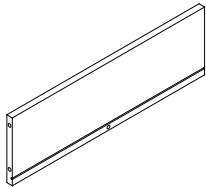

24 x1

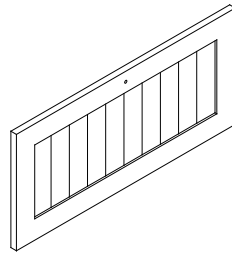

25 x1

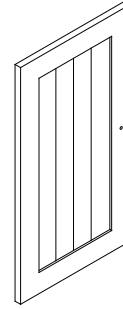

26 x1

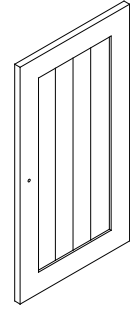

27 x1

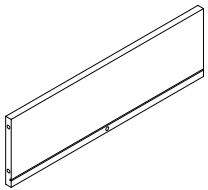

28 x1

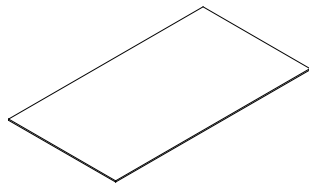

29 x1

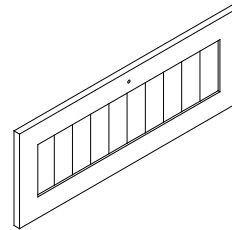

30 x1

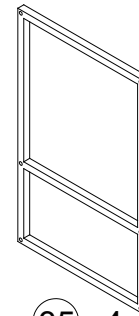

35 x4

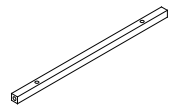

36 x4

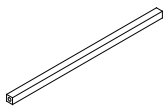

37 x8

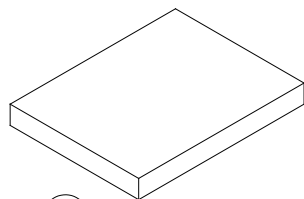

38 x2



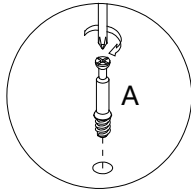
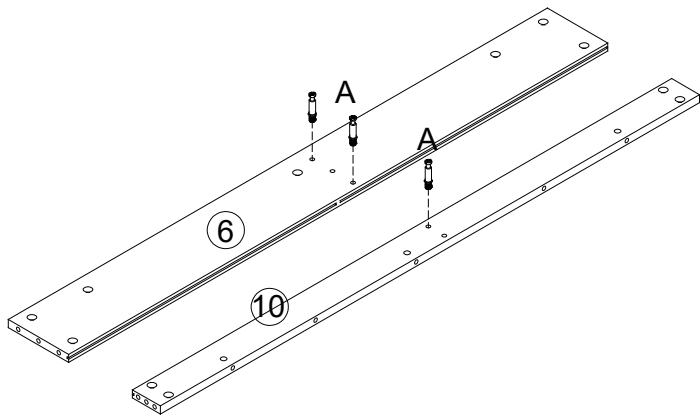

# STEP 1

A		3
---	---	---

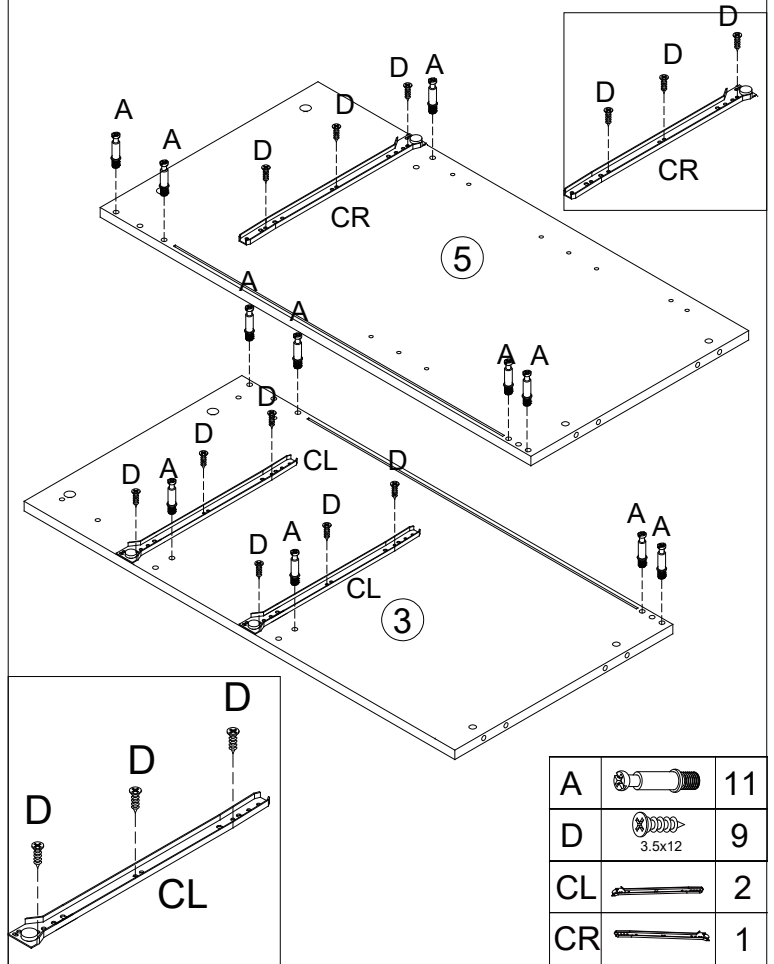





# STEP 2





A		11
D	 3.5x12	9
CL		2
CR		1

# STEP 3

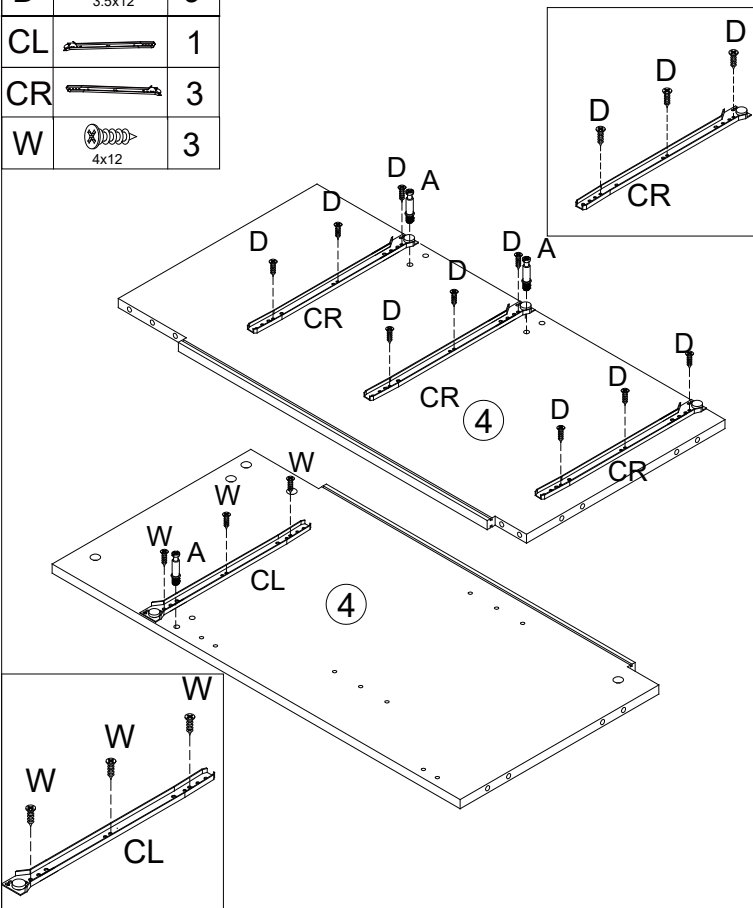
A		3
D	 3.5x12	9
CL		1
CR		3
W	 4x12	3



# STEP 4

B		3
C		2

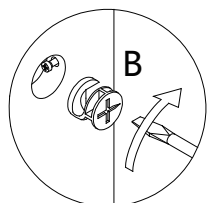
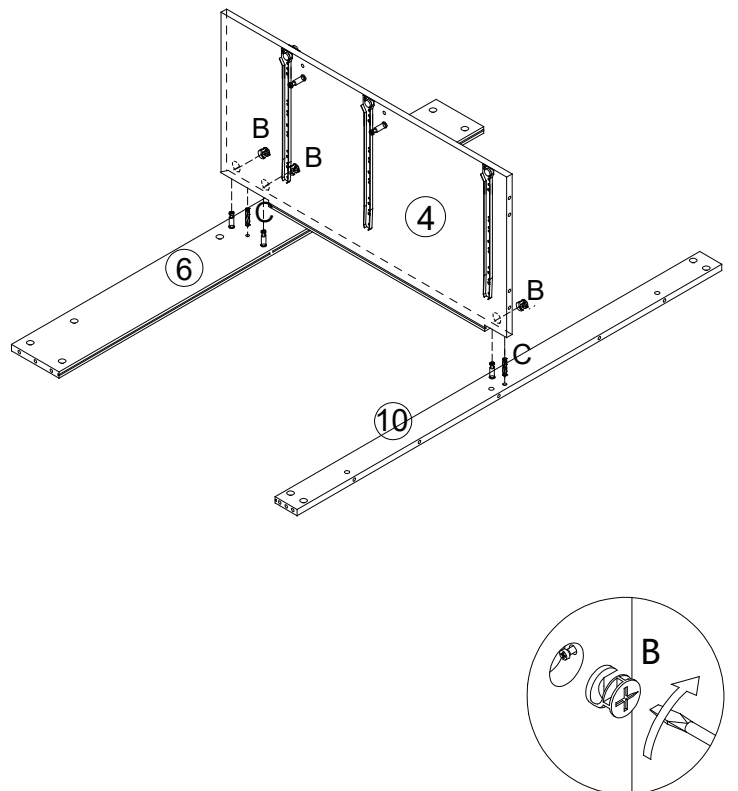



### STEP 5

B		6
C		4

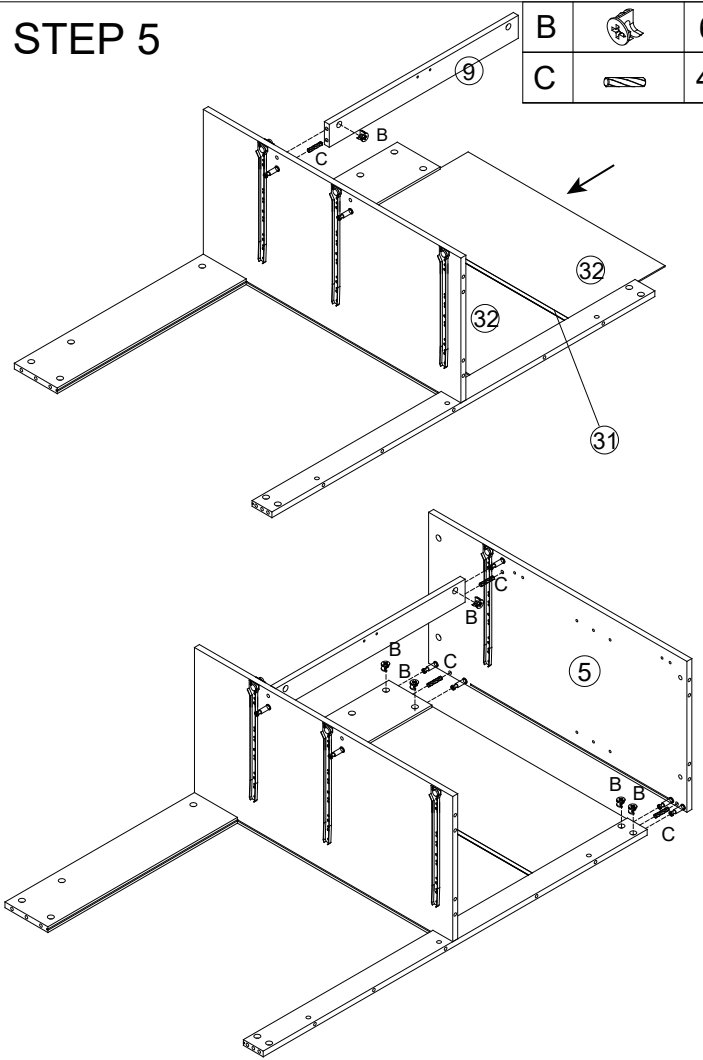

### STEP 6

B		8
C		6

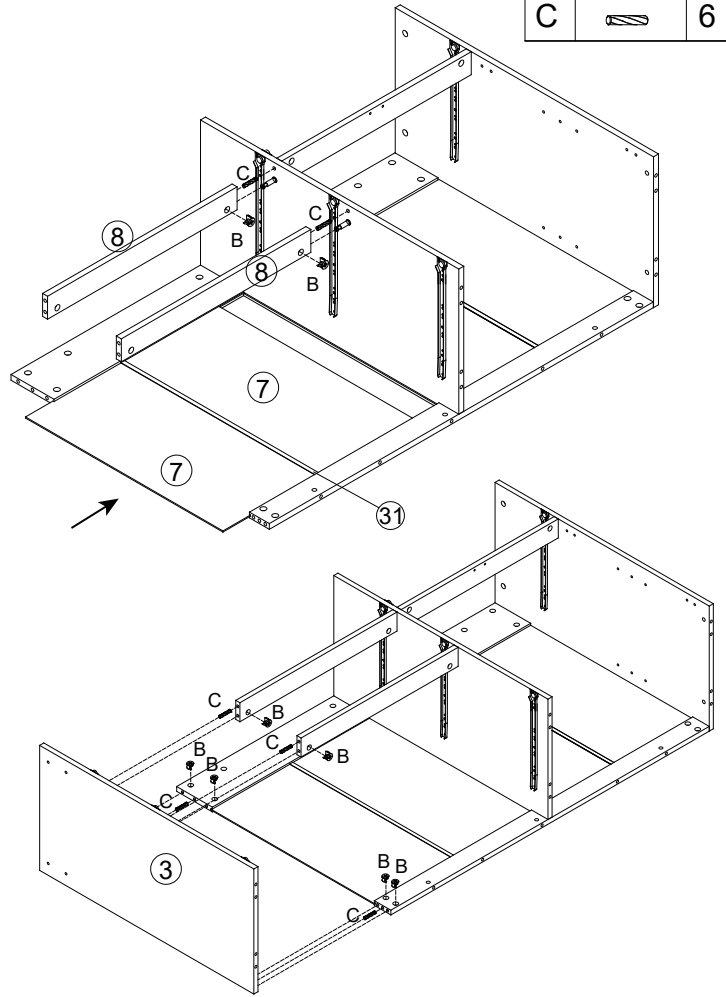

### STEP 7

F		2
C		5
N		1
U		5
Q		1

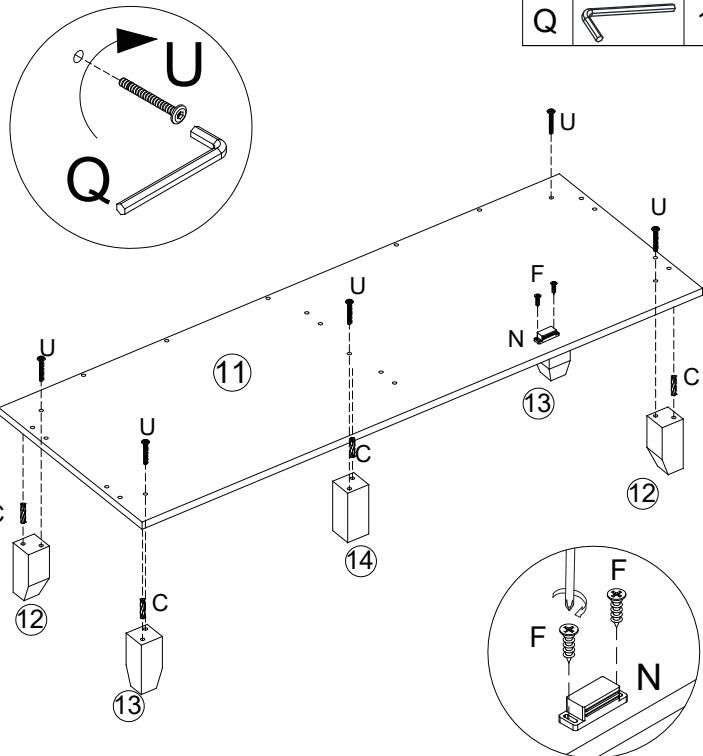

### STEP 8

F		2
C		8
N		1
U		9
S		9
Q		1

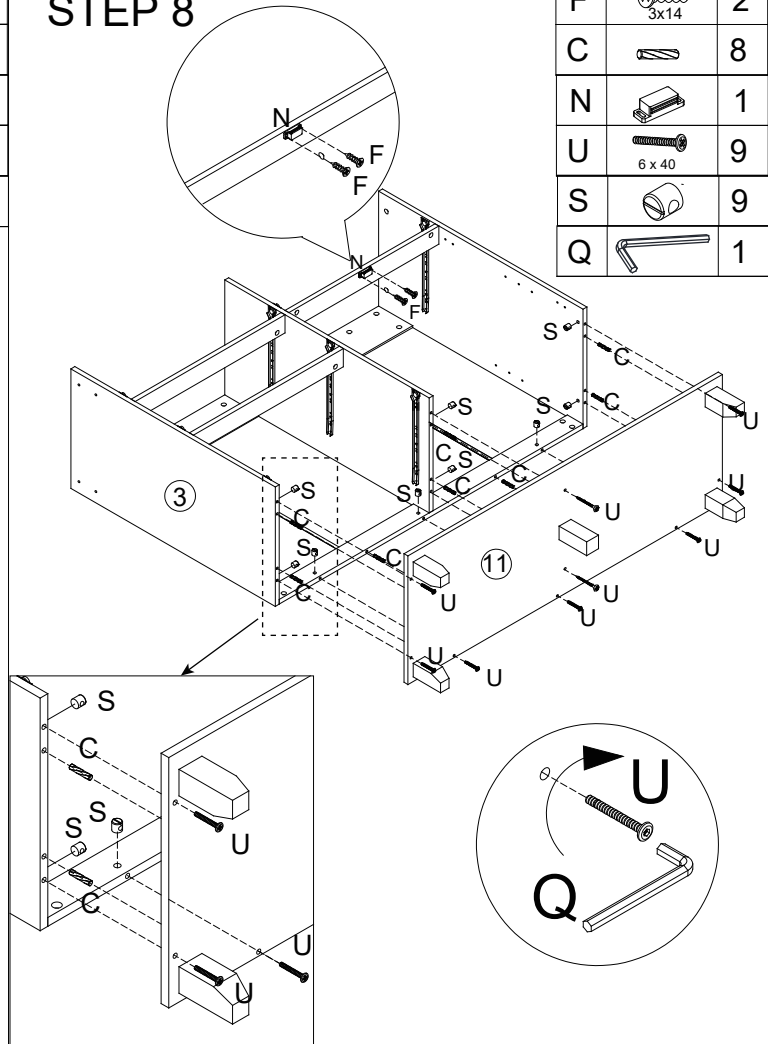

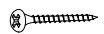

# STEP 9

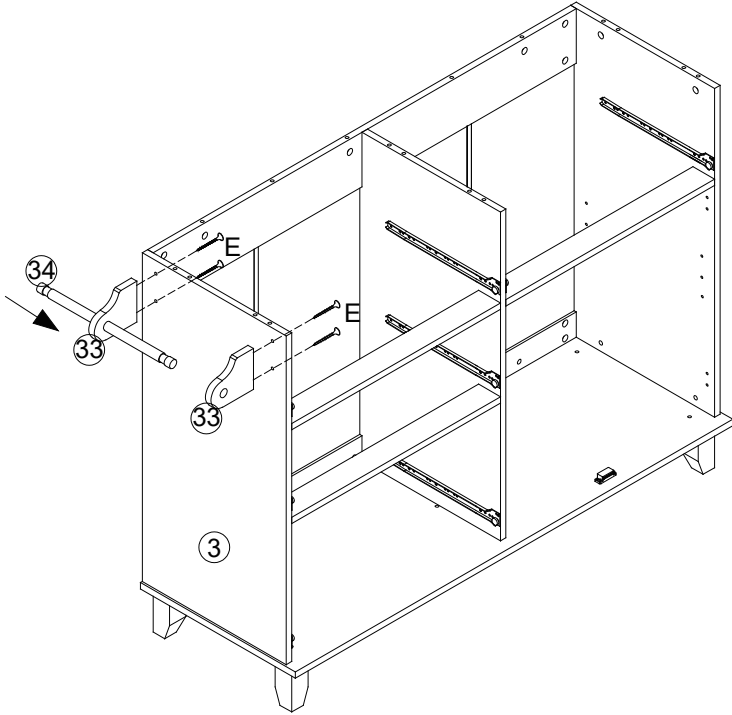
E		4
---	---	---





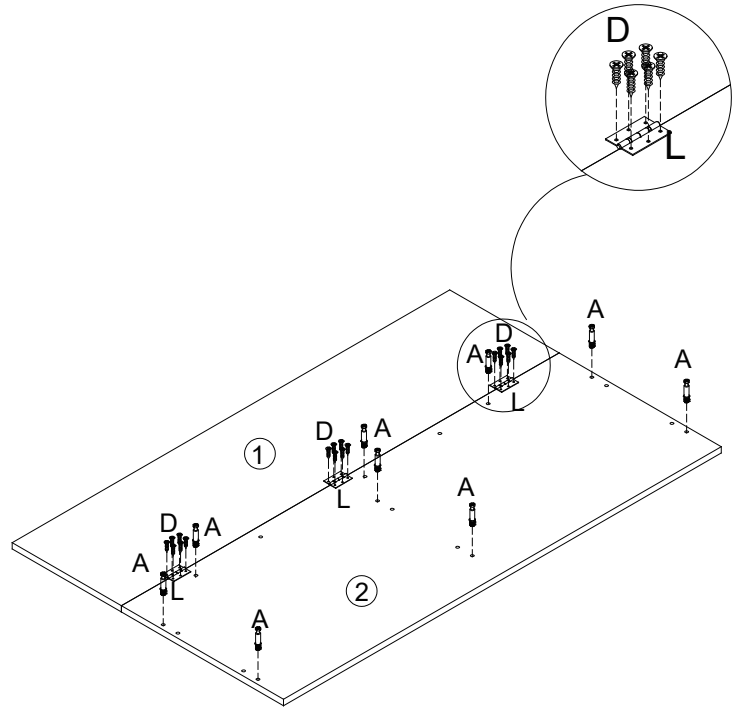

# STEP 10

A		9
D		18
L		3



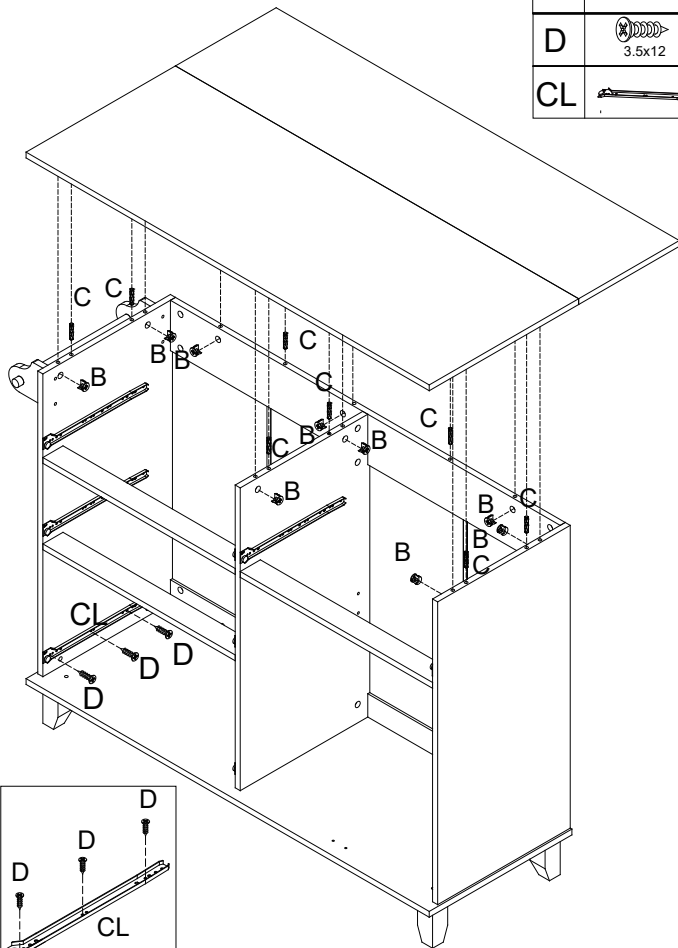

# STEP 11

B		9
C		8
D		3
CL		1





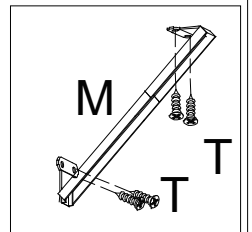
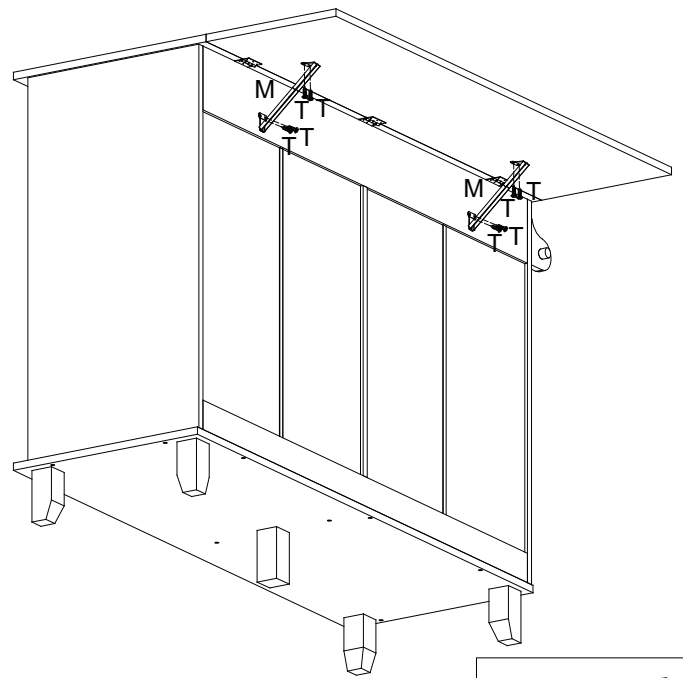

# STEP 12

M		2
T		8





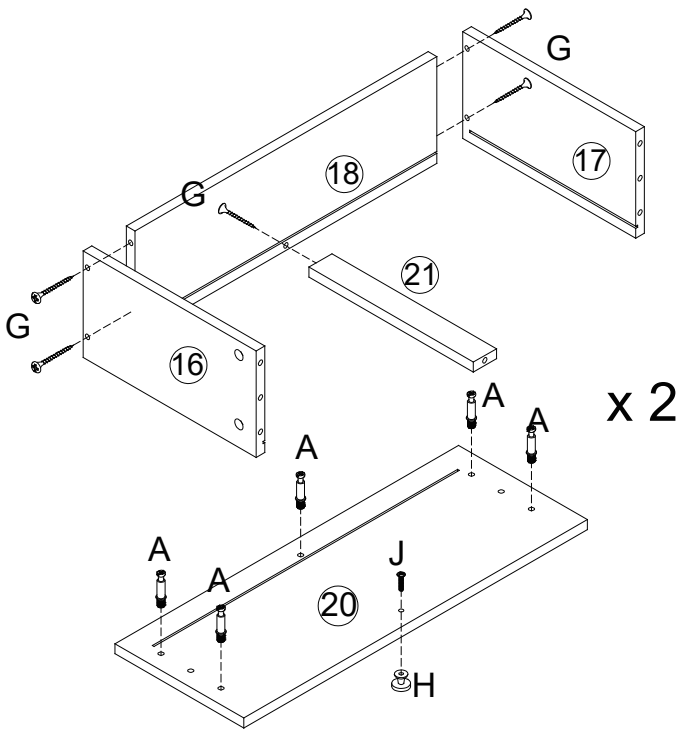

### STEP 13

A		10
G	 4x35	10
J		2
H		2





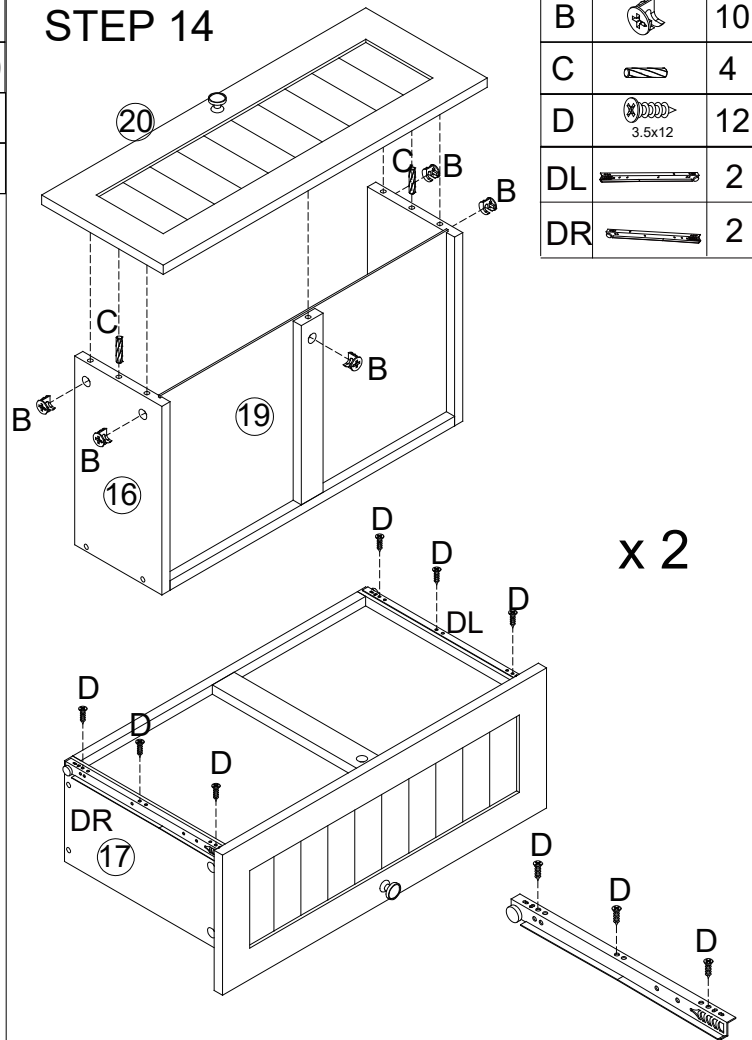

### STEP 14

B		10
C		4
D	 3.5x12	12
DL		2
DR		2





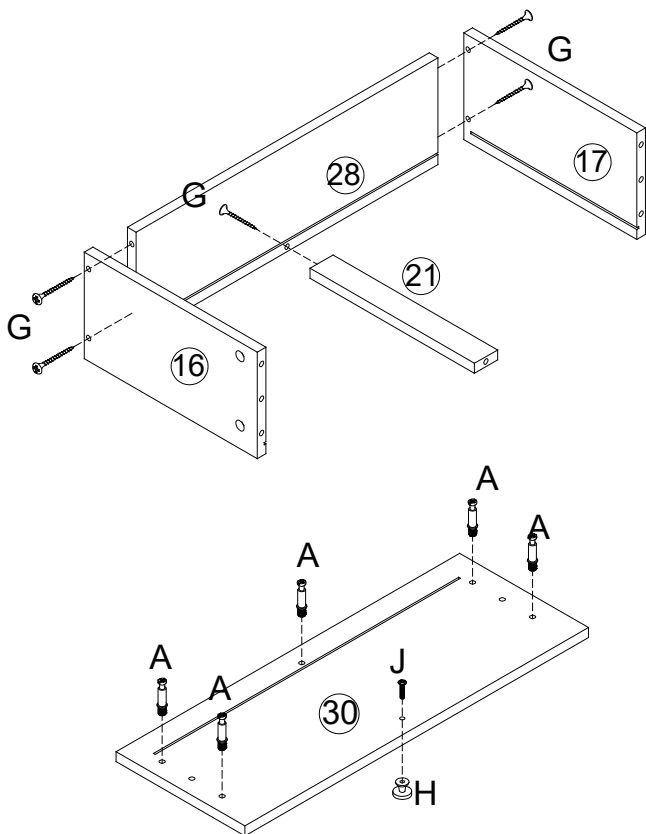

### STEP 15

A		5
G	 4x35	5
J		1
H		1





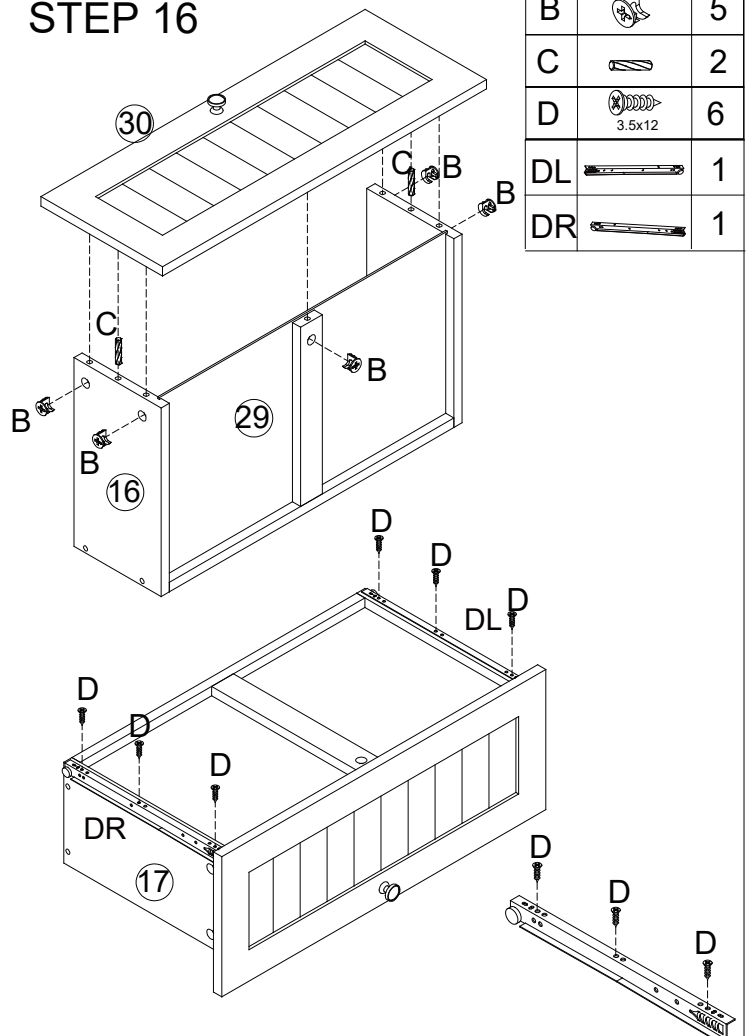

### STEP 16

B		5
C		2
D	 3.5x12	6
DL		1
DR		1





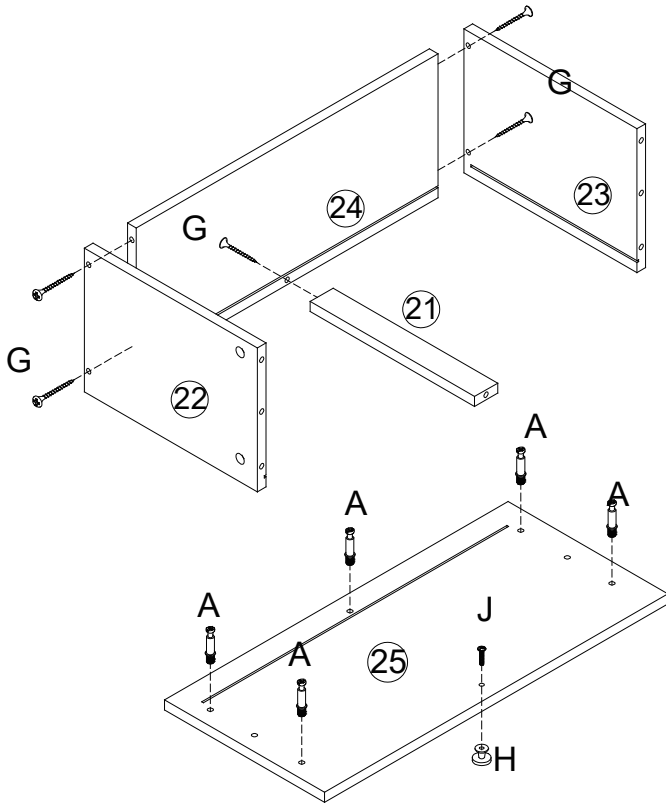

### STEP 17

A		5
G	 4x35	5
J		1
H		1





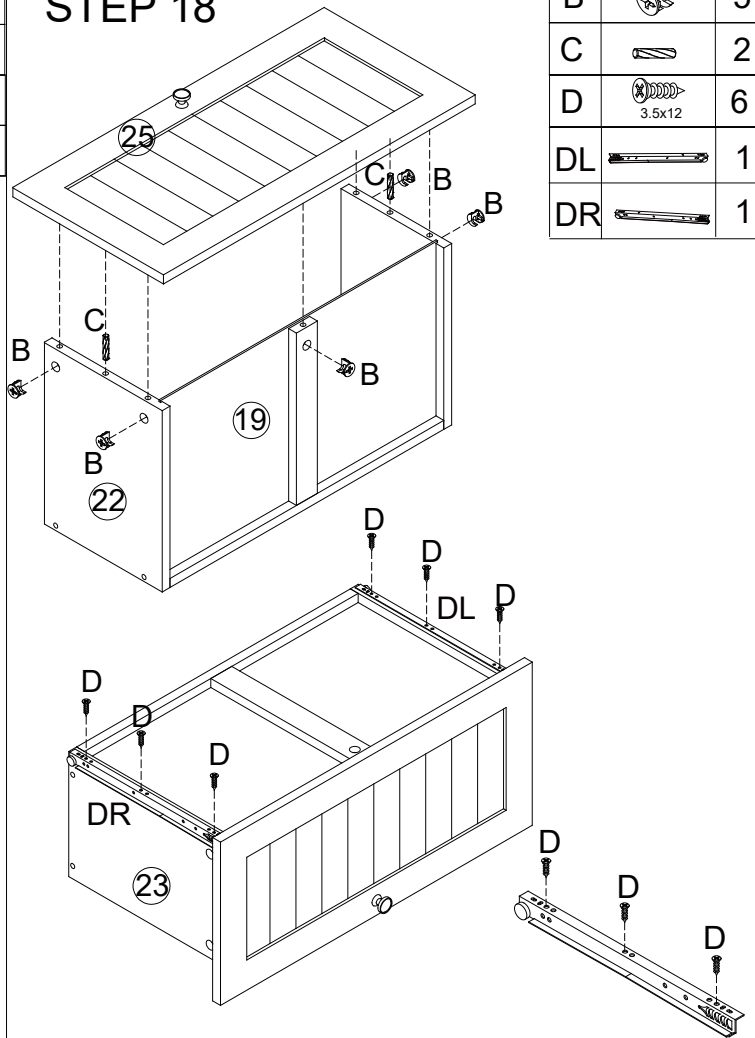

### STEP 18

B		5
C		2
D	 3.5x12	6
DL		1
DR		1



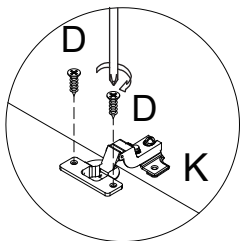
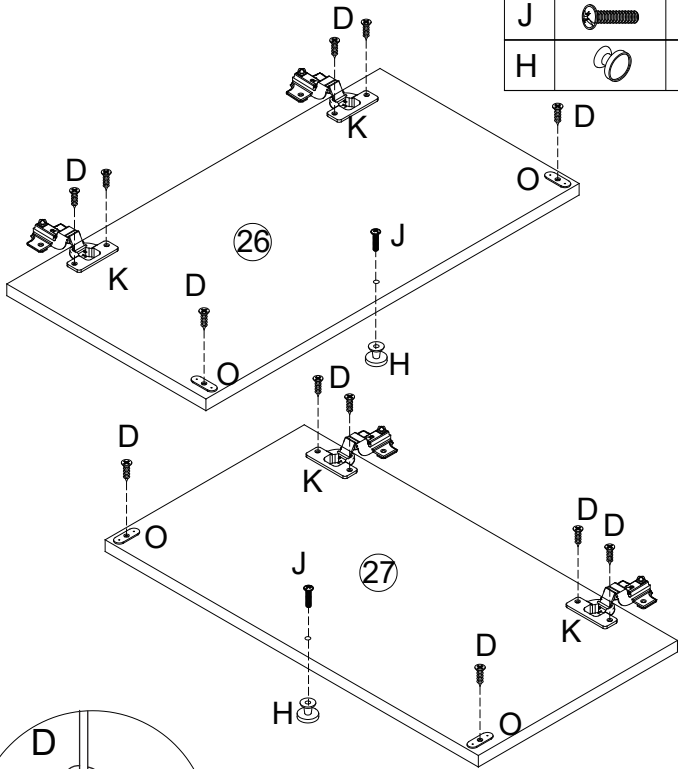

### STEP 19

O		4	D	 3.5x12	12
K		4	J		2
H		2			



### STEP 20

V		4
D	 3.5x12	8

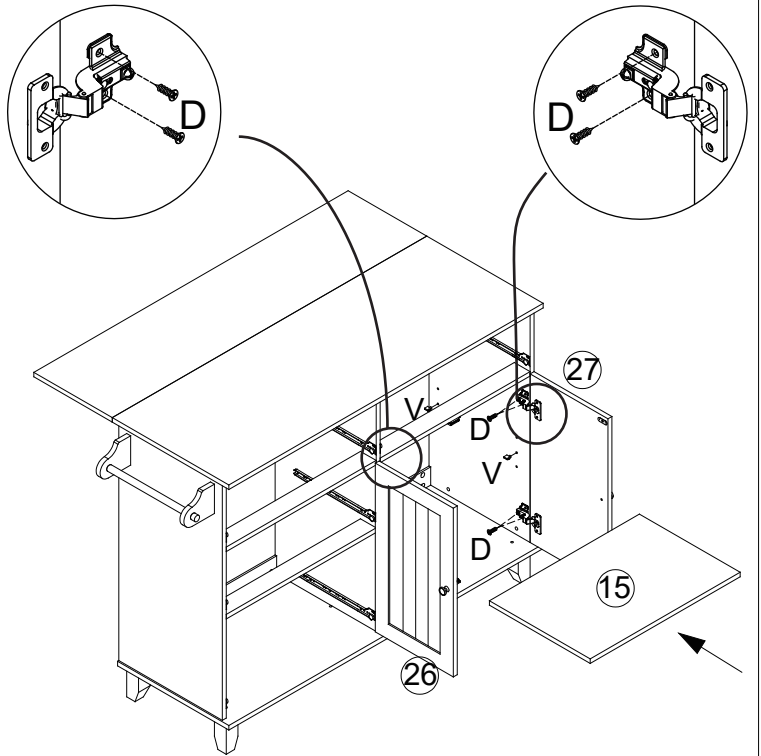

# STEP 21

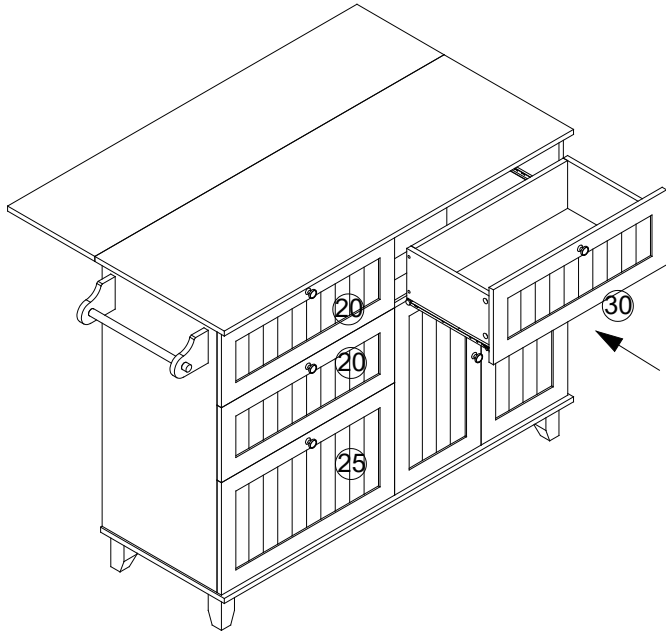

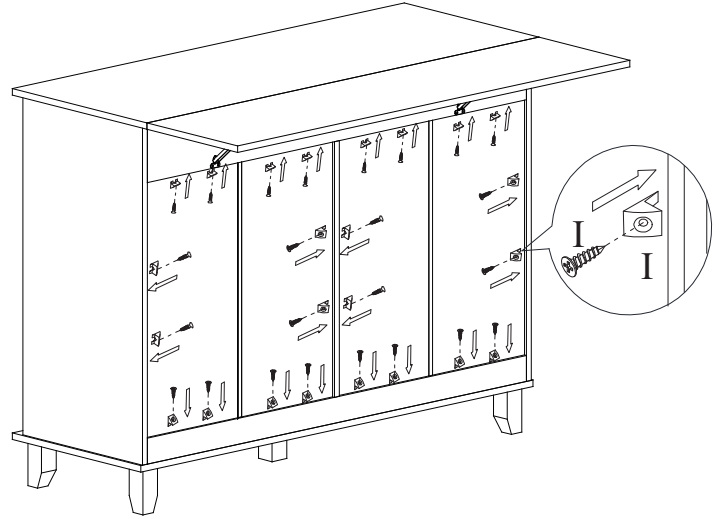

# STEP 22

I		4x16	24
---	--	------	----



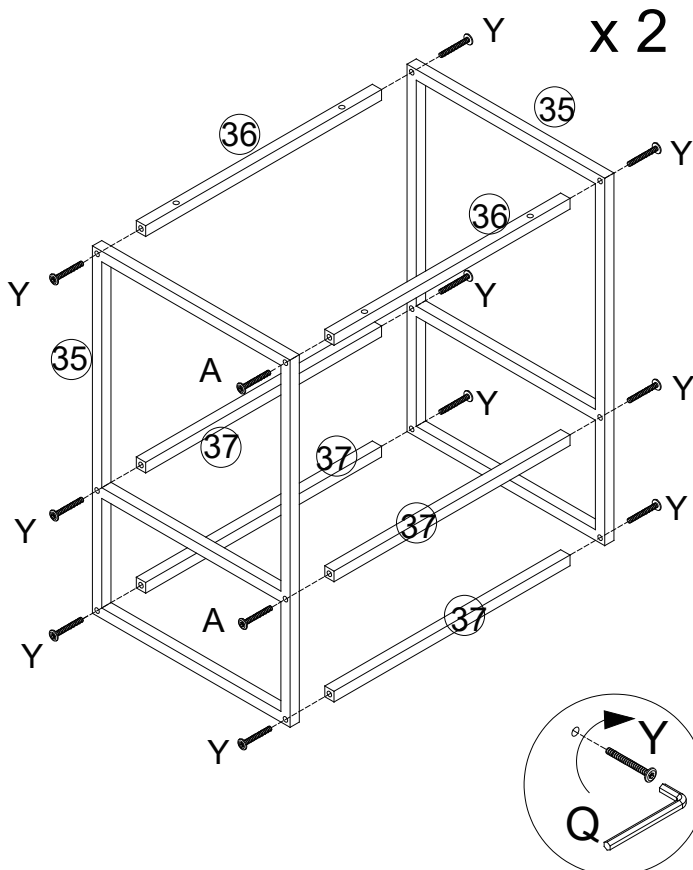

# STEP 23

Y		6 x 40	24
Q			1



# STEP 24

Y		6 x 40	8
Q			1

