

ASSEMBLY INSTRUCTIONS

ITEM NO. FB3015CST-GY-SC-4PK
FB3015CST-WA-SC-4PK

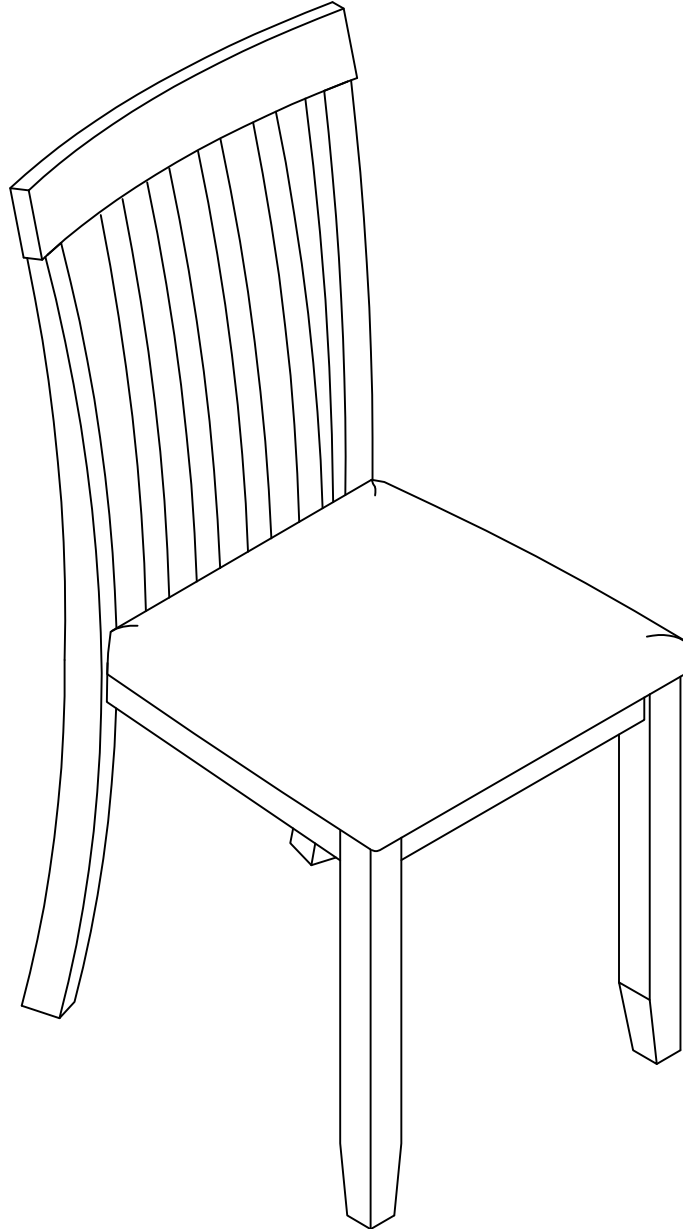

ASSEMBLY TIPS:

1. Remove hardware from box and sort by size.
2. Please check to see that all hardware and parts are present prior to start of assembly.
3. Please follow attached instructions in the same sequence as numbered to assure fast & easy assembly.



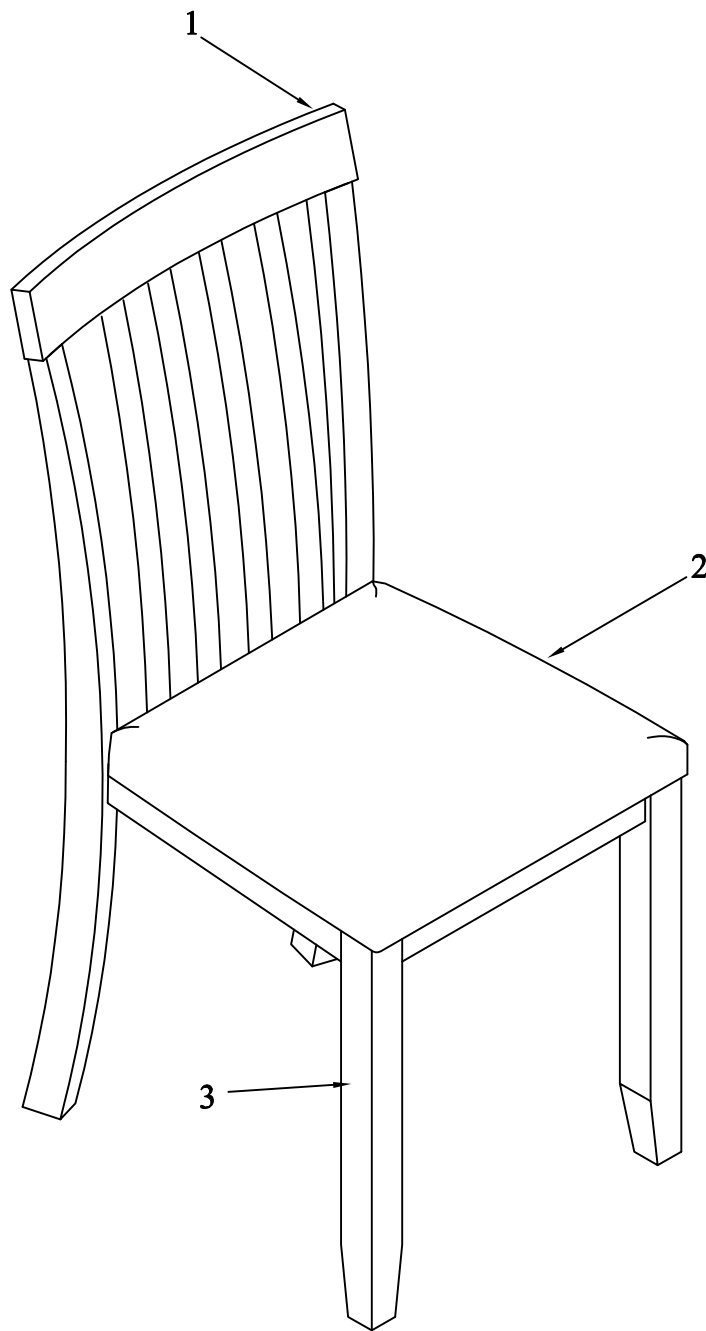

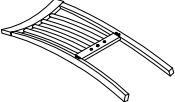
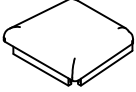
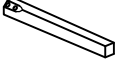

Exploded View



PARTS LIST

NO.	DIAGRAM	PART NAME	Q'Ty
1		CHAIR BACK	1PC
2		SEAT FRAME WITH CUSHION	1PC
3		LEG	2PCS

HARDWARE LIST

NO.	DIAGRAM	PART NAME	Q'Ty
A		BOLT / BOULON Ø1/4" x 1-1/2"	2PCS
B		BOLT / BOULON Ø1/4" x 2-3/8"	4PCS
C		BOLT / BOULON Ø1/4" x 3"	4PCS
D		LOCK WASHER Ø1/4"	10PCS
E		FLAT WASHER Ø1/4"x 3/4"	10PCS
F		ALLEN KEY 1/6" x 2-1/4"	1PC

STEP 1:

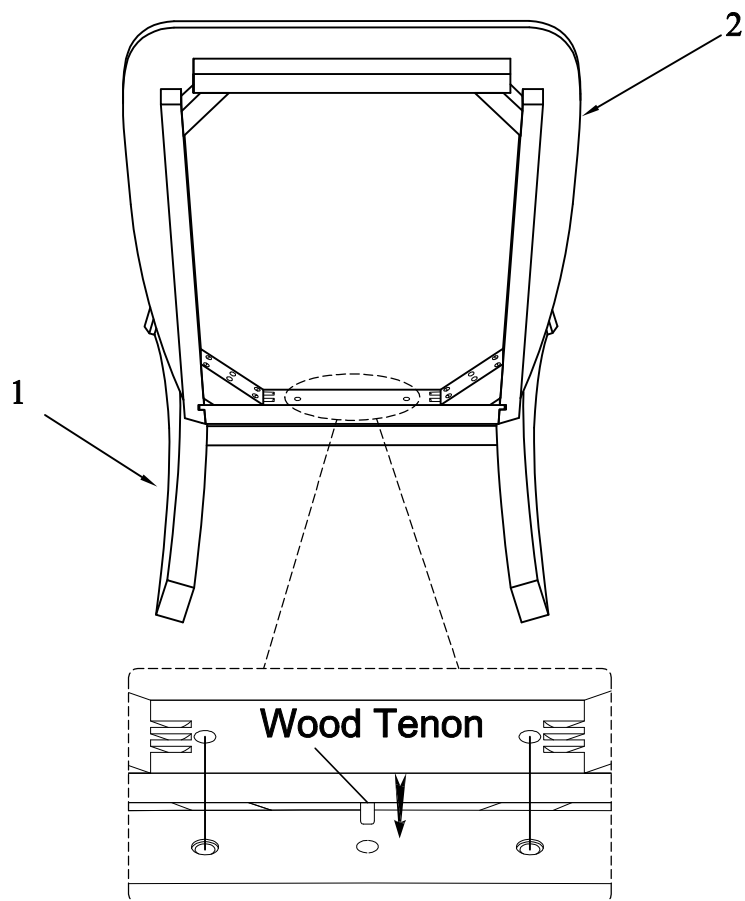

STEP 2:

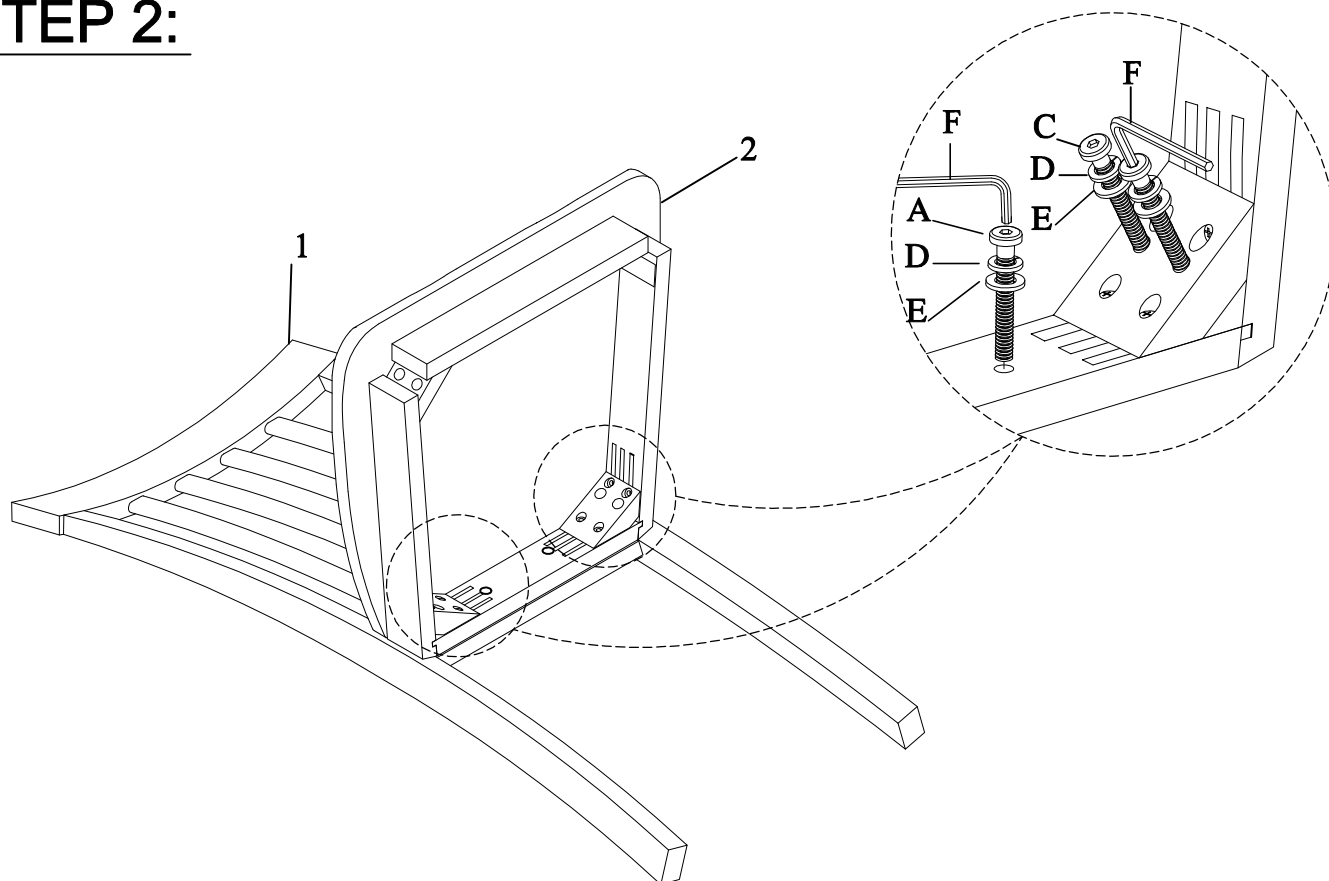

STEP 3:

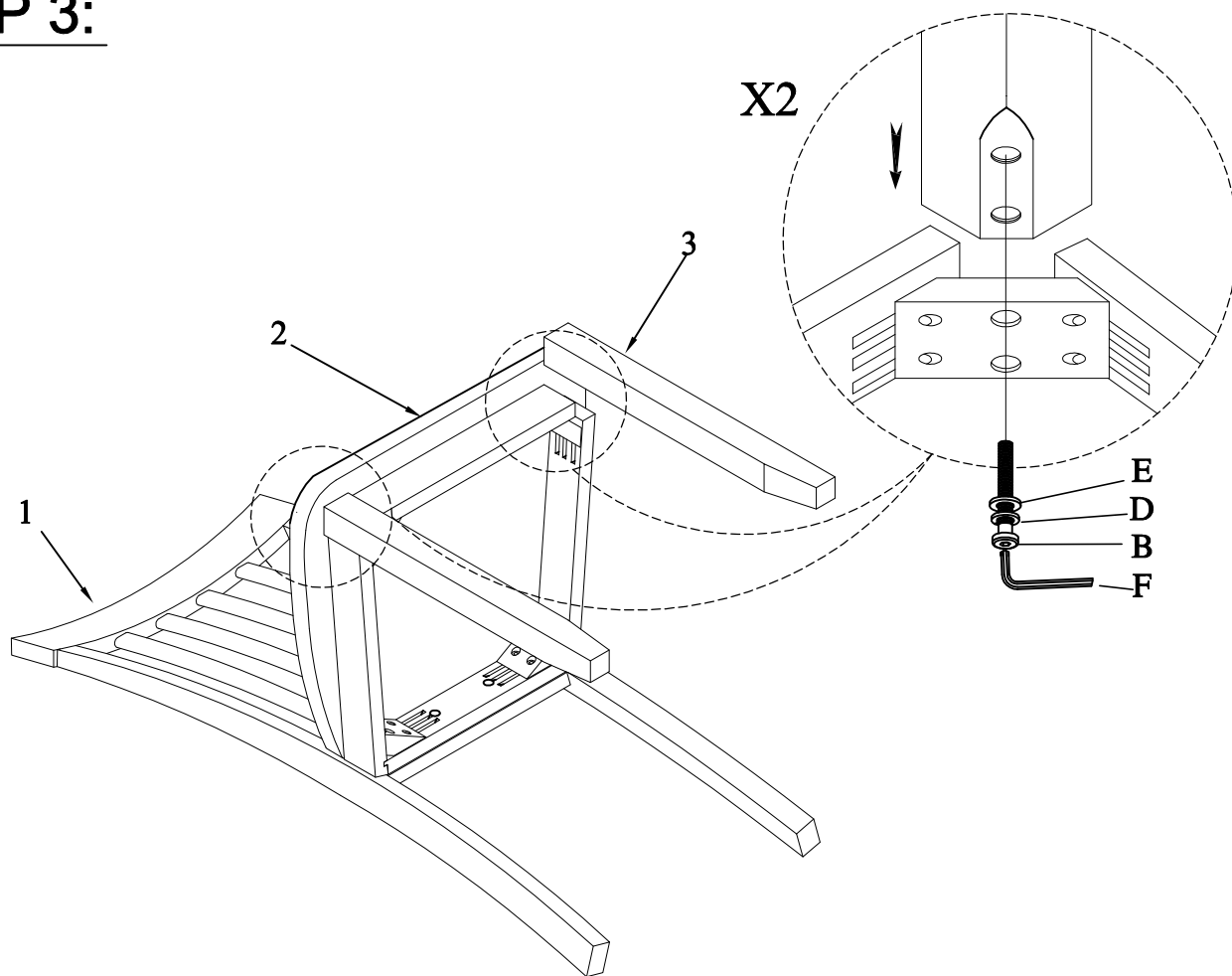

COMPLETED :

