

ASSEMBLY INSTRUCTIONS

ITEM NO. FB3011CST-GY-T-2946
FB3011CST-WA-T-2946

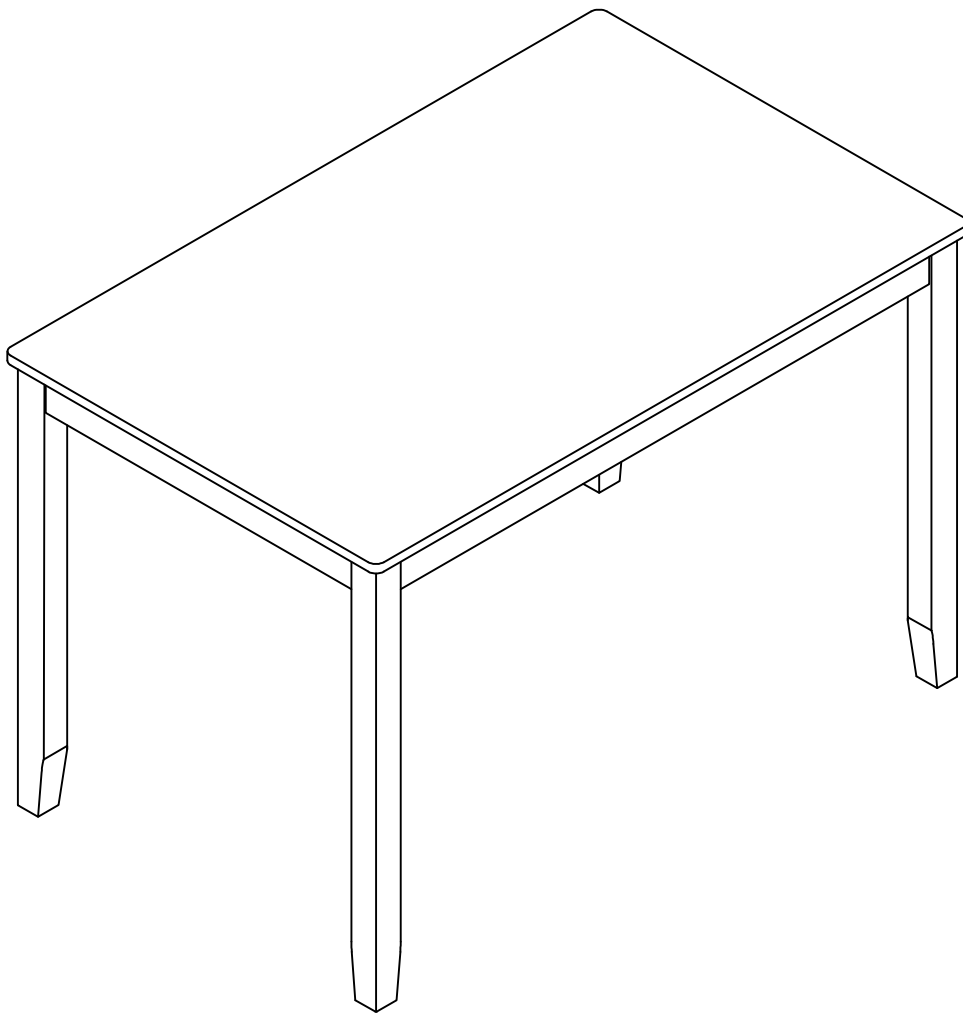



ASSEMBLY TIPS:

1. Remove hardware from box and sort by size.
2. Please check to see that all hardware and parts are present prior to start of assembly.
3. Please follow attached instructions in the same sequence as numbered to assure fast & easy assembly.

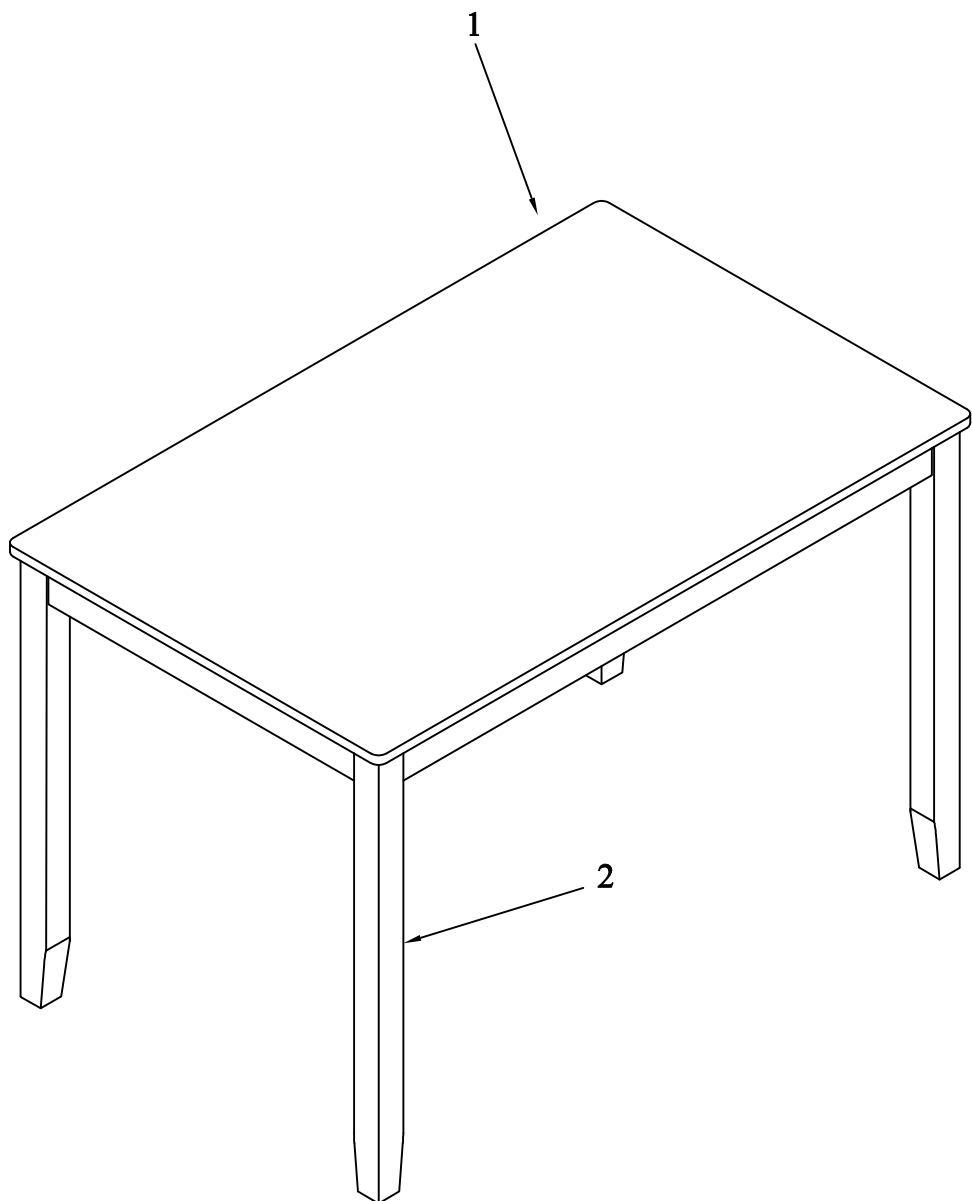

Exploded View



PARTS LIST

NO.	DIAGRAM	PART NAME	Q'Ty
1		TABLE TOP	1PC
2		LEG	4PCS

HARDWARE LIST

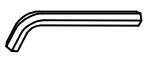
NO.	DIAGRAM	PART NAME	Q'Ty
A		BOLT / BOULON Ø5/16" x2-3/8"	8PCS
B		LOCK WASHER Ø5/16"1/16	8PCS
C		FLAT WASHER Ø5/16"x 19mm	8PCS
D		ALLEN KEY 1/6" x 2-1/4"	1PC

STEP 1:

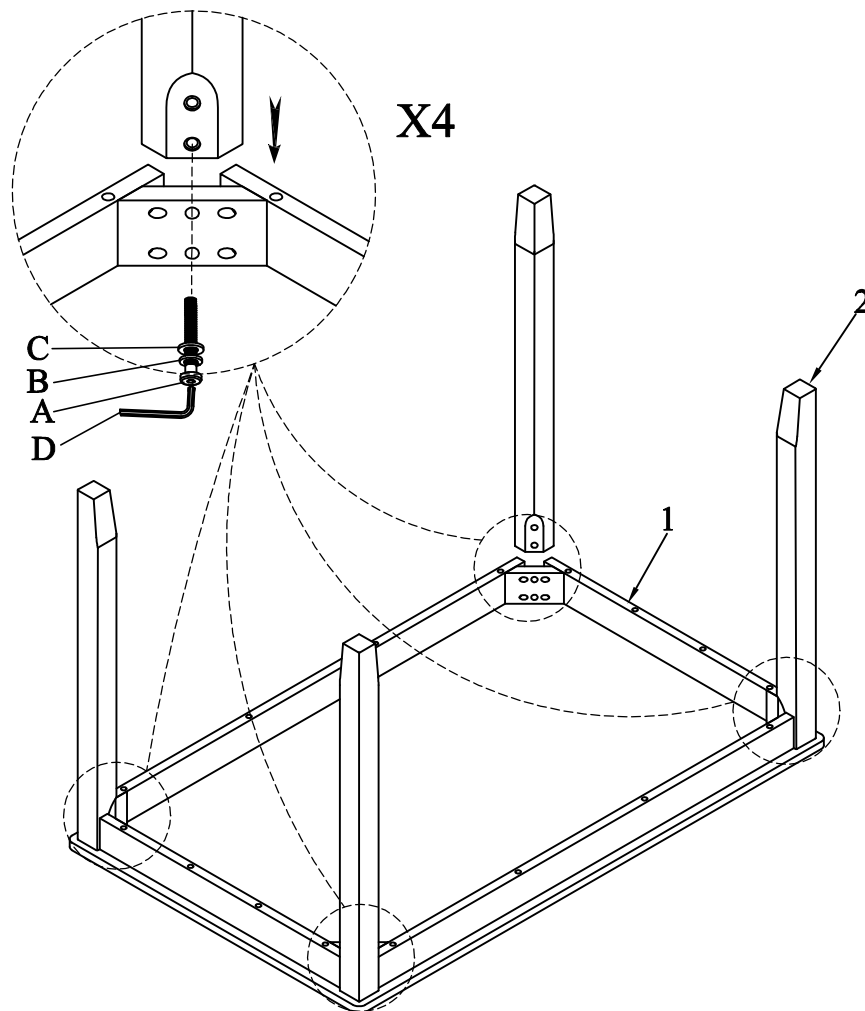

COMPLETED :

