

# ASSEMBLY INSTRUCTIONS

ITEM NO. Functional Recliner Chair FB6010DC-PWR

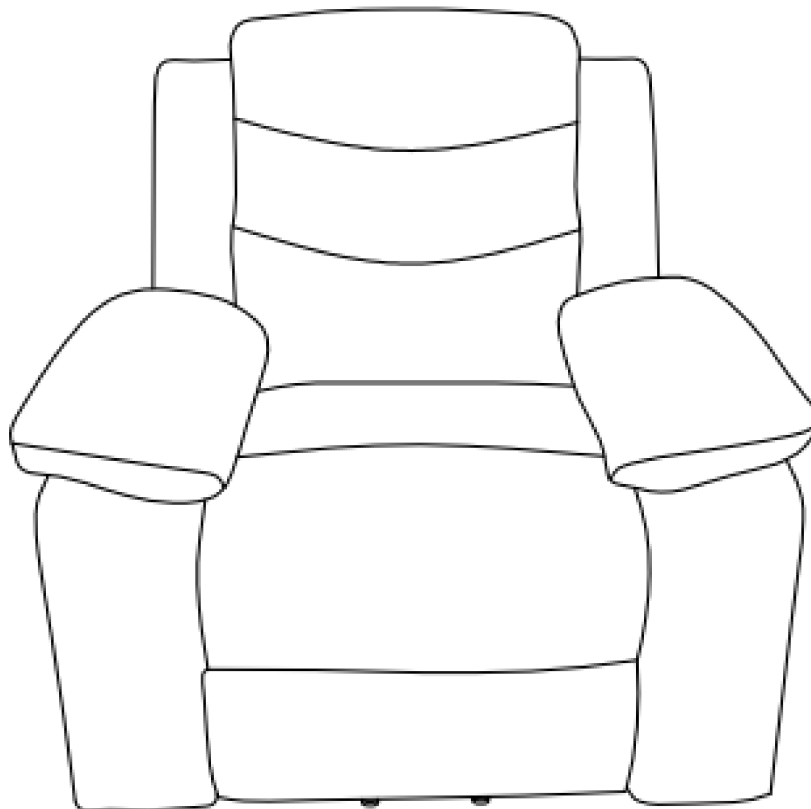



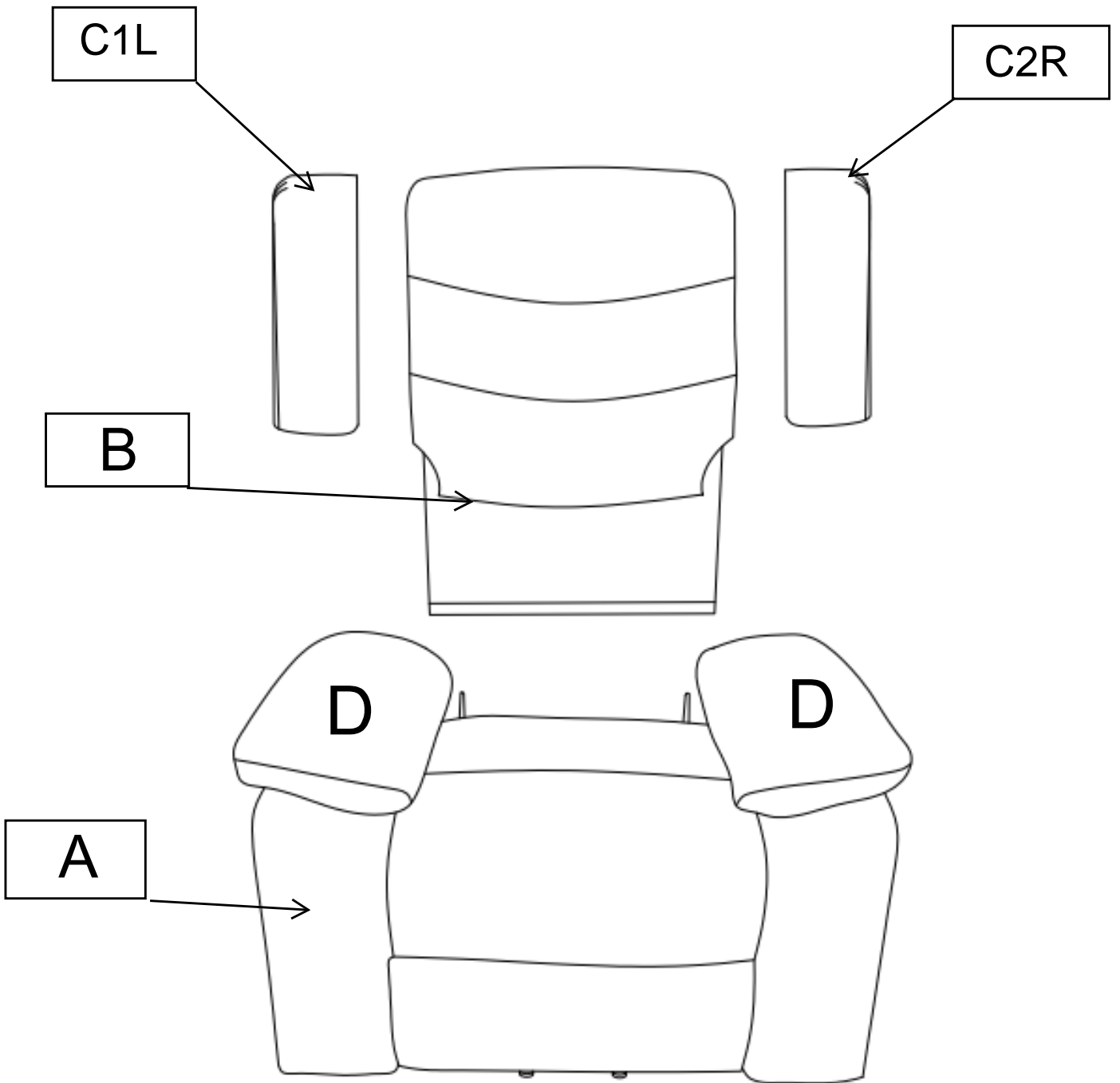

**IMPORTANT NOTE:**

- ① PLACE ALL PARTS ON A CLEAN AND SMOOTH SURFACE SUCH AS A RUG OR CARPET TO AVOID THE PARTS FROM BEING SCRATCHED.
- ② BEFORE YOU BEGIN, KINDLY FOLLOW THE ASSEMBLY INSTRUCTIONS STEP BY STEP.

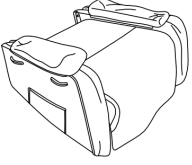
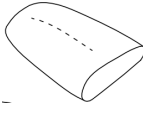
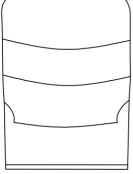

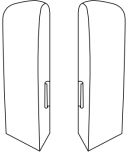
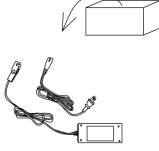
# Part List

<p>Ⓐ</p> 	<p>Ⓓ</p> 
<p>SEAT (1 PC)</p>	<p>ARM CUSHION ( 2 PCS)</p>
<p>Ⓑ</p> 	<p>Ⓔ</p> 
<p>BACKREST (1 PC)</p>	<p>SWITCH ( 1 PC)</p>
<p>Ⓒ</p>  <p>C1L      C2R</p>	<p>Ⓕ</p> 
<p>EARREST (2 PCS)</p>	<p>POWER LINE ( 2 PCS)</p>
	<p>Ⓖ</p>  <p>S-SPRING POCKET ( 1 PC)</p>

## STEP 1:

Warning: Please be careful when cutting the wrapping tape!!!

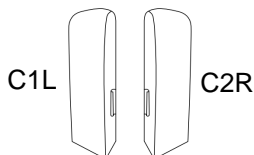
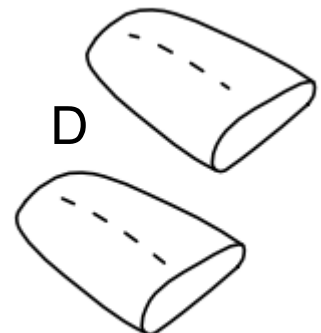
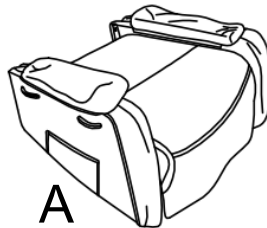
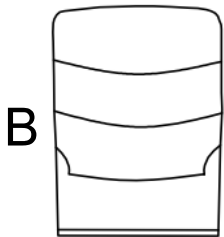
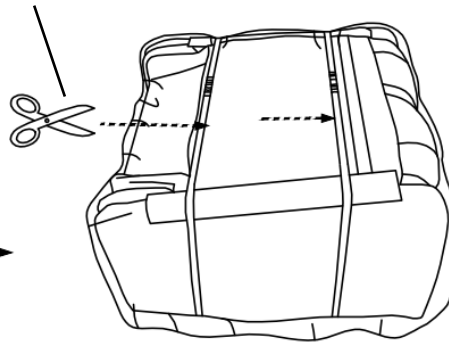
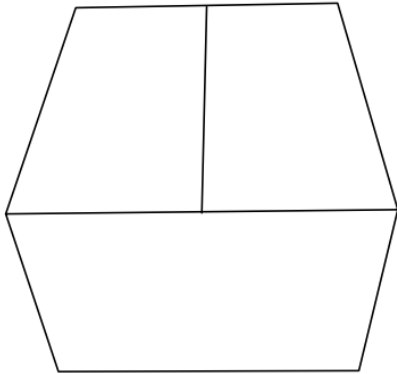

## STEP 2:

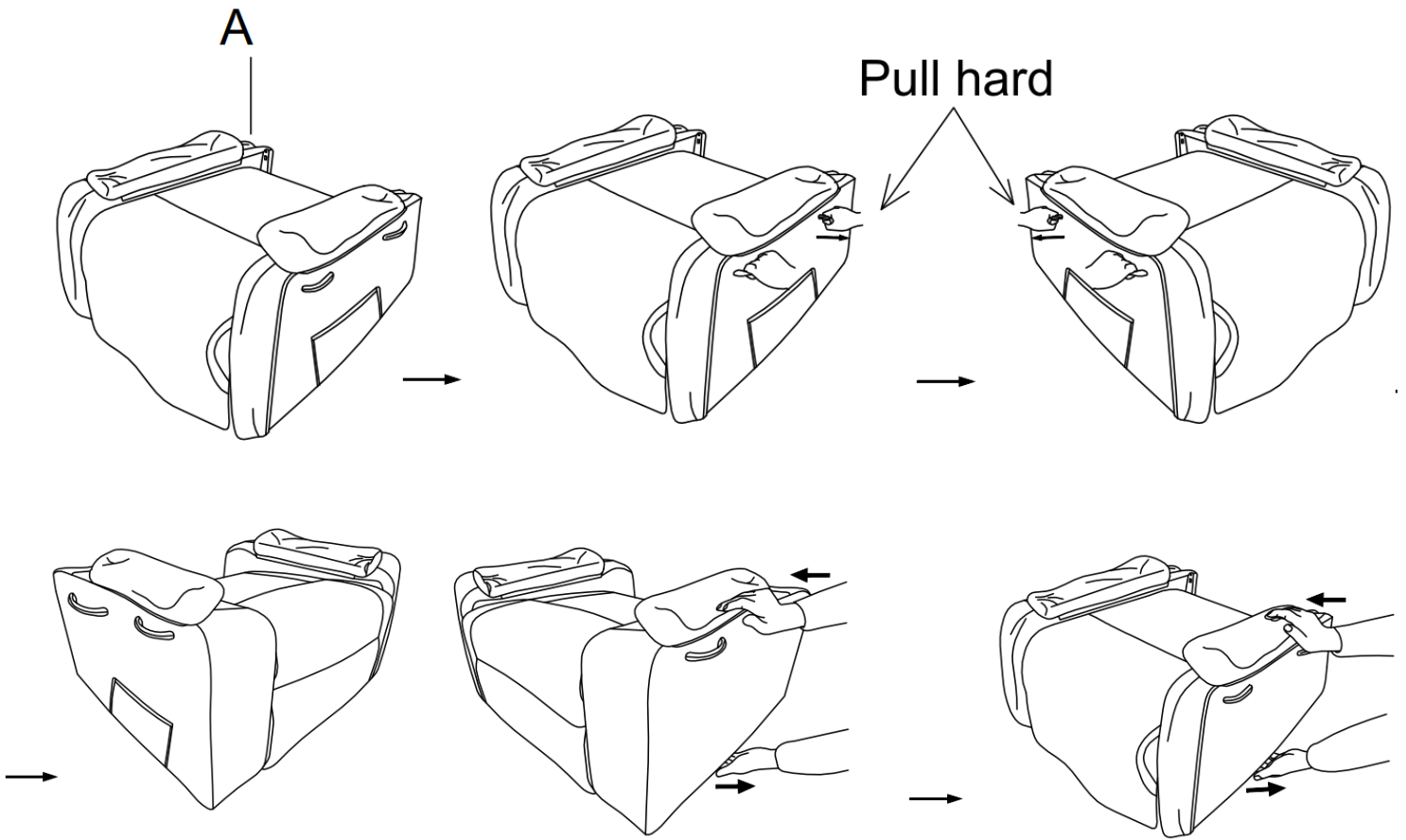

## STEP 3:

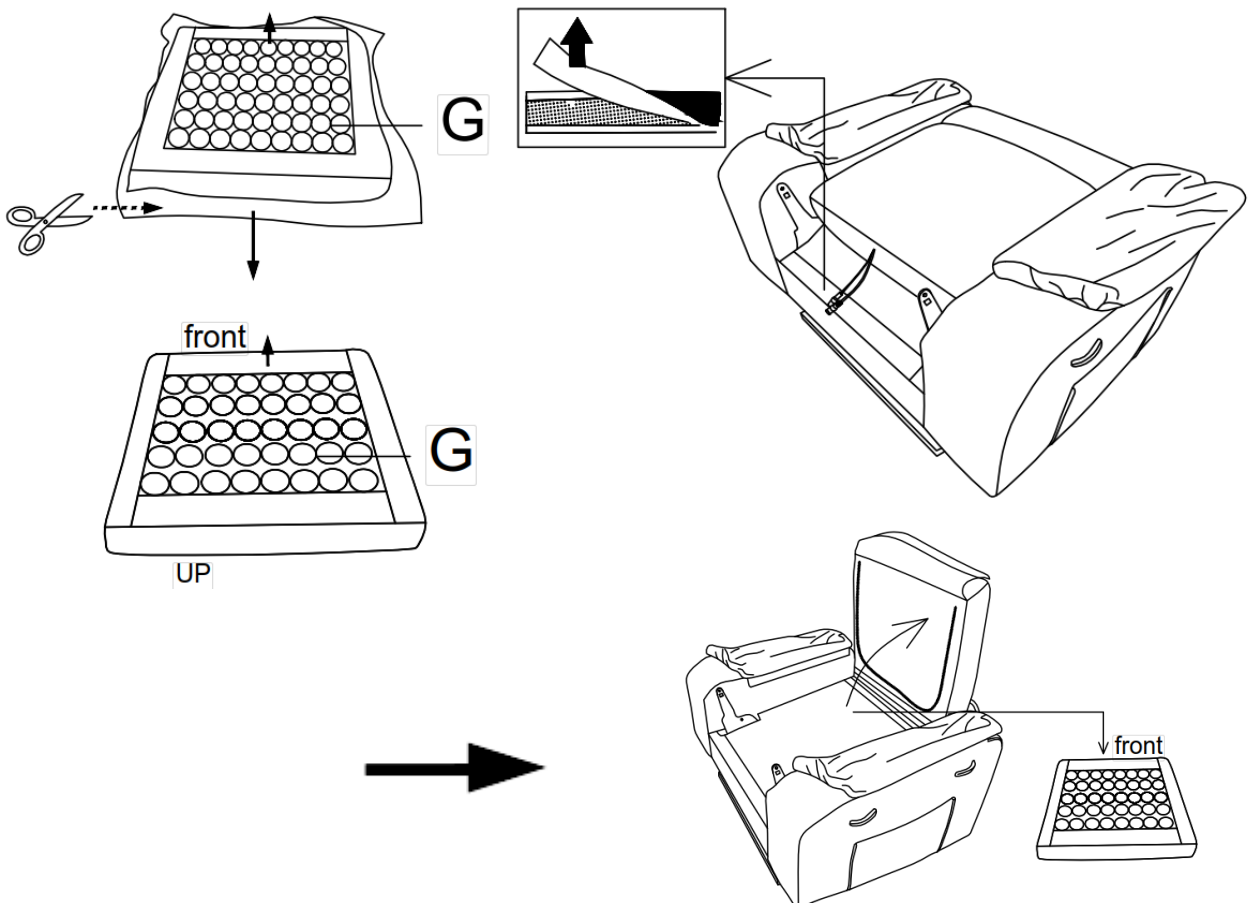

# STEP 4:

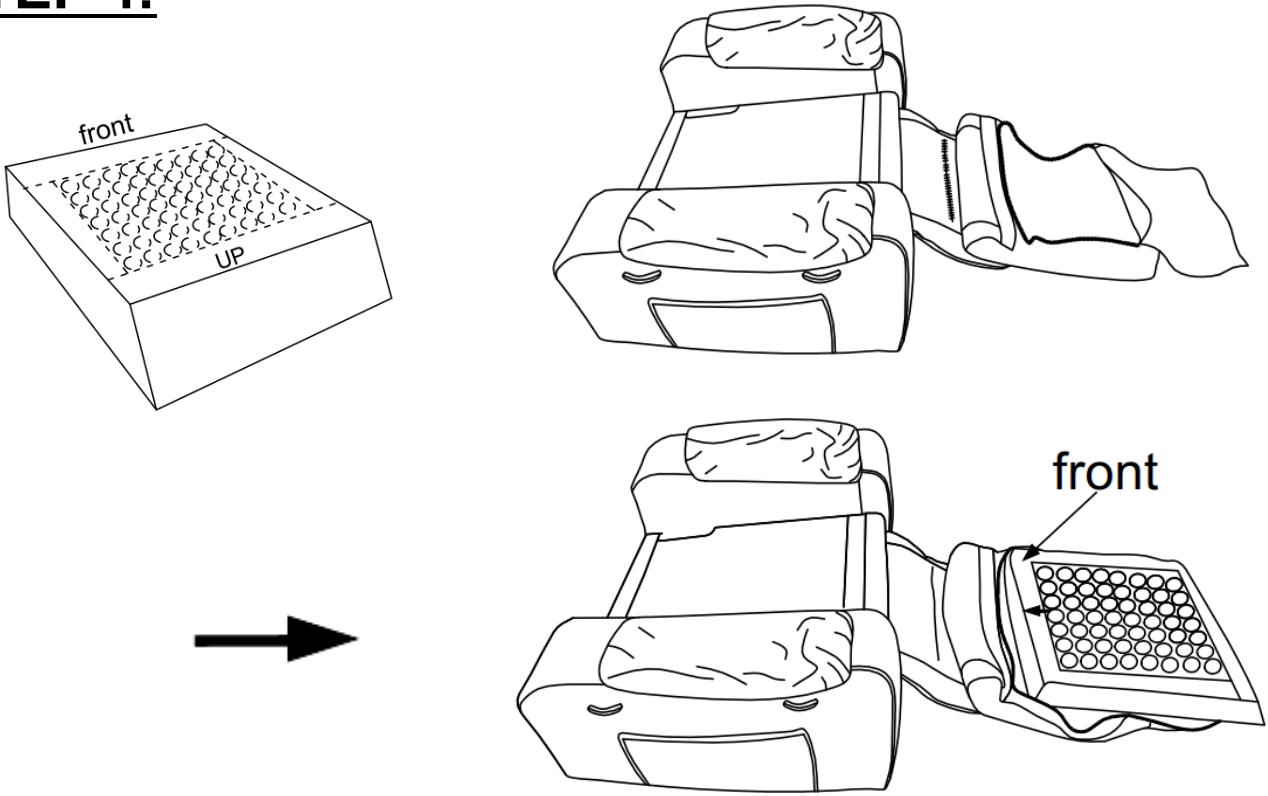

# STEP 5:

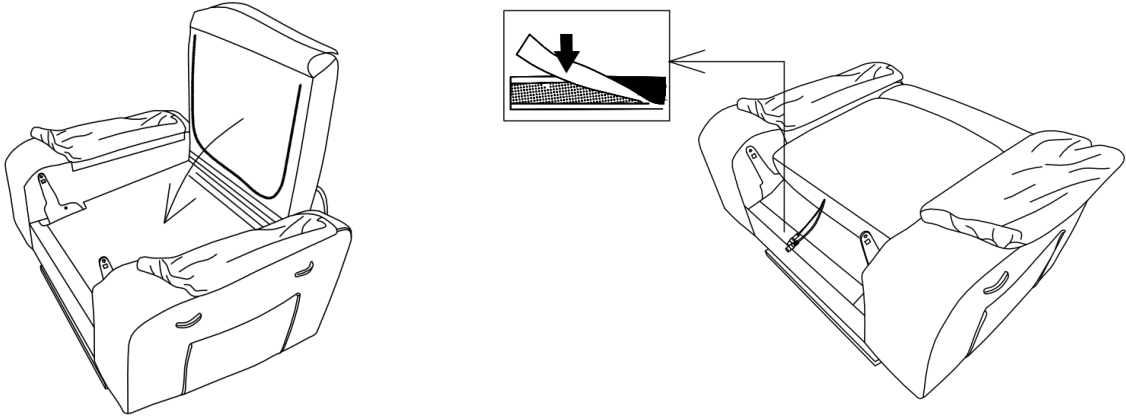

# STEP 6:

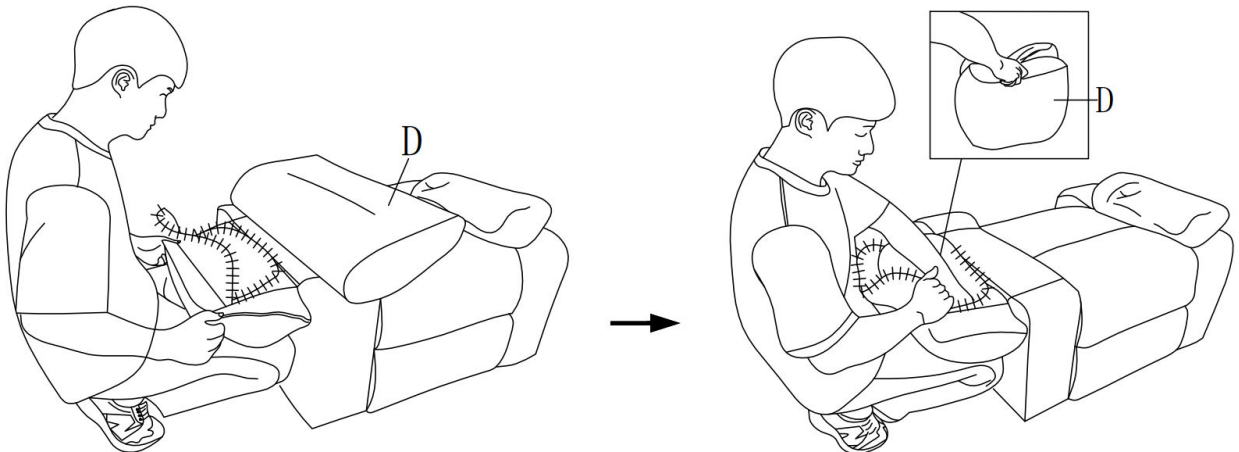

# STEP 7:

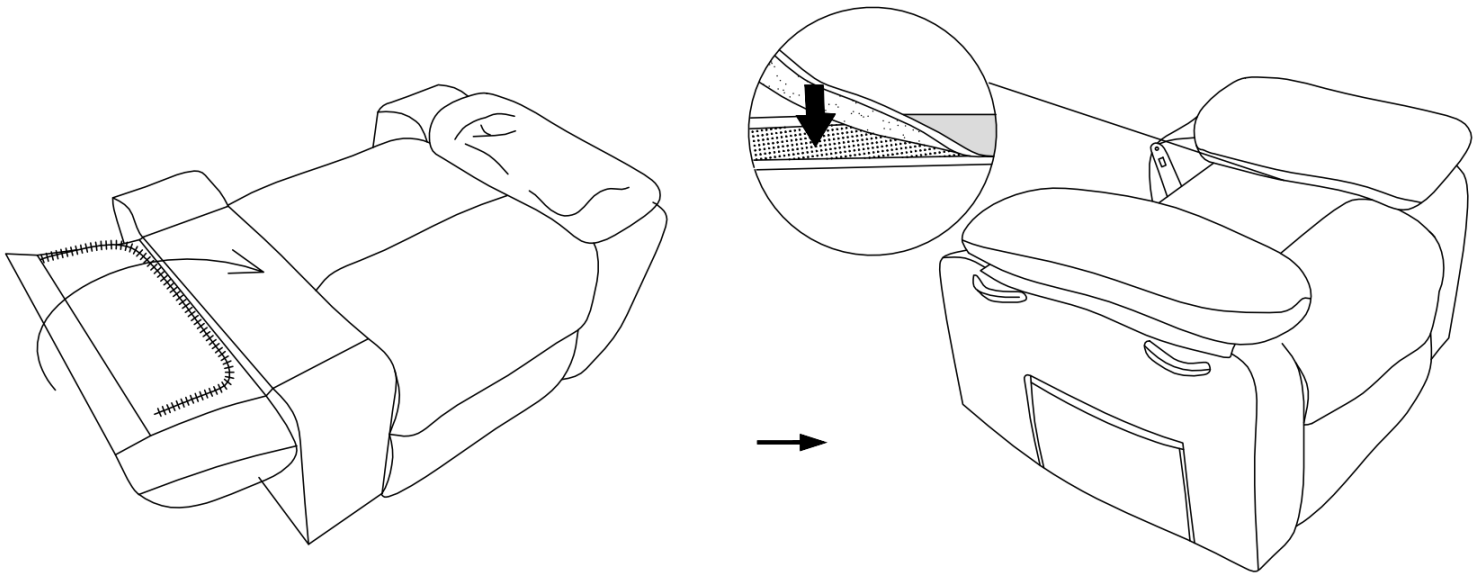

# STEP 8:

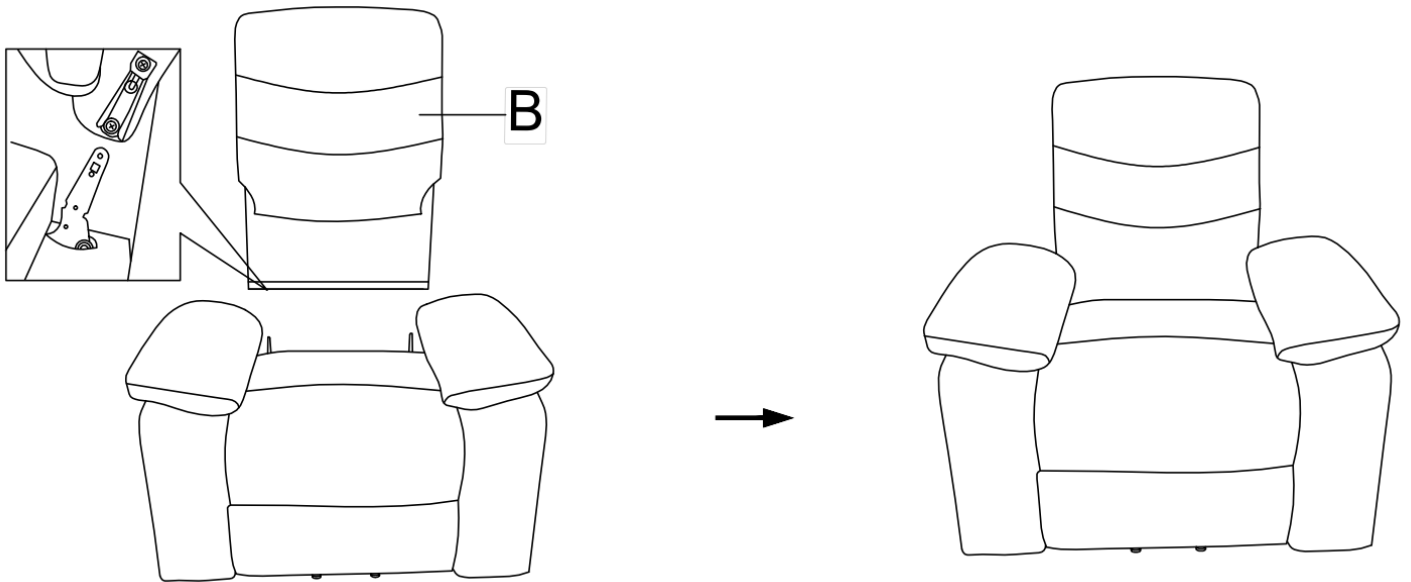

# STEP 9:

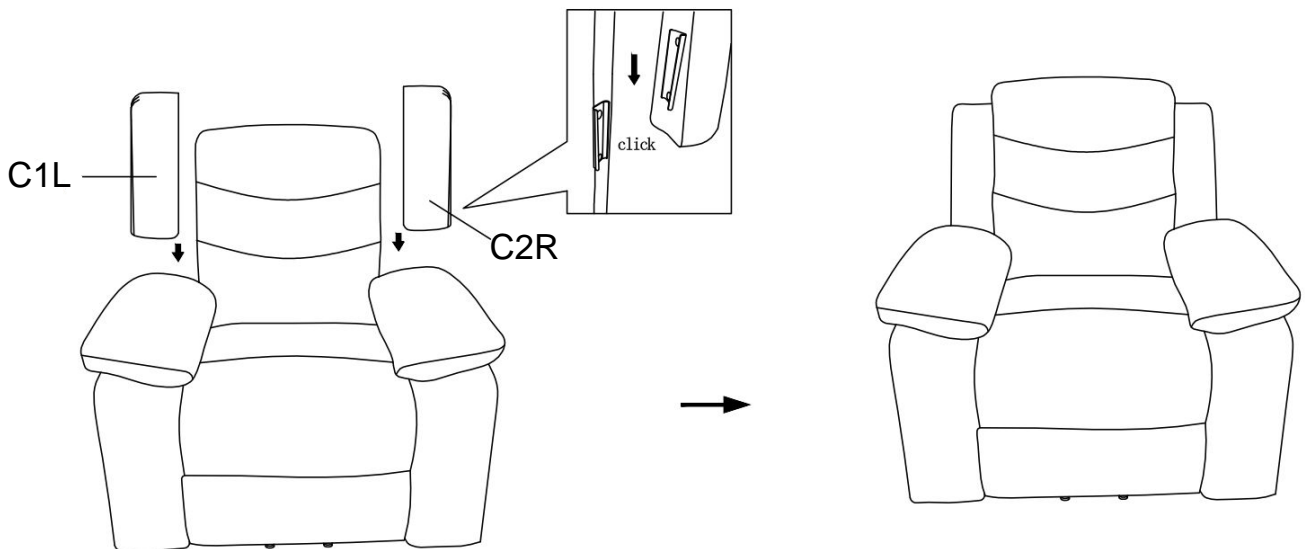

# STEP 10:

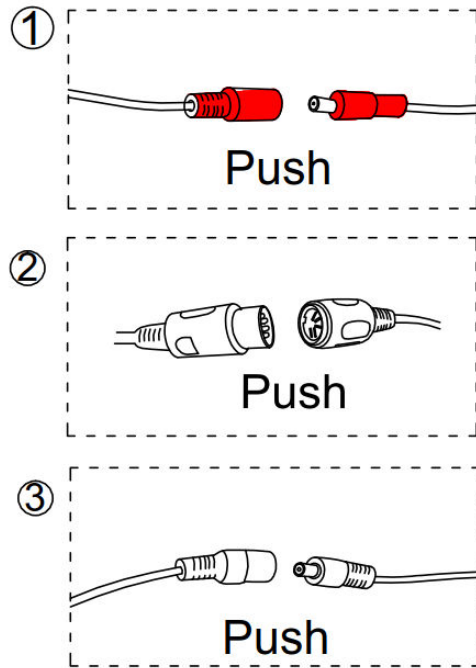
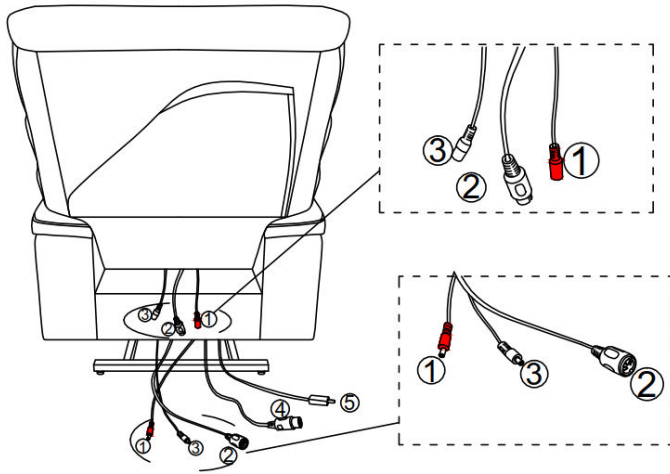

# STEP 11:

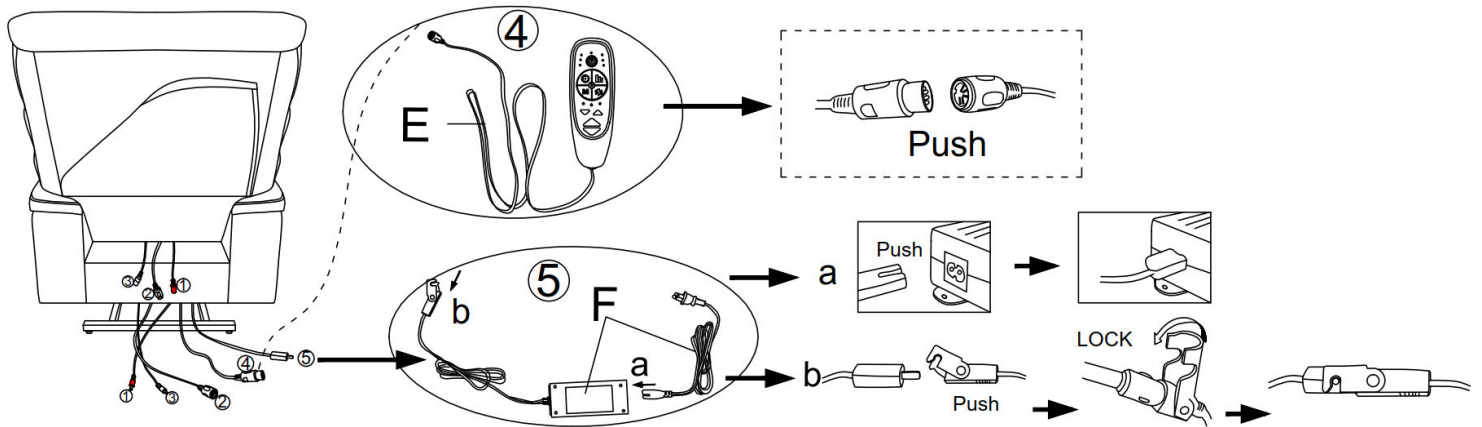

# STEP 12:

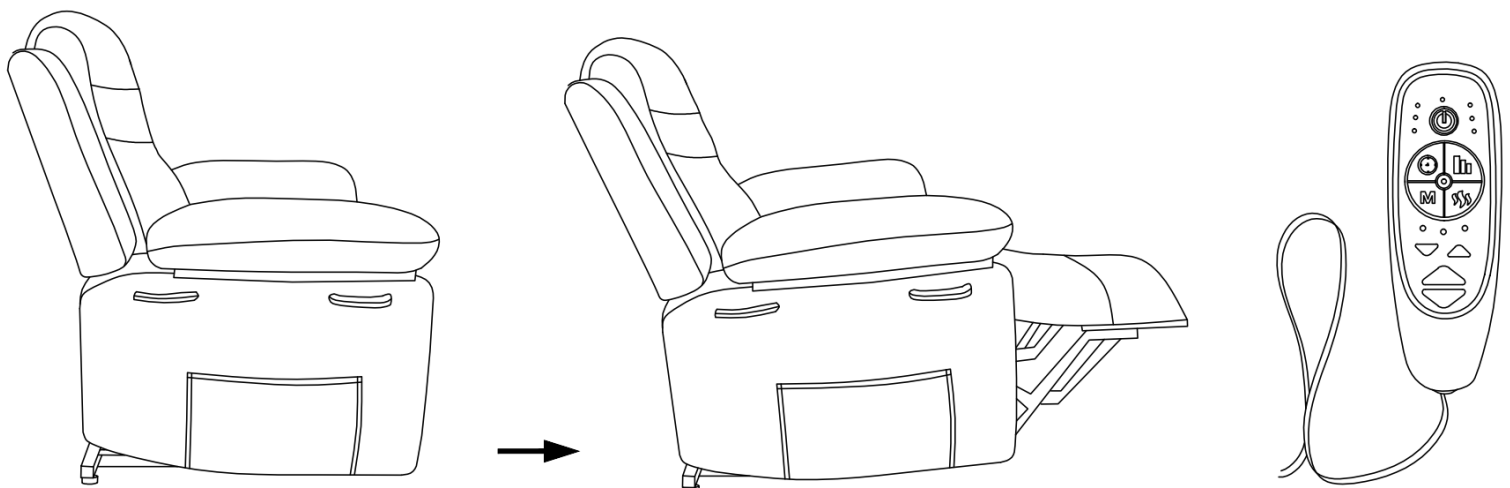

# COMPLETED :

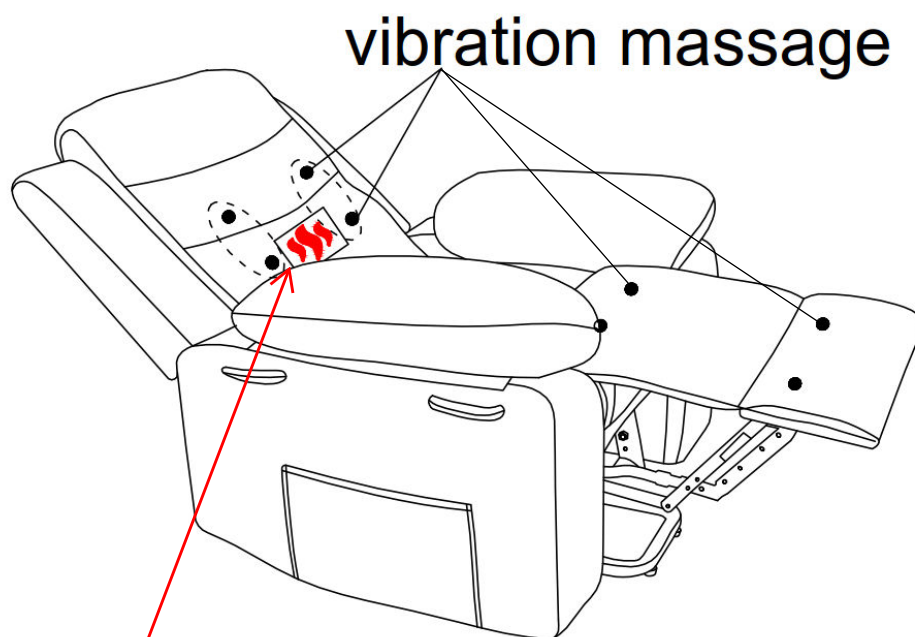
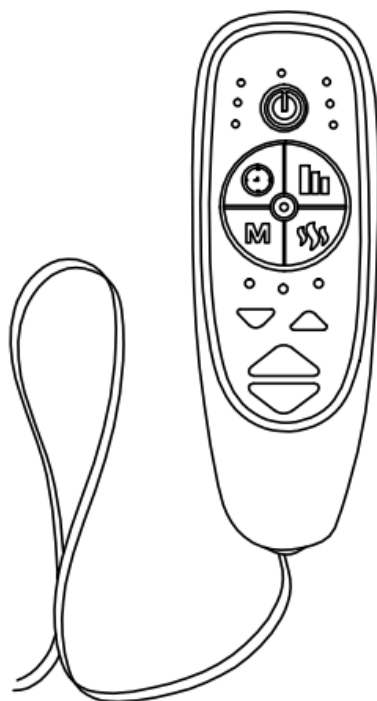

Heating  
function

vibration massage