

# Assembly Instructions

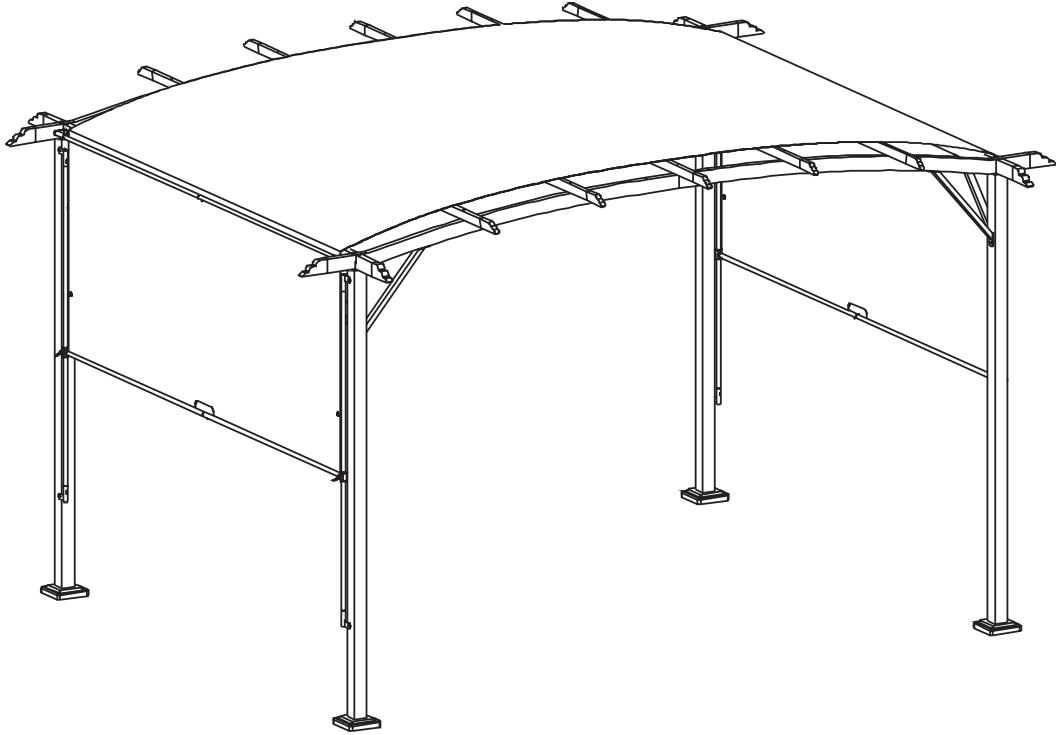

## Before You Start

- ⦿ Please read all instructions carefully.
- ⦿ Retain instructions for future reference.
- ⦿ Separate and count all parts and hardware.
- ⦿ Read through each step carefully and follow the proper order.
- ⦿ We recommend that, where possible, all items are assembled near to the area in which they will be placed in use, to avoid moving the product unnecessarily once assembled.
- ⦿ Always place the product on a flat, steady and stable surface.
- ⦿ Keep all small parts and packaging materials for this product away from babies and children as they potentially pose a serious choking hazard.











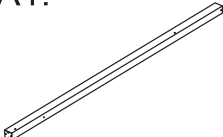
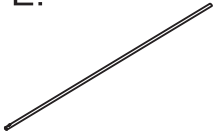

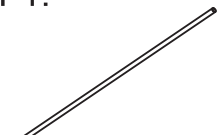
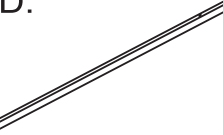
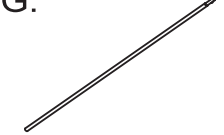
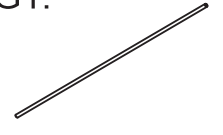





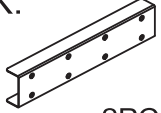

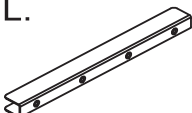

**Note: This gazebo is meant to be used for decorative and sunshade purpose only, not meant to withstand any elements of the weather.**





Please tighten the rope of canopy in each side before using, especially before bad weather.

- 1). Do not cook underneath gazebo.
- 2). Do not ignite fireworks underneath gazebo.
- 3). Please keep the parts list, it could be useful to reorder some parts for service if necessary.

**Please give us a chance to make it right and do better!**

Contact our friendly customer service department for help first. Replacements for missing or damaged parts will be shipped ASAP!

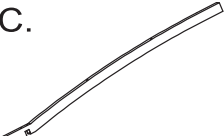
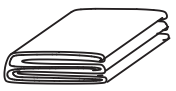
Parts List A				
A.  2PCS	A1.  2PCS	E.  4PCS	F.  2PCS	
F1.  2PCS	D.  10PCS	G.  2PCS	G1.  2PCS	
H.  4PCS	H1.  4PCS	I.  4PCS	I1.  4PCS	
J.  8PCS	J1.  10PCS	K.  2PCS	K1.  2PCS	
L.  5PCS	M.  4PCS	N.  8PCS	P.  2PCS	P1.  2PCS
R.  8PCS	T.  1PC	①  M6x15mm ① x 72PCS	②  M6x55mm ② x 10PCS	③  M6x75mm ③ x 16PCS
④  ④ x 4PCS	U  U x 8PCS	V  V x 8PCS		

Parts List B			
B.  2PCS	B1.  2PCS	C.  4PCS	Q.  1PC
S.  10PCS			

It's better to ask 3-4 persons to help with assembling, and it may takes you about 2 hours to asemmble this gazebo.

# STEP 1

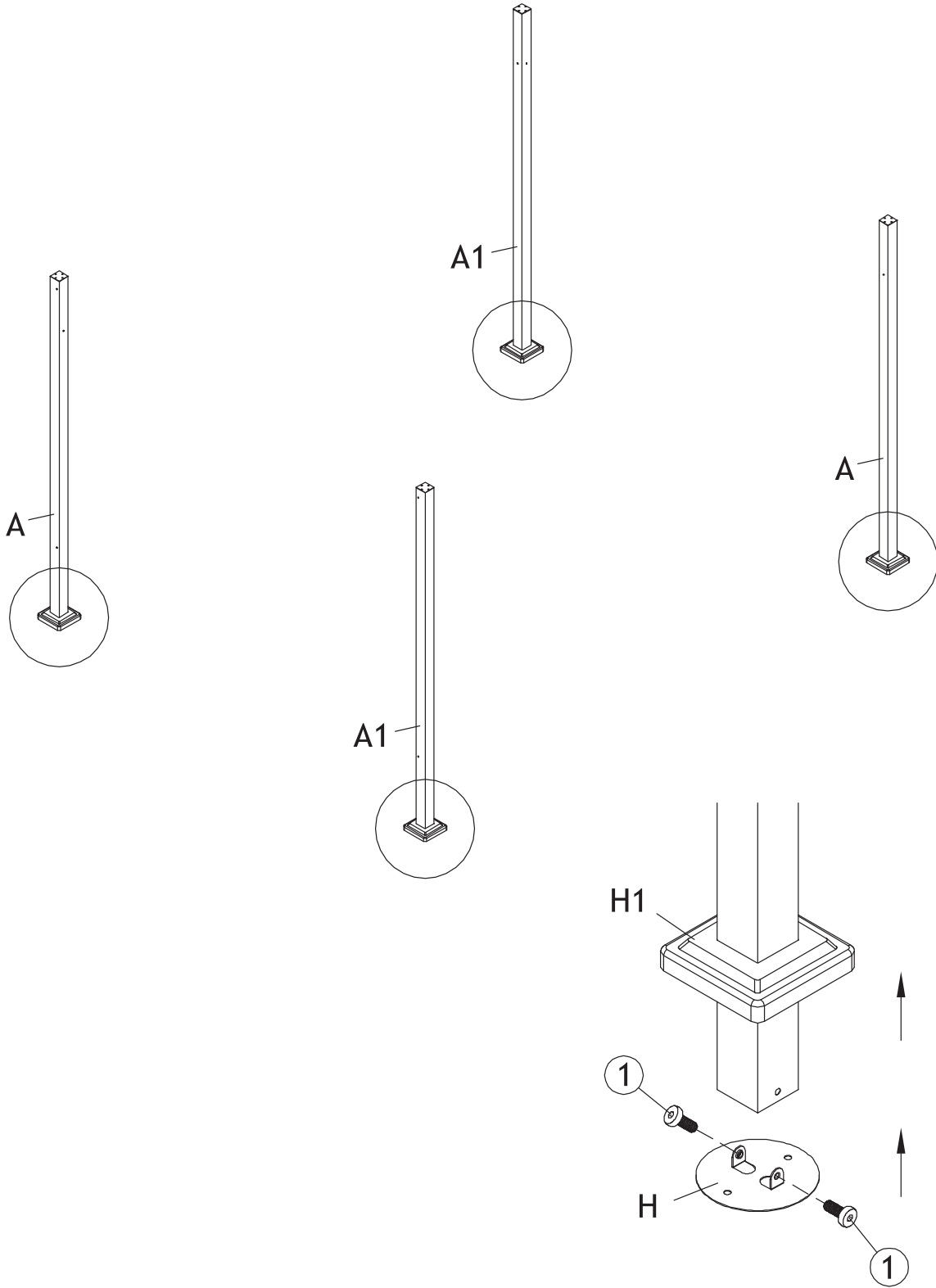

**STEP 2** Please tighten the rope of canopy in each side before using, especially before bad weather.

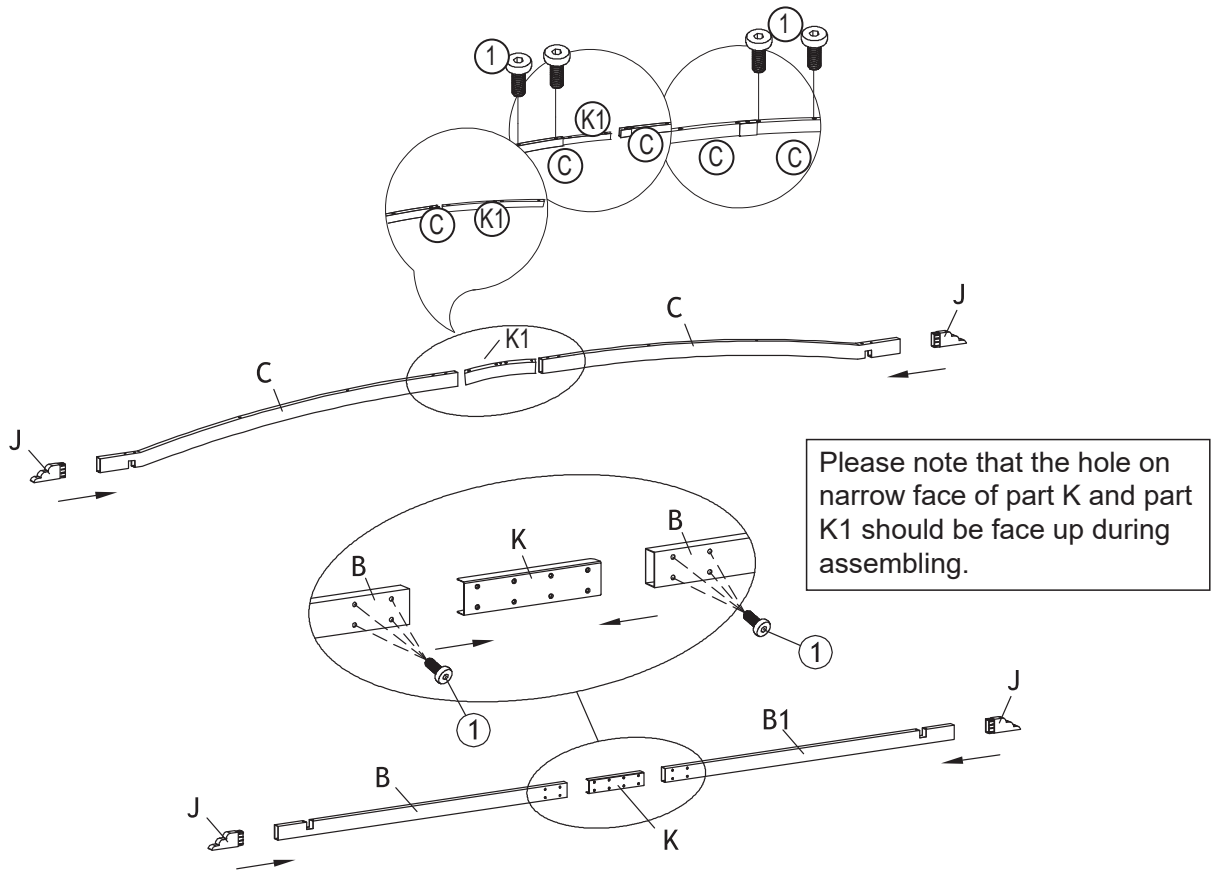

**STEP 3**

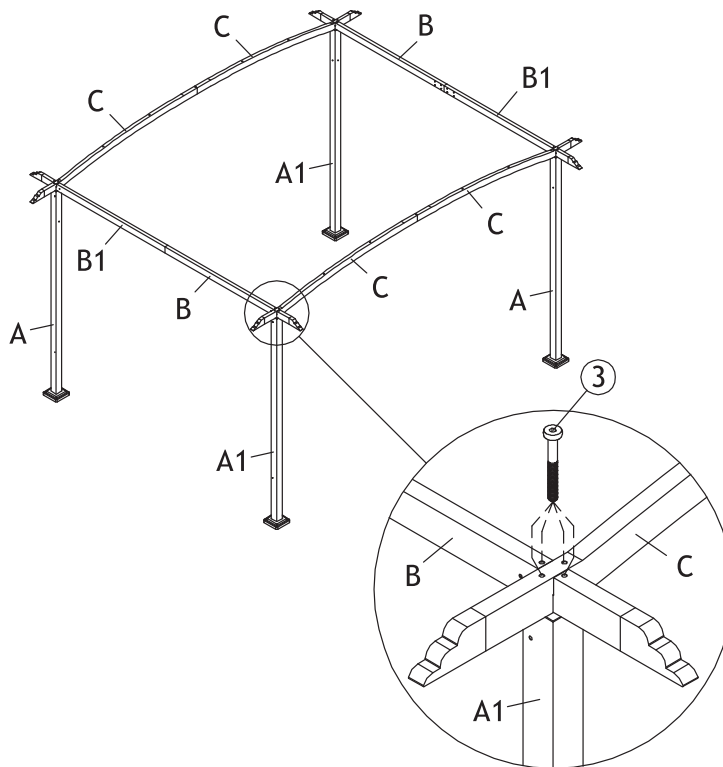

## STEP 4

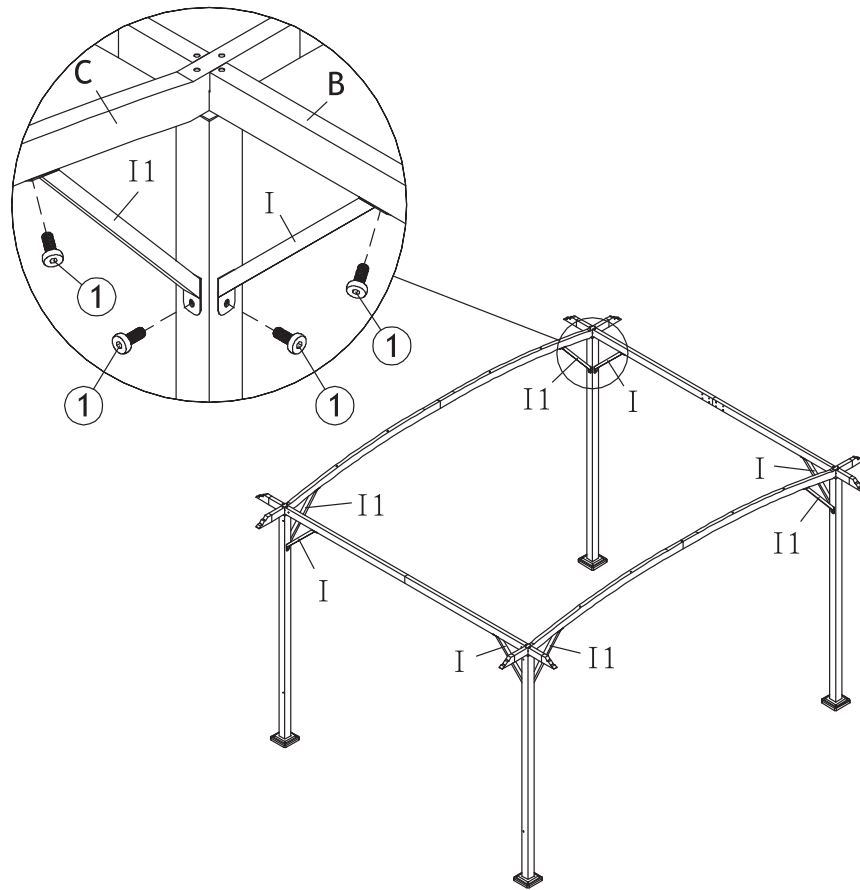

**STEP 5** Please tighten the rope of canopy in each side before using, especially before bad weather.

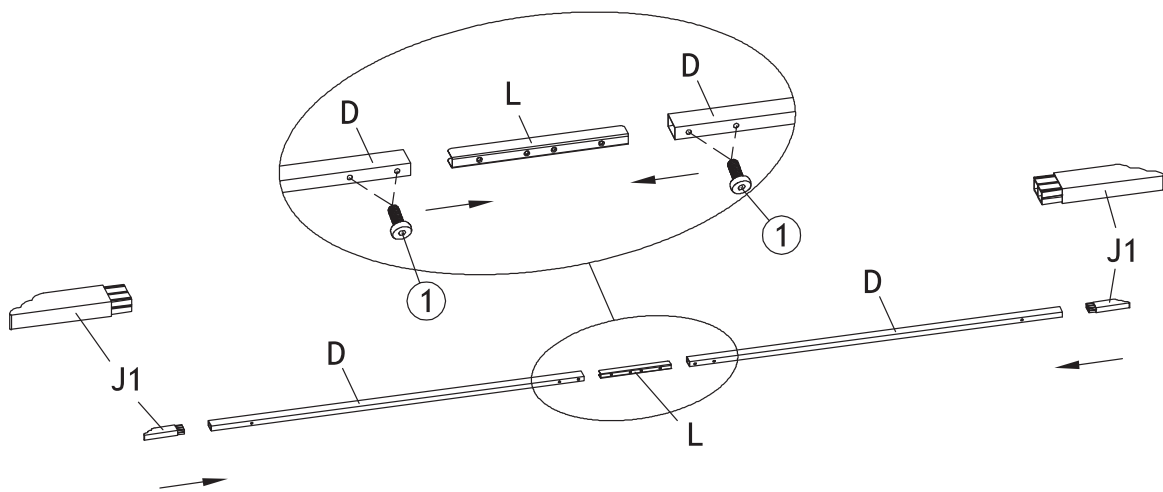

# STEP 6

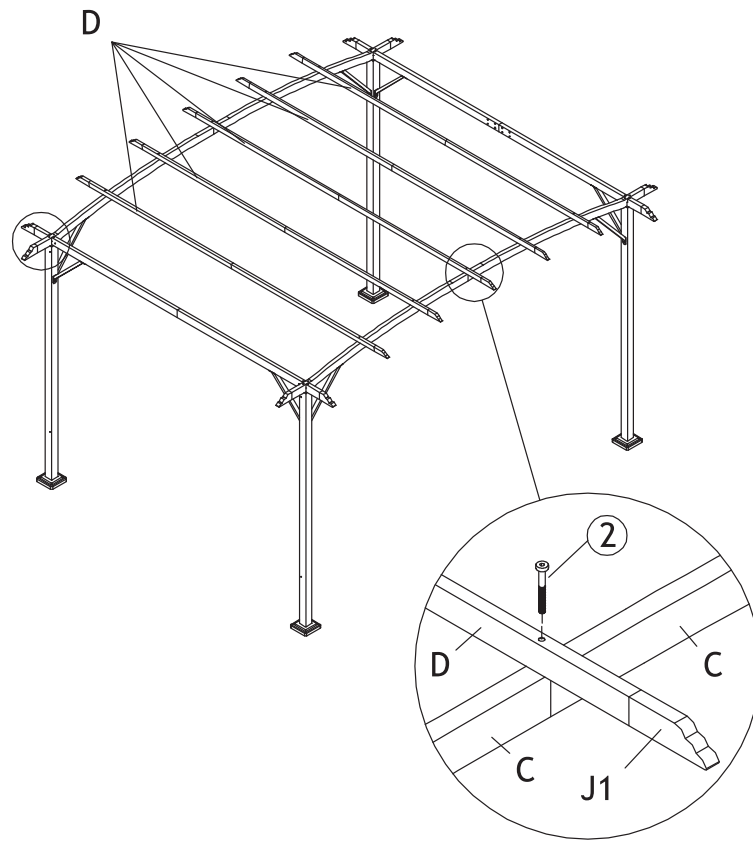

# STEP 7

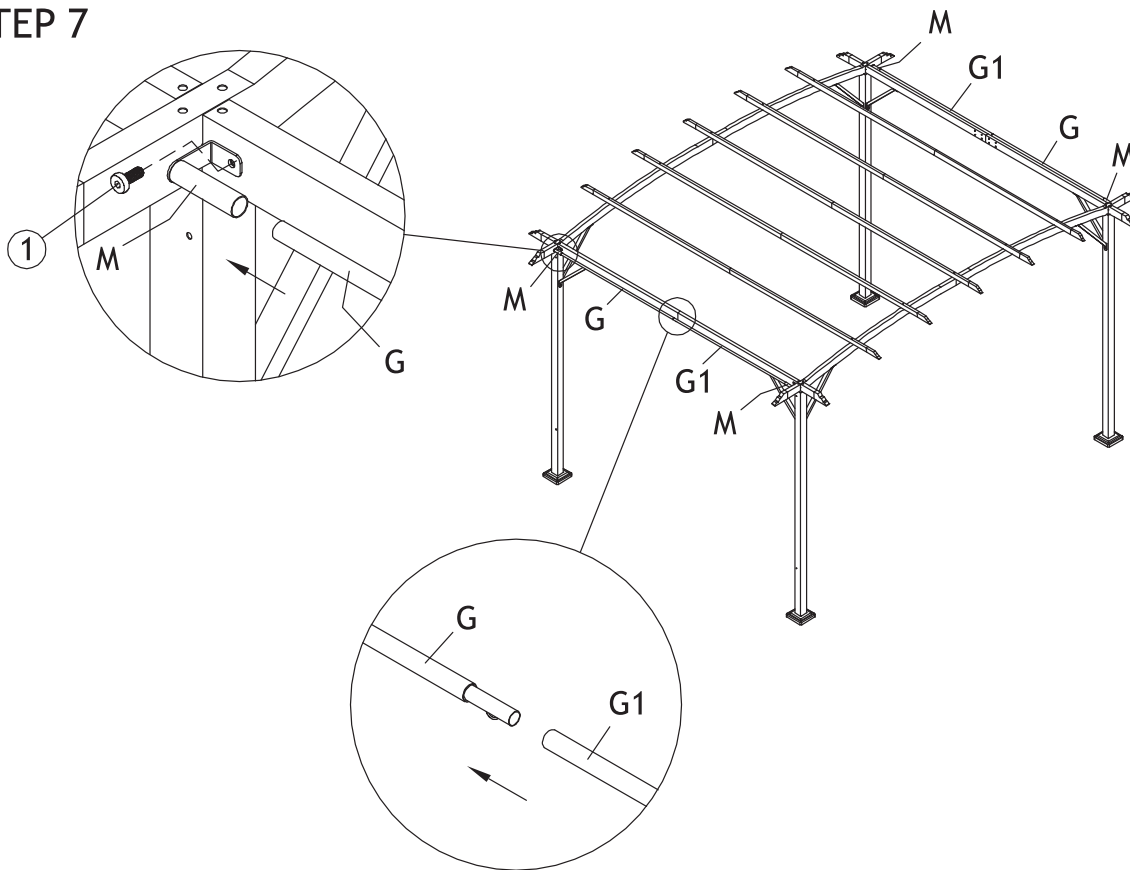

# STEP 8

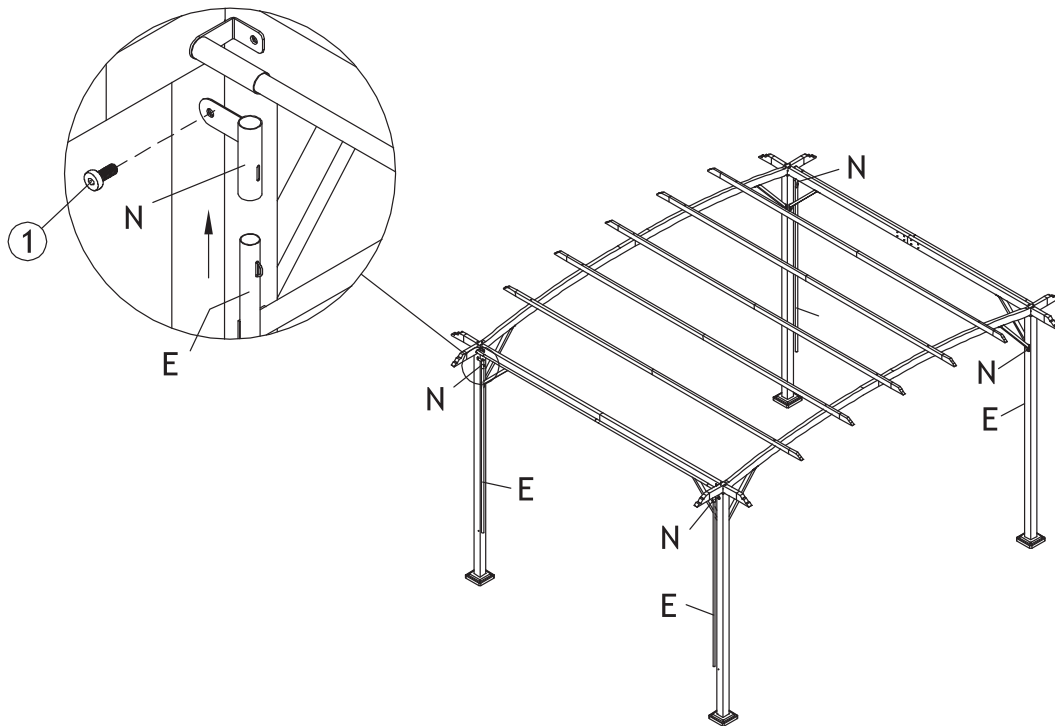

# STEP 9

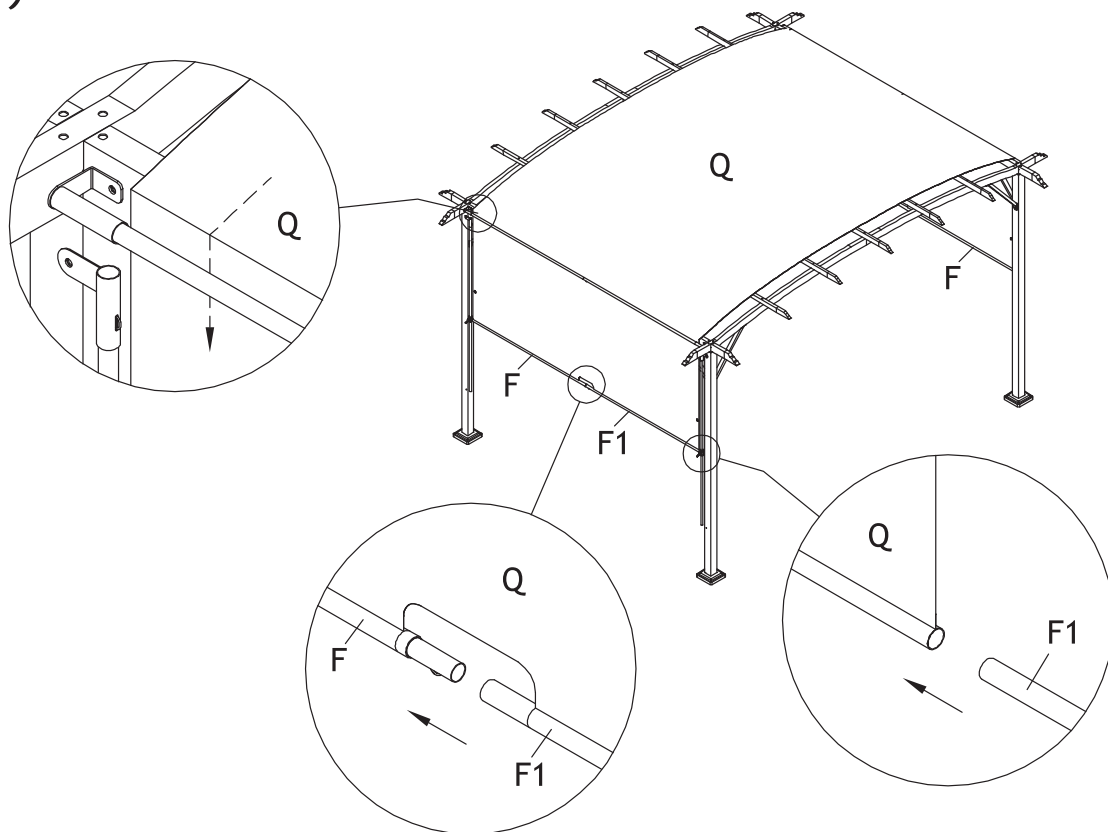



# STEP 10

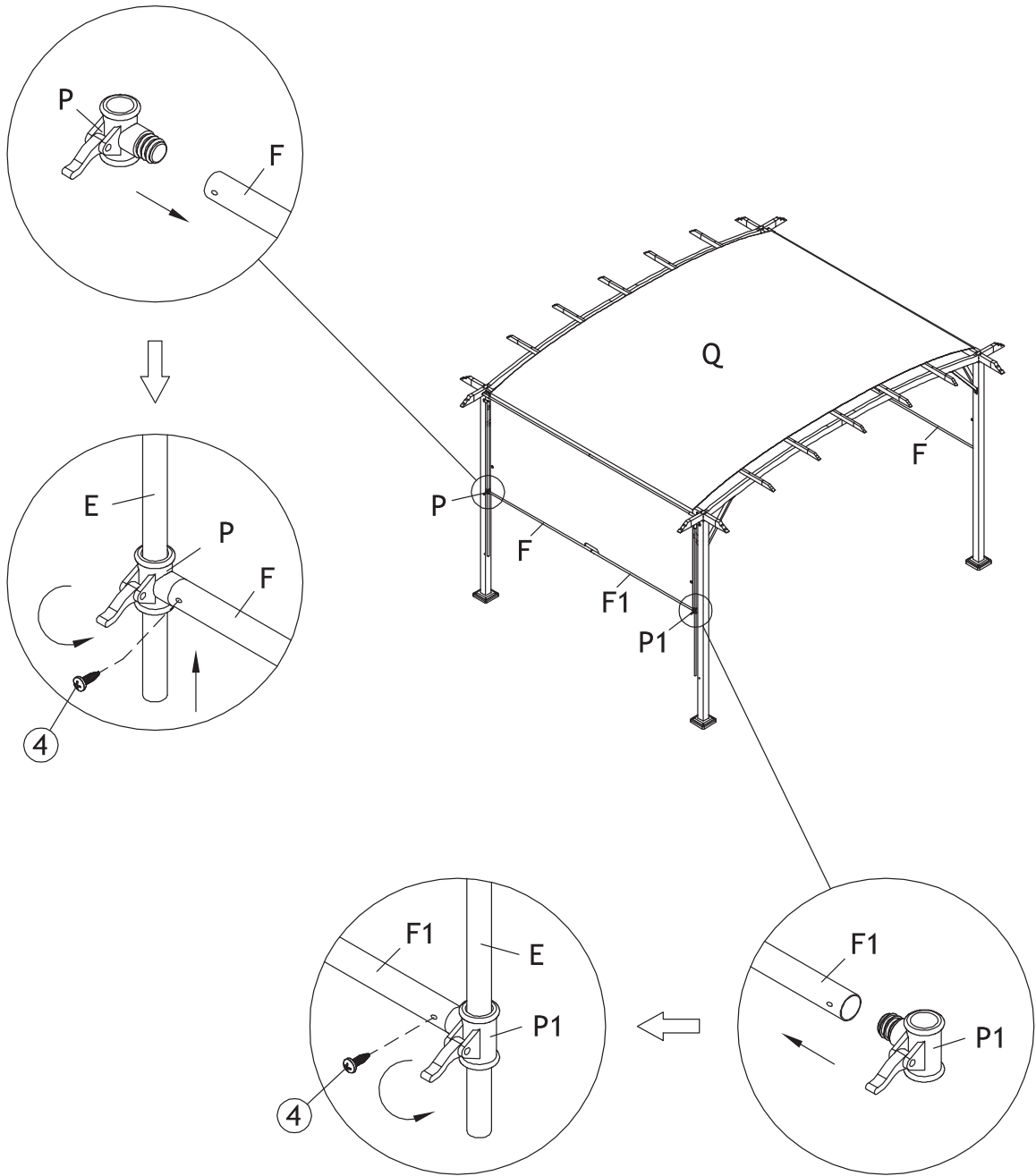

**STEP 11** Please tighten the rope of canopy in each side before using, especially before bad weather.

