

ASSEMBLY INSTRUCTION

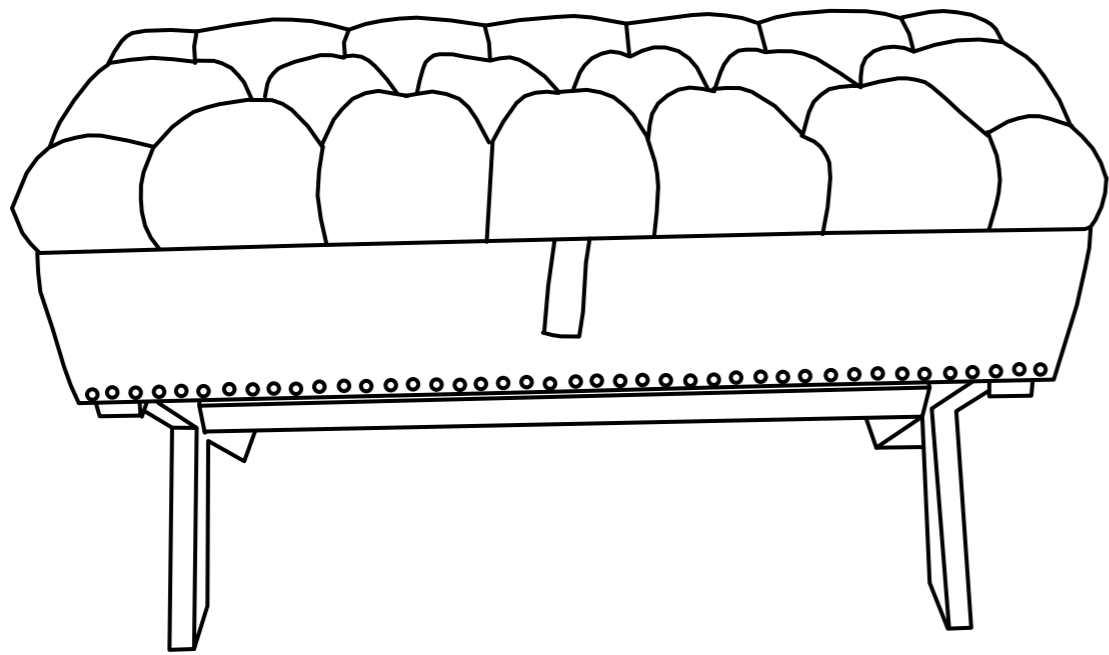
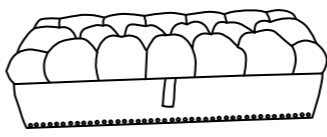
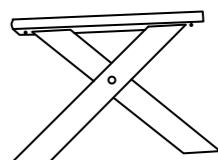
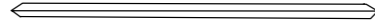
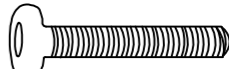
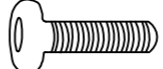
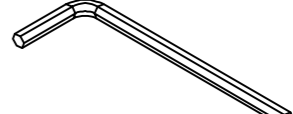

Part list

<p>A</p>  <p>X1</p>	<p>B</p>  <p>X2</p>
<p>C</p>  <p>X1</p>	<p>D</p>  <p>M6X45mm</p> <p>X4</p>
<p>E</p>  <p>M6X30mm</p> <p>X2</p>	<p>F</p>  <p>X1</p>
<p>G</p> <p>X12</p>	<p>H</p> <p>X1</p>

1

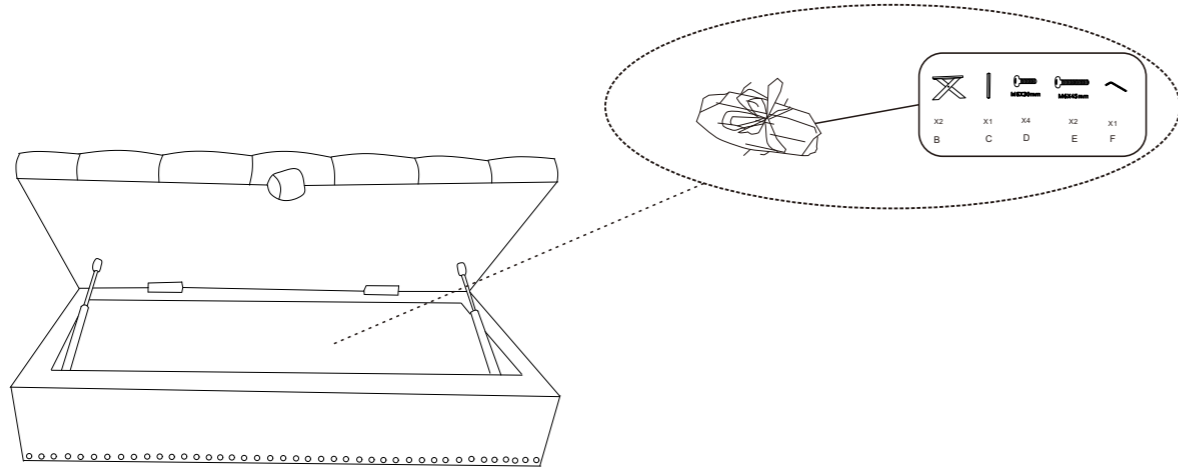

2

Use bolts (D) to secure the wooden legs (B) to the seat cushion (A).

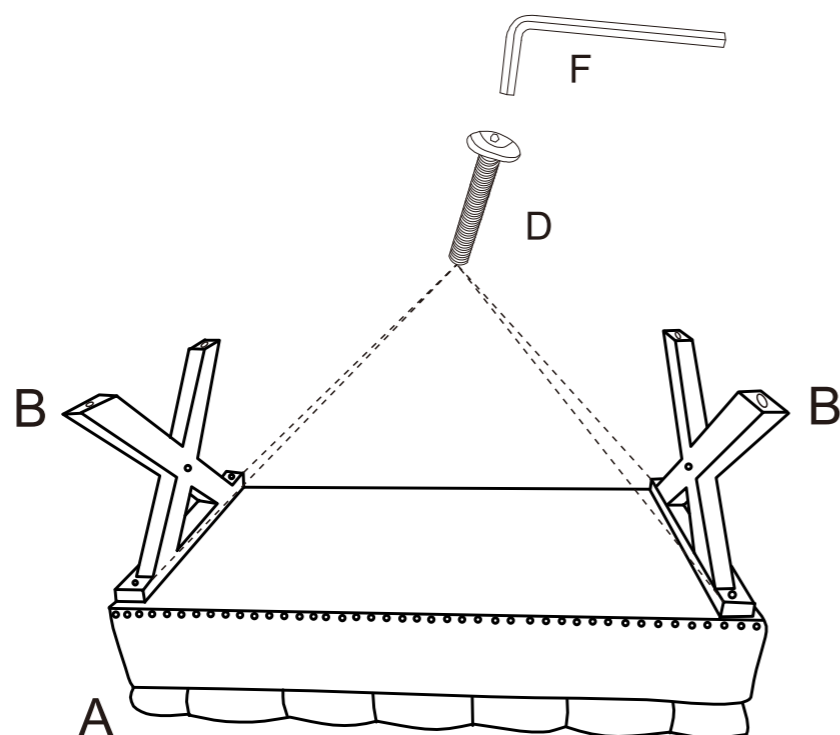

3

Use bolts (E) to fix the crossbeam (C) in the middle of the wooden leg (B).

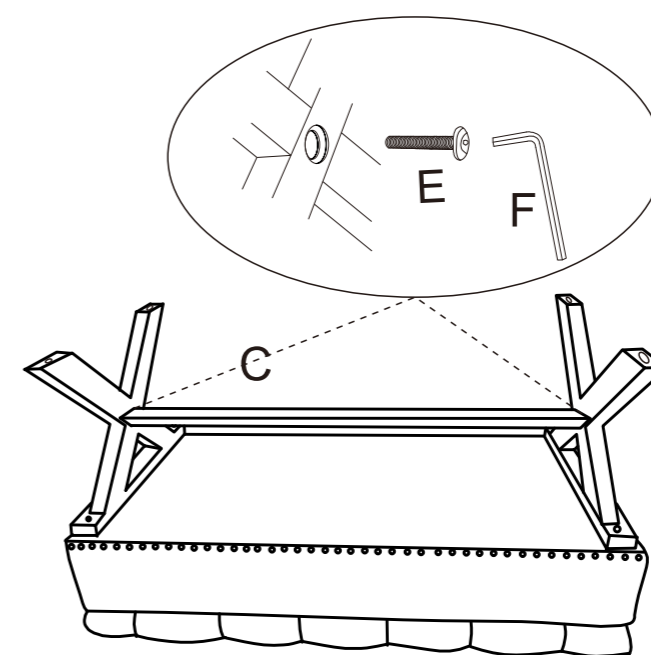

4

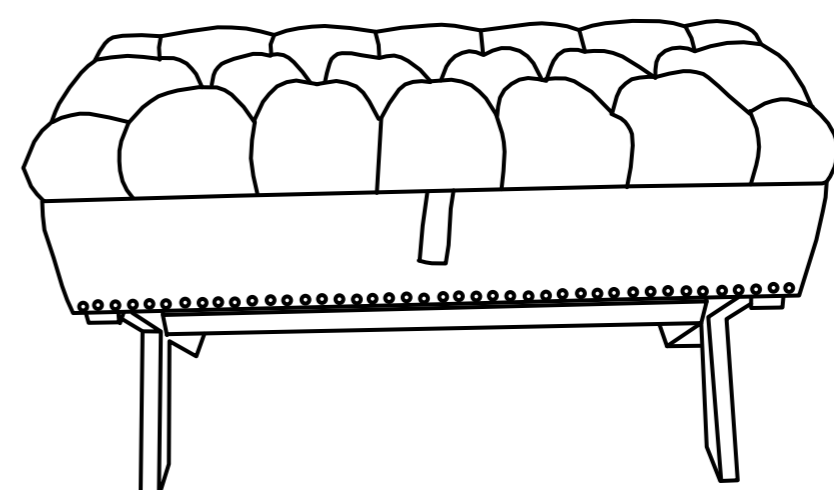

Warning:
DO NOT STAND ON THIS PRODUCT.
DO NOT USE THIS CHAIR AS A STEP LADDER.
DO NOT USE THIS PRODUCT UNLESS ALL BOLTS, SCREWS AND KNOBS ARE FIRMLY SECURED.