

BILLIARD TABLE

ASSEMBLY INSTRUCTIONS

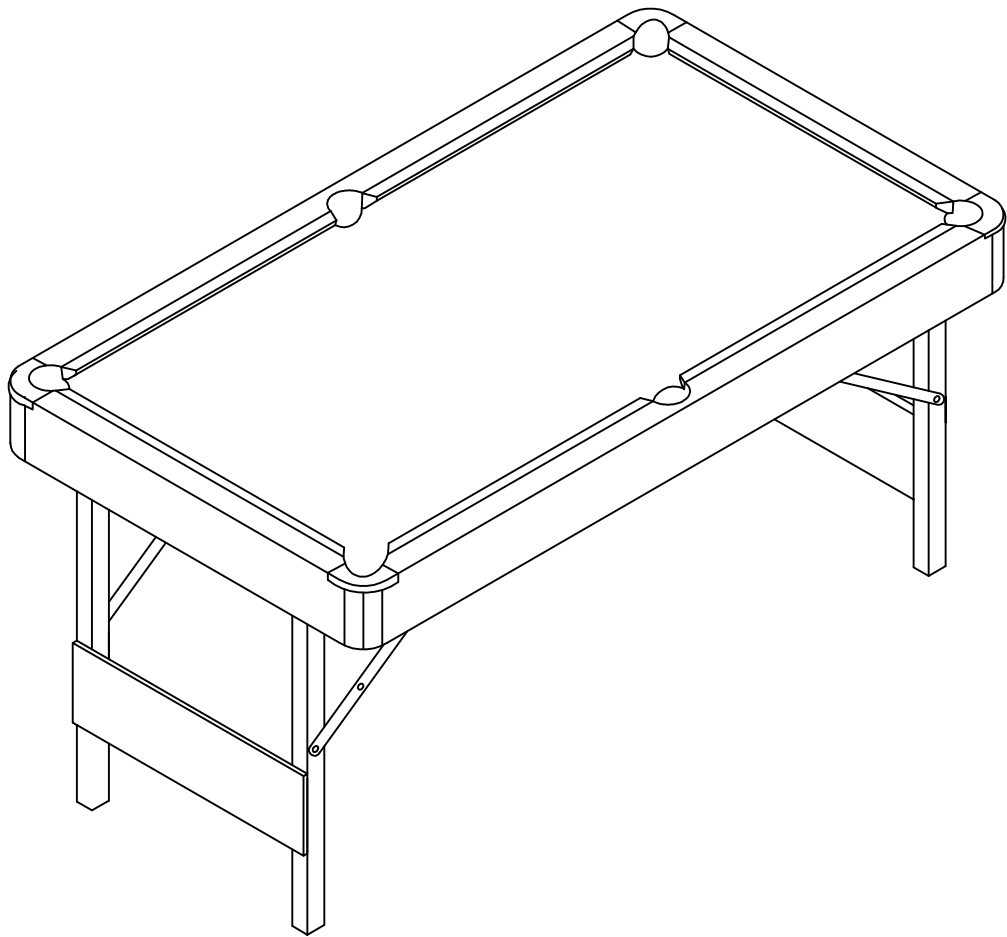



ASSEMBLY INSTRUCTIONS

BILLIARD TABLE ASSEMBLY

WARNING: TWO ADULTS NEEDED TO ASSEMBLE BILLIARD TABLE

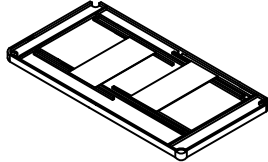
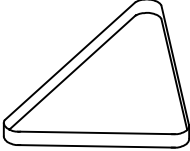
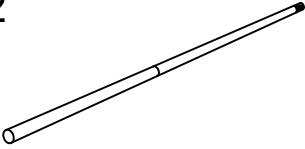
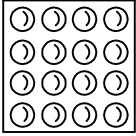
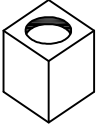
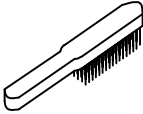
PARTS IDENTIFIER

 MAIN ASSEMBLY 1set		
A1  TRIANGLE 1pc	A2  CUE STICK 2pcs	A3  BILLIARD BALL 1set
A4  CHALK 2pcs	A5  BRUSH 1pc	A6  LEG LEVELER 4pcs

ASSEMBLY INSTRUCTIONS

BILLIARD TABLE ASSEMBLY

WARNING: TWO ADULTS NEEDED TO ASSEMBLE BILLIARD TABLE

- Step 1: Attach the leg levelers to the bottom of the legs so that the table will stay stable even when you are playing on an uneven floor.
- Step 2: Turn the Table to the correct position, and you can start enjoying the game with your family and friends.

