

BILLIARD TABLE

ASSEMBLY INSTRUCTIONS

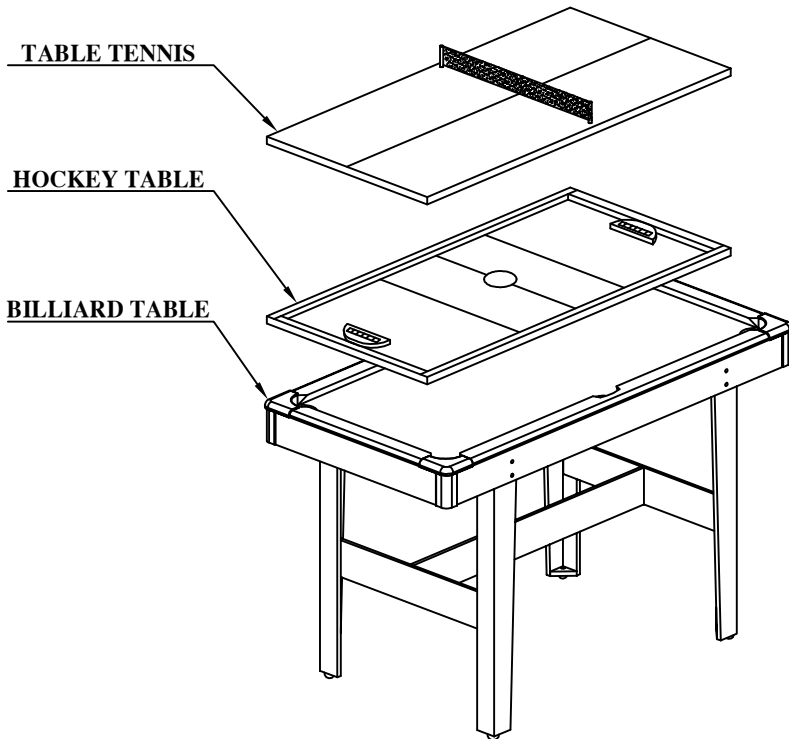









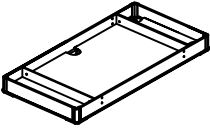
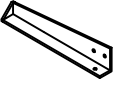
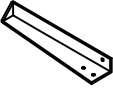
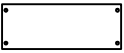
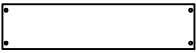

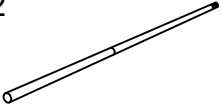
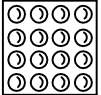
ASSEMBLY INSTRUCTIONS

BILLIARD TABLE ASSEMBLY

WARNING: TWO ADULTS NEEDED TO ASSEMBLE BILLIARD TABLE

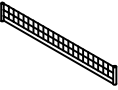
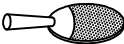
PARTS IDENTIFIER





<p>P1</p>  <p>MAIN ASSEMBLY 1set</p>	<p>P2A</p>  <p>LEG A 2pcs</p>	<p>P2B</p>  <p>LEG B 2pcs</p>
<p>P3</p>  <p>LEG END PANEL 2pcs</p>	<p>P4</p>  <p>LEG SIDE PANEL 1pc</p>	<p>P5</p>  <p>LEG LEVELER 4pcs</p>
<p>A1</p>  <p>TRIANGLE 1pc</p>	<p>A2</p>  <p>CUE STICK 2pcs</p>	<p>A3</p>  <p>BILLIARD BALL 1set</p>
<p>A4</p>  <p>CHALK 2pcs</p>	<p>A5</p>  <p>BRUSH 1pc</p>	<p>A6</p>  <p>HOCKEY TABLE 1 pc</p>
<p>A7</p>  <p>HOCKEY STRIKER 2 pcs</p>	<p>A8</p>  <p>HOCKEY PUNK 4 pcs</p>	<p>A9</p>  <p>TABLE TENNIS NET 1 pc</p>
<p>A10</p>  <p>TABLE TENNIS PADDLE 2 pcs</p>	<p>A11</p>  <p>TABLE TENNIS BALL 2 pcs</p>	<p>A12</p>  <p>ALLEN WRENCH 1 pc</p>

ASSEMBLY INSTRUCTIONS

BILLIARD TABLE ASSEMBLY

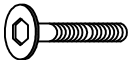
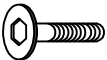
WARNING: TWO ADULTS NEEDED TO ASSEMBLE BILLIARD TABLE

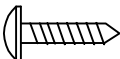
HARDWARE

<p>H1</p>  <p>BOLT $\frac{1}{4}$x1-1/8 12 pcs</p>	<p>H2</p>  <p>BOLT $\frac{1}{4}$x1" 8 pcs</p>	<p>H3</p>  <p>WASHER 20 pcs</p>
<p>H4</p>  <p>SCREW 4 pcs</p>	<p>H5</p>  <p>CYLINDRICAL NUT 4 pcs</p>	

ASSEMBLY INSTRUCTIONS

BILLIARD TABLE ASSEMBLY

WARNING: TWO ADULTS NEEDED TO ASSEMBLE BILLIARD TABLE

1. ASSEMBLE EACH LEG **P2A&P2B** BY USING THREE BOLTS **H1**, WITH THREE FLAT BLACK WASHERS **H3**.
2. INSERT THE NUT **H5** INTO THE HOLE OF THE SINDE PANEL **P4**. THE HOLE OF THE NUT ALIGN THE HOLE OF THE PANELS.
3. ATTACH THE LEG END PANELS **P3** WITH **H2&H3**. ATTACH THE LEG SINE PANELS **P4** WITH CREWS **H4**.
4. SCREW LEG LEVELERS **P5** INTO BOTTOM OF LEGS.

