

ASSEMBLY INSTRUCTION

SKU CODE: (WF325836AAK/WF325836AAB)

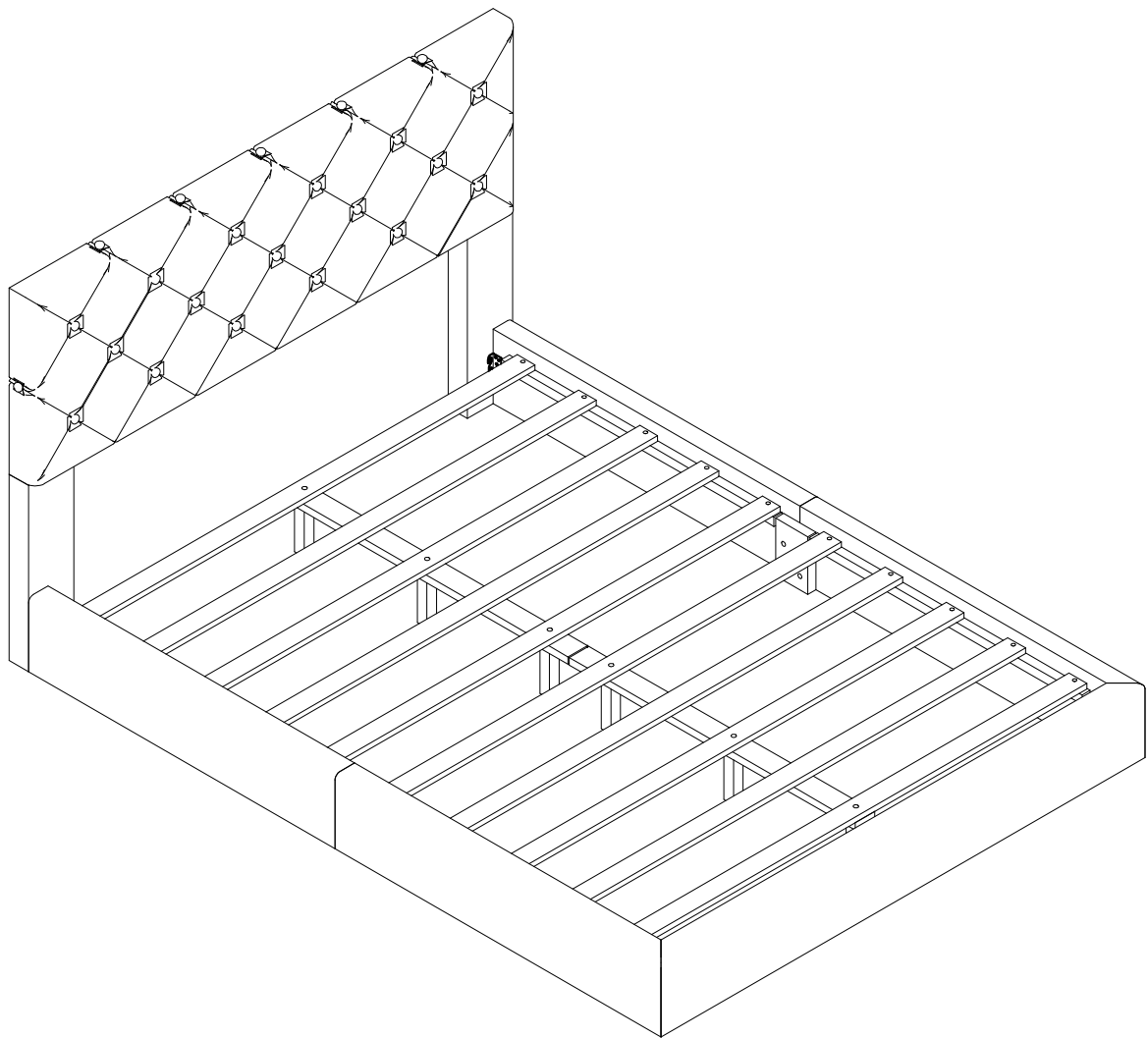

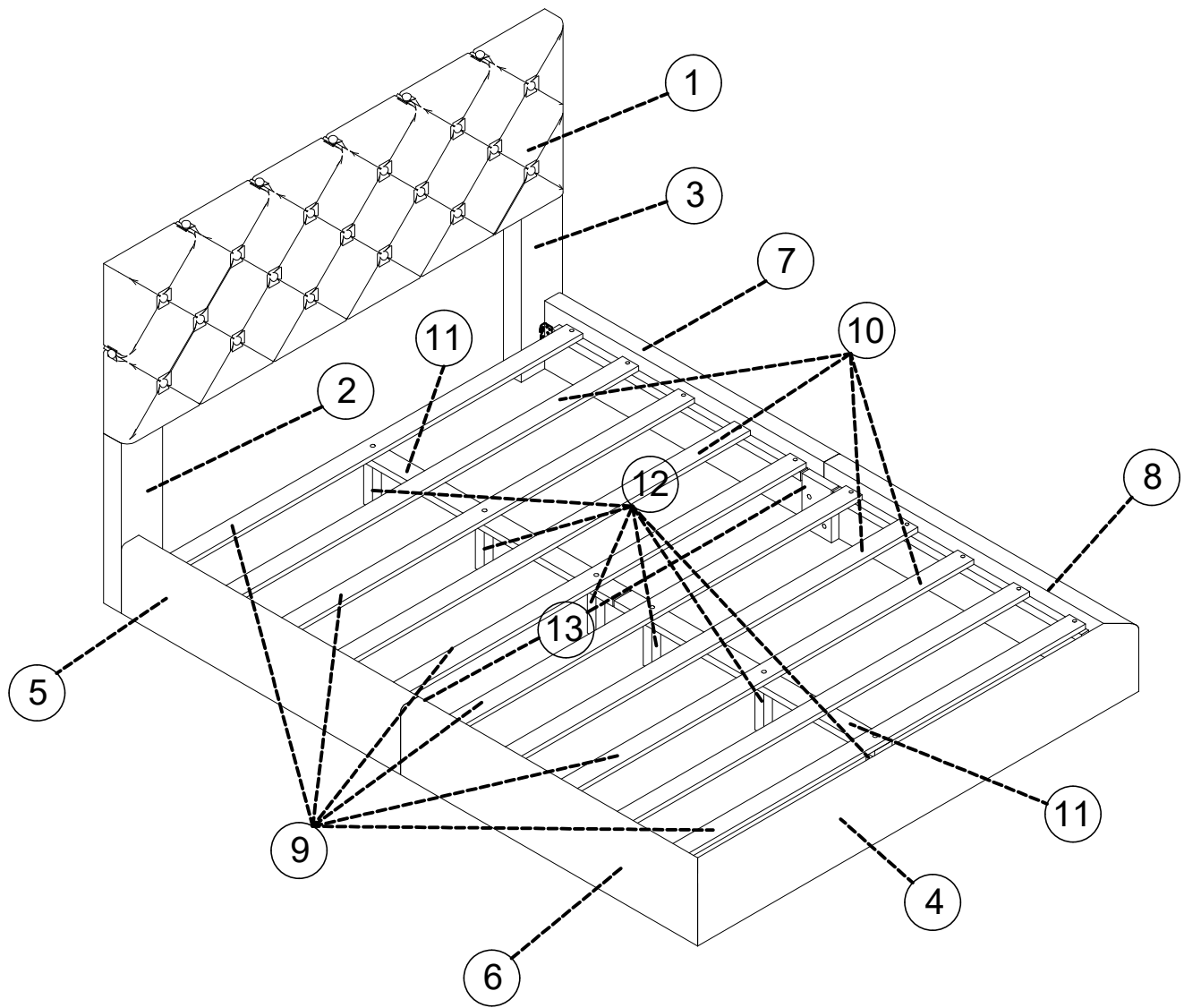



**This set included 1 boxex if do not receive full 1
boxex. Please contact our customer service team**



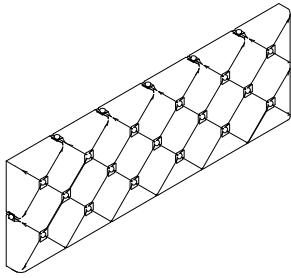

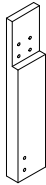
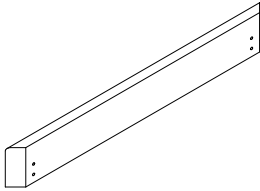
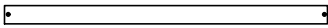
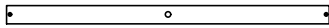
Part List

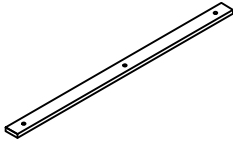
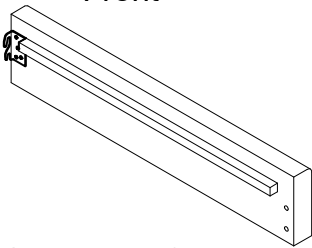
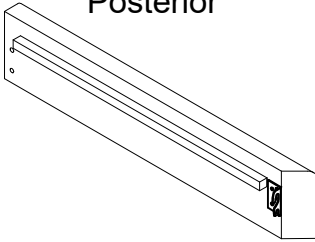
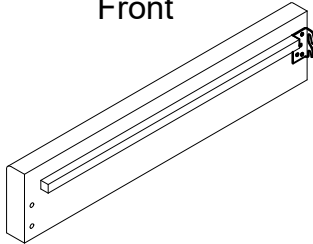
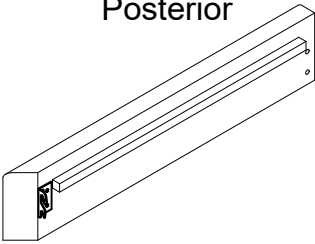





BOX 1/1: WF325836AAK/WF325836AAB

<p>1</p>  <p>Head board -1pc</p>	<p>2</p>  <p>Head board legs Left-1pc</p>	<p>3</p>  <p>Head board legs Right-1pc</p>
<p>4</p>  <p>Footboard-1pc</p>	<p>10</p>  <p>Slates-4pcs</p>	<p>9</p>  <p>Slates-6pcs</p>
<p>12</p>  <p>Legs middle-6pcs</p>	<p>12</p>  <p>Bed side leg-2pcs</p>	<p>11</p>  <p>Bed support Slates-2pcs</p>
<p>7</p> <p>Front</p>  <p>Side rail Left - 1pc</p>	<p>8</p> <p>Posterior</p>  <p>Side rail Left - 1pc</p>	<p>5</p> <p>Front</p>  <p>Side rail Right - 1pc</p>
<p>6</p> <p>Posterior</p>  <p>Side rail Right - 1pc</p>	<p>Hardware</p> 	

HARDWARE

Check that you've received
all hardware listed below.

Hardware List

No.	OUTLOOK	DESC	QTY
(A)		Bolts 5/16"x30 mm	16
(B)		Plain washer Ø5/16"x19x1.5 mm	30
(C)		Spring washer Ø5/16"x12 mm	30
(D)		Allen key 80x30x4 mm	1
(E)		Bolts 5/16"x45 mm	14
(F)		Screws Ø4x30 mm	20



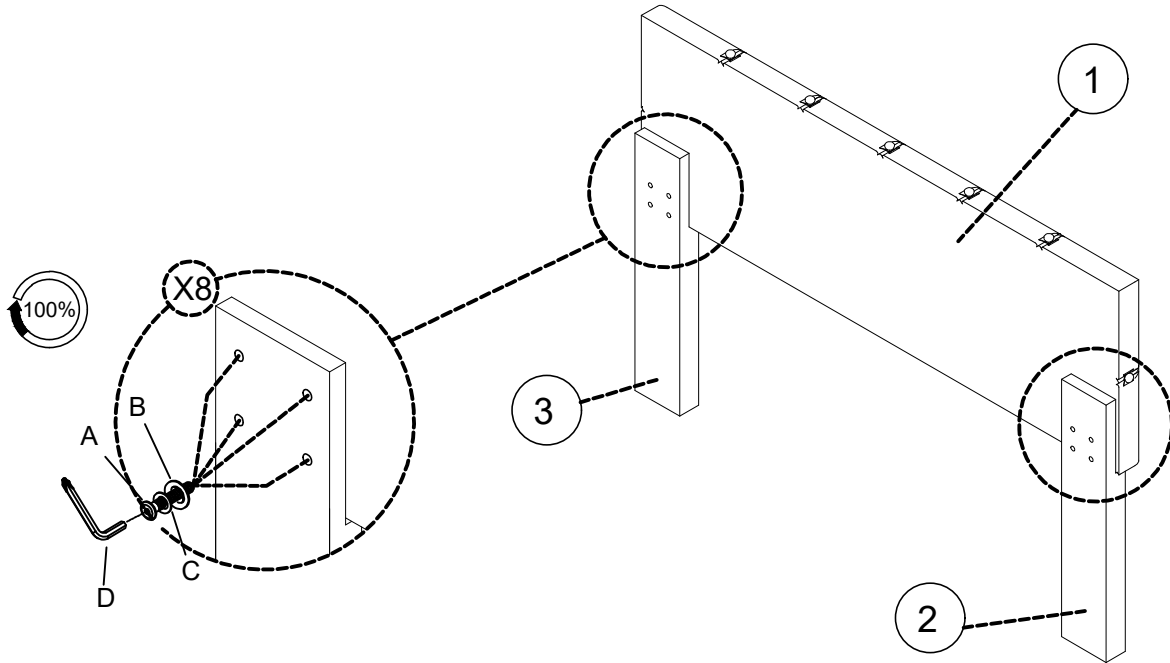
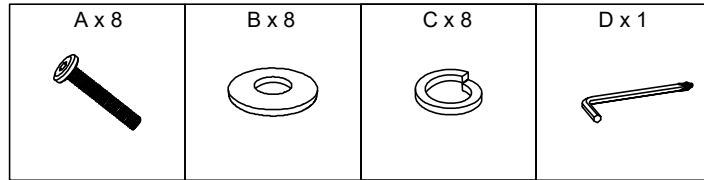

STEP 1

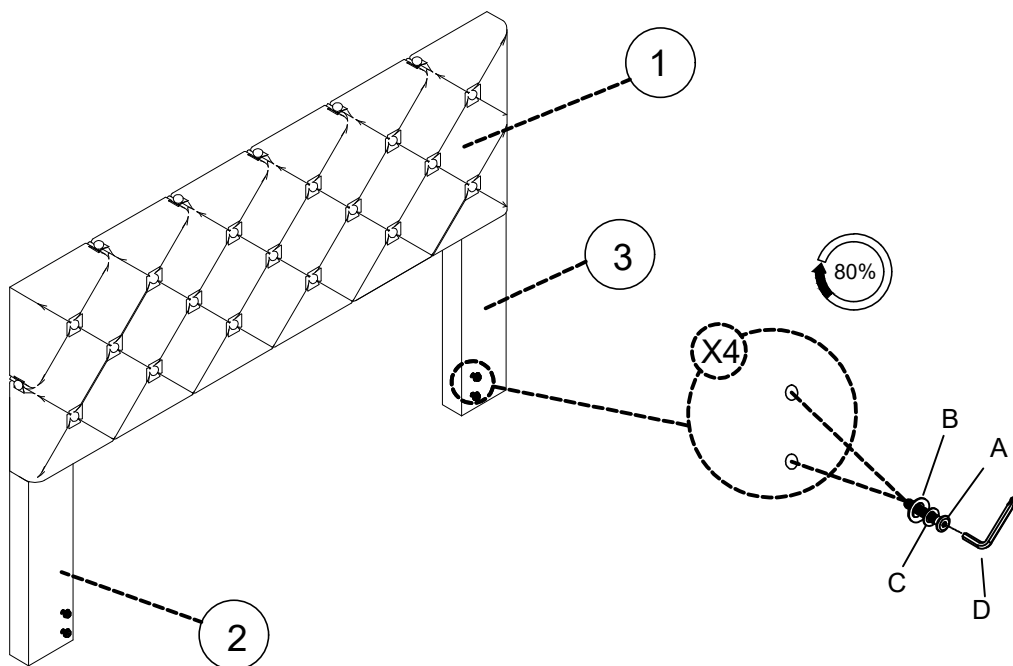
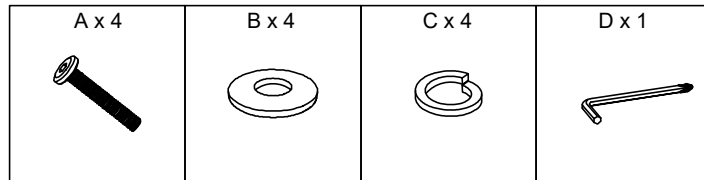

STEP 2





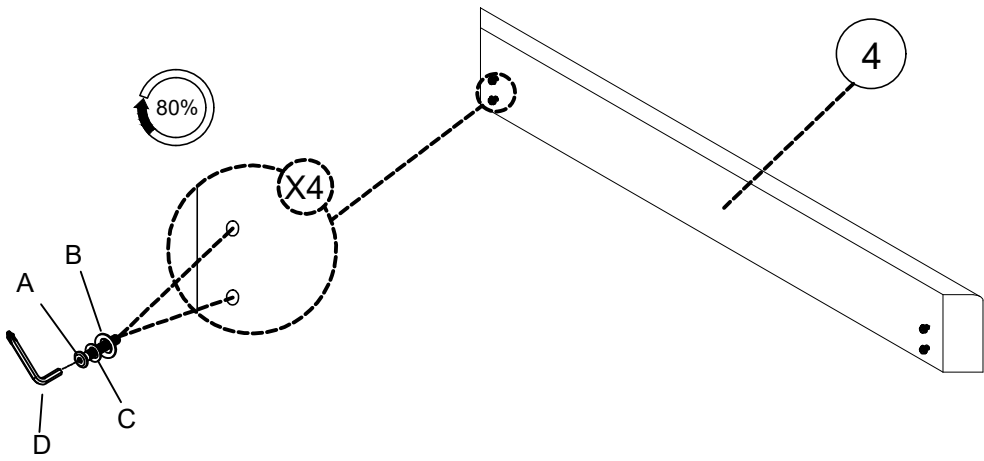

STEP 3

A x 4	B x 4	C x 4	D x 1
			



STEP 4

E x 4	B x 4	C x 4	D x 1
			

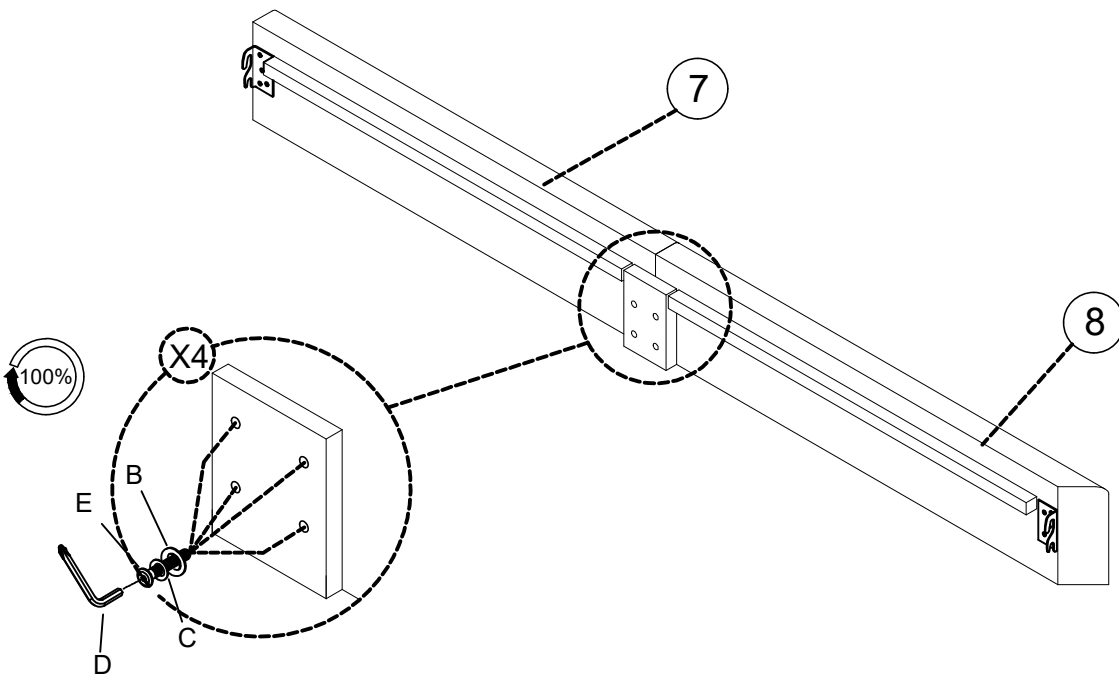

STEP 5

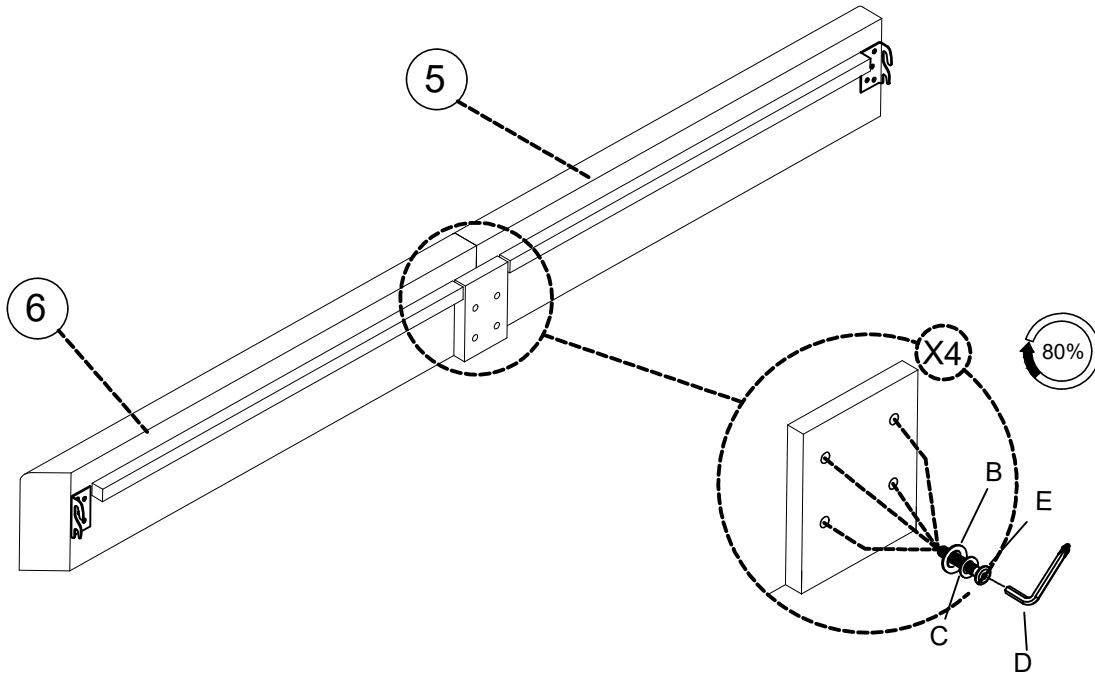
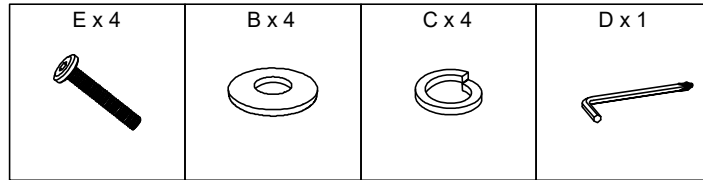

STEP 6

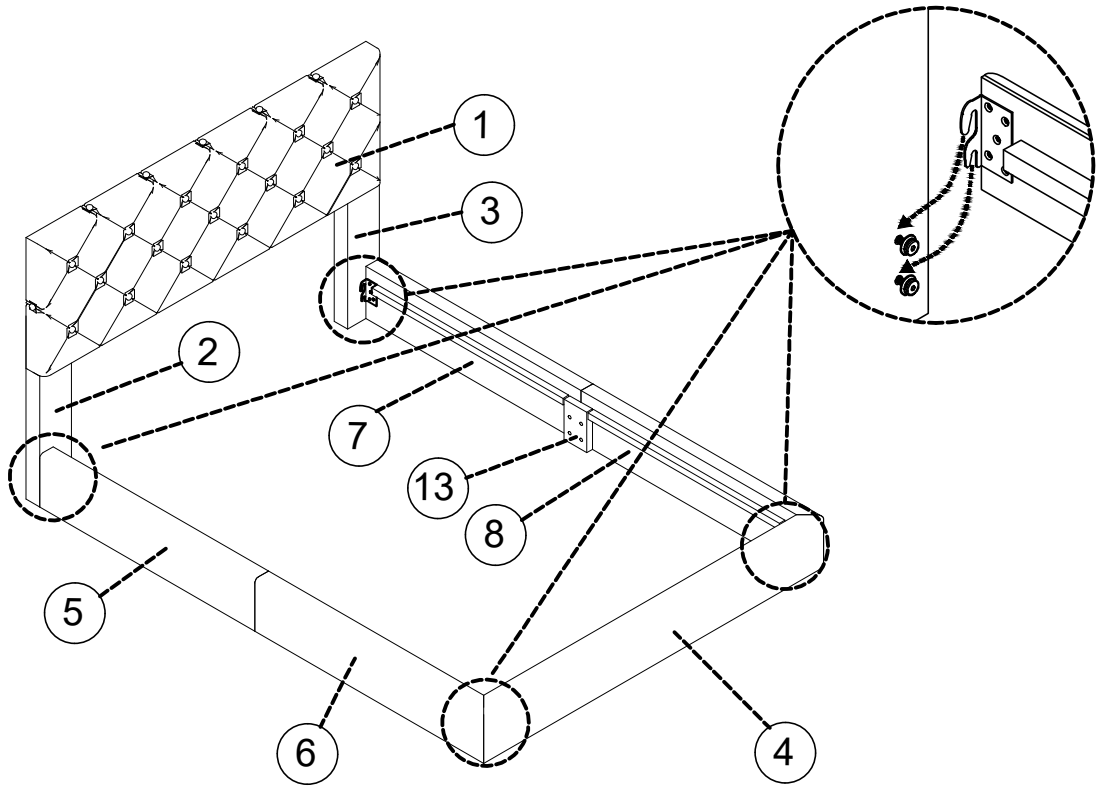

STEP 7

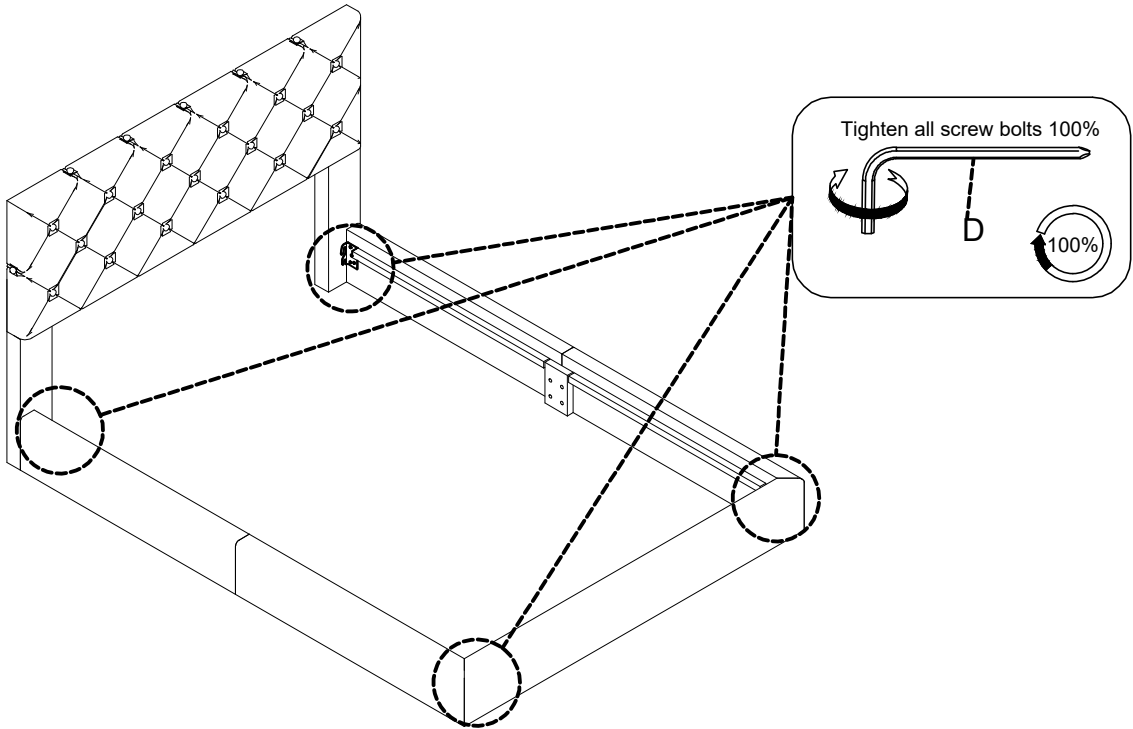

STEP 8

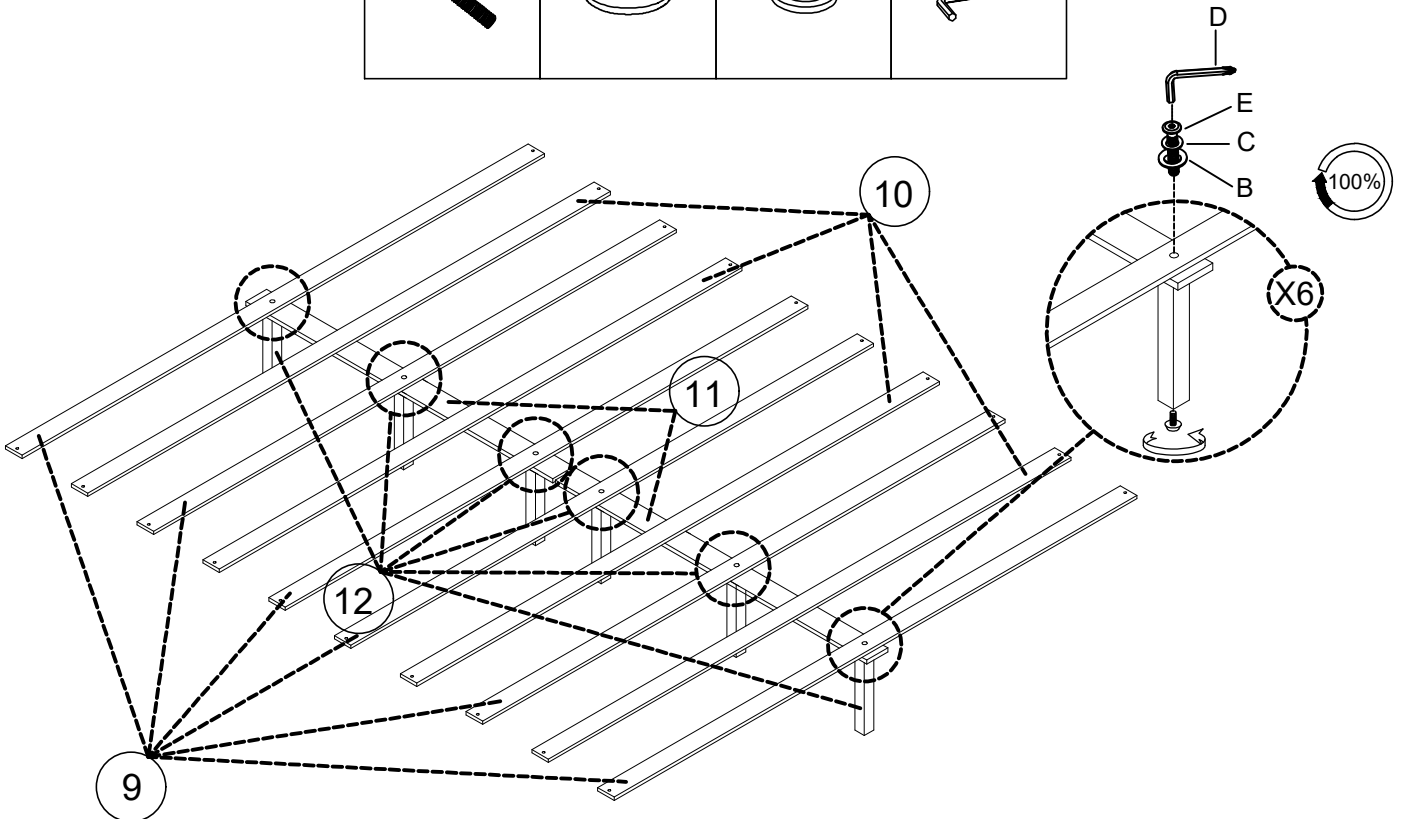
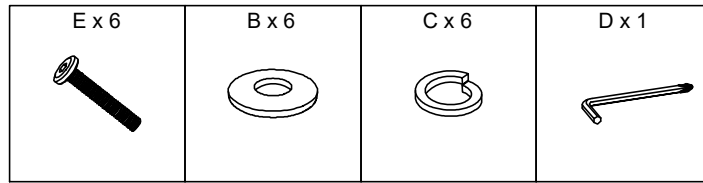

STEP 9

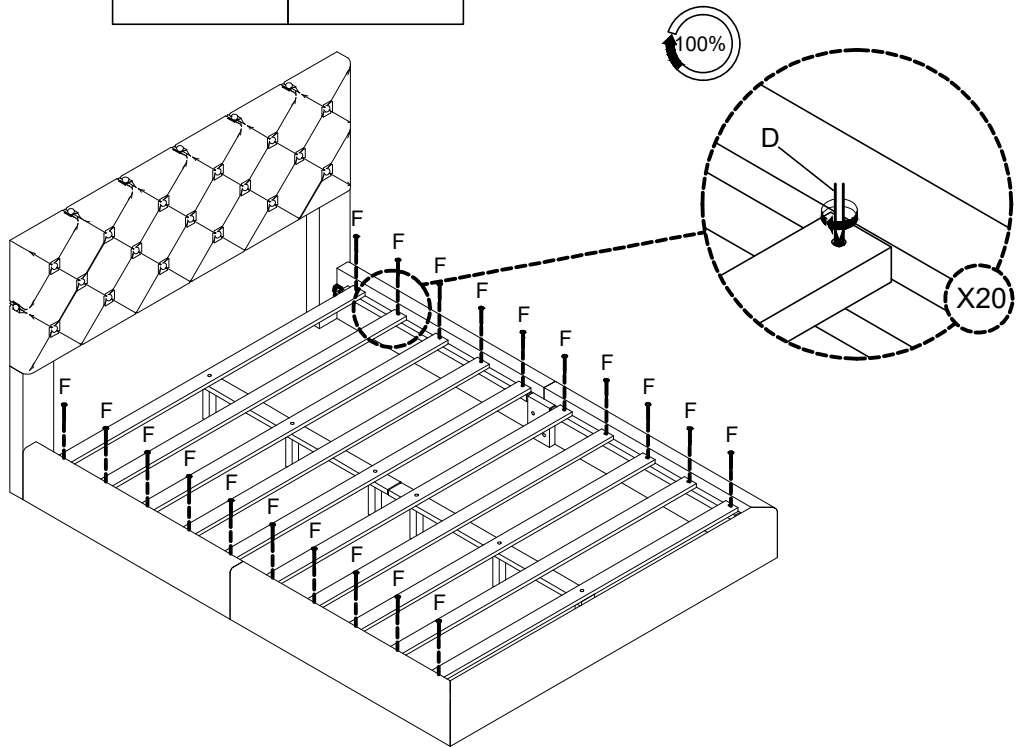
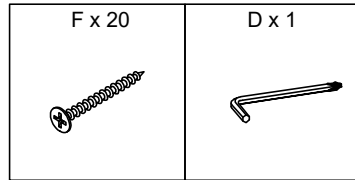

COMPLETE

