

ASSEMBLY INSTRUCTION

SKU CODE: (WF325836AAK/WF325836AAB)

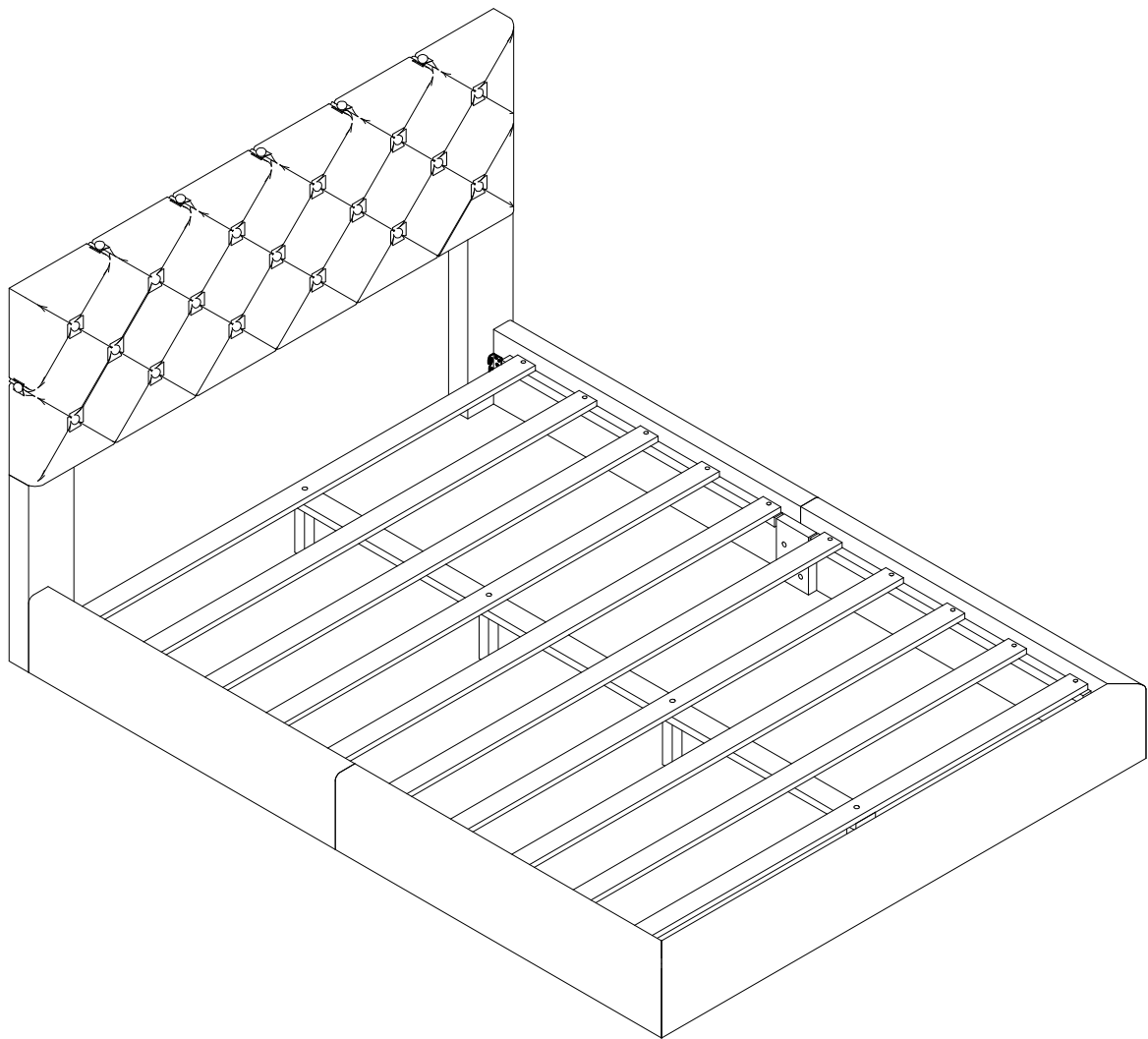

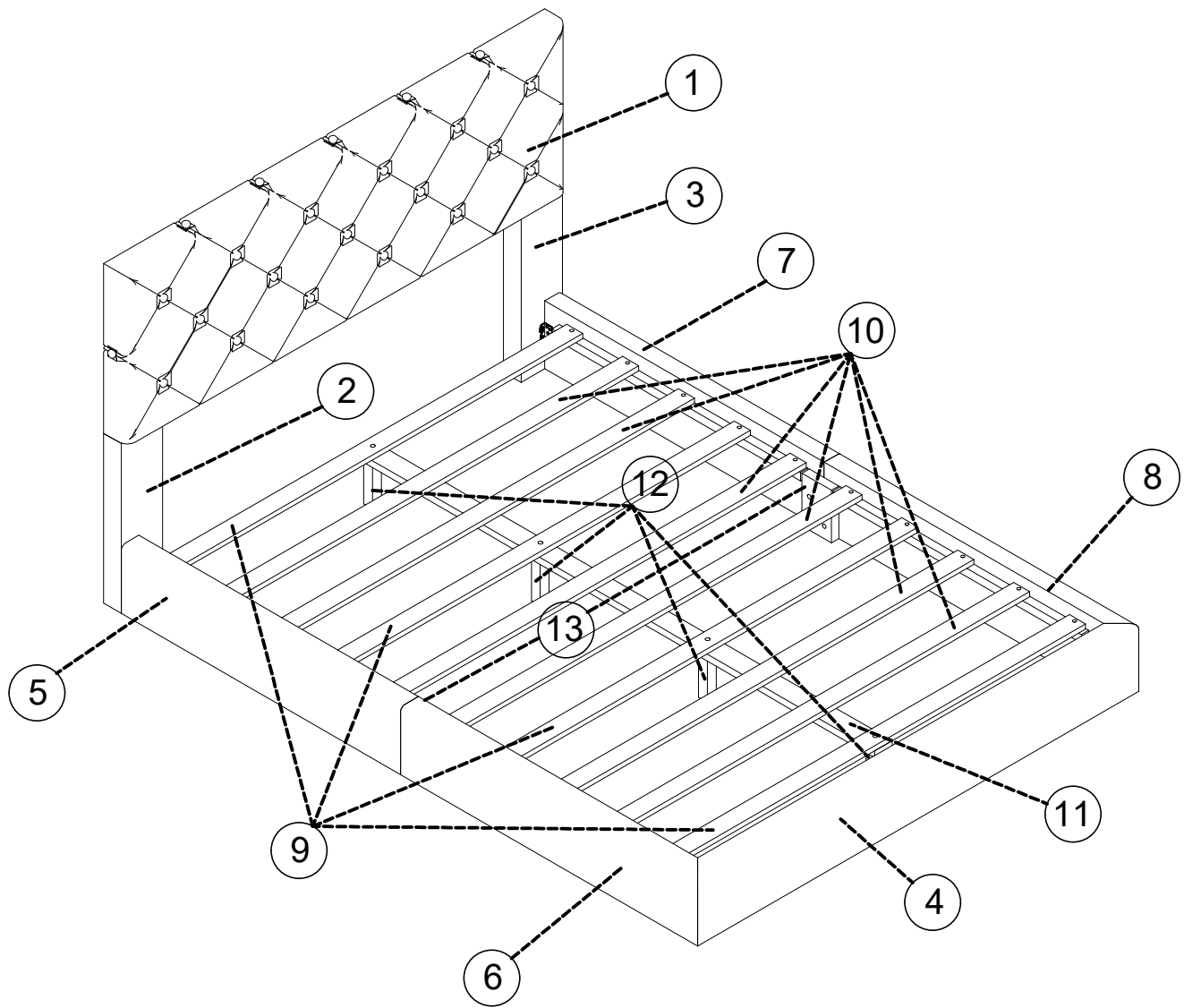



This set included 1 boxex if do not receive full 1 boxex. Please contact our customer service team



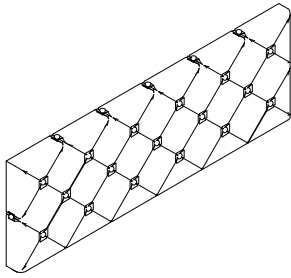

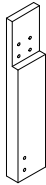
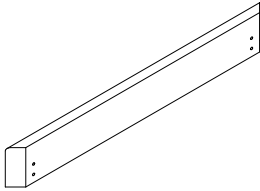
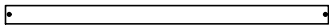
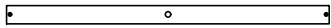
Part List

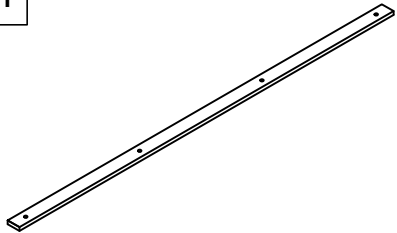
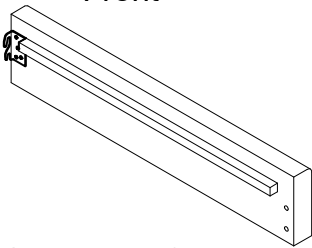
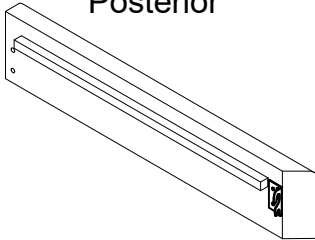
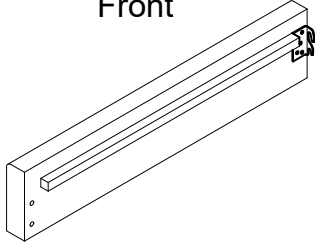
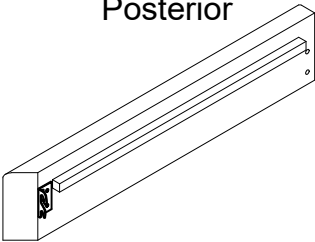





BOX 1/1: WF325836AAK/WF325836AAB

<p>1</p>  <p>Head board -1pc</p>	<p>2</p>  <p>Head board legs Left-1pc</p>	<p>3</p>  <p>Head board legs Right-1pc</p>
<p>4</p>  <p>Footboard-1pc</p>	<p>10</p>  <p>Slates-6pcs</p>	<p>9</p>  <p>Slates-4pcs</p>
<p>12</p>  <p>Legs middle-4pcs</p>	<p>13</p>  <p>Bed side leg-2pcs</p>	<p>11</p>  <p>Bed support Slates-1pc</p>
<p>7</p> <p>Front</p>  <p>Side rail Left - 1pc</p>	<p>8</p> <p>Posterior</p>  <p>Side rail Left - 1pc</p>	<p>5</p> <p>Front</p>  <p>Side rail Right - 1pc</p>
<p>6</p> <p>Posterior</p>  <p>Side rail Right - 1pc</p>	<p>Hardware</p> 	





HARDWARE

Check that you've received
all hardware listed below.

Hardware List



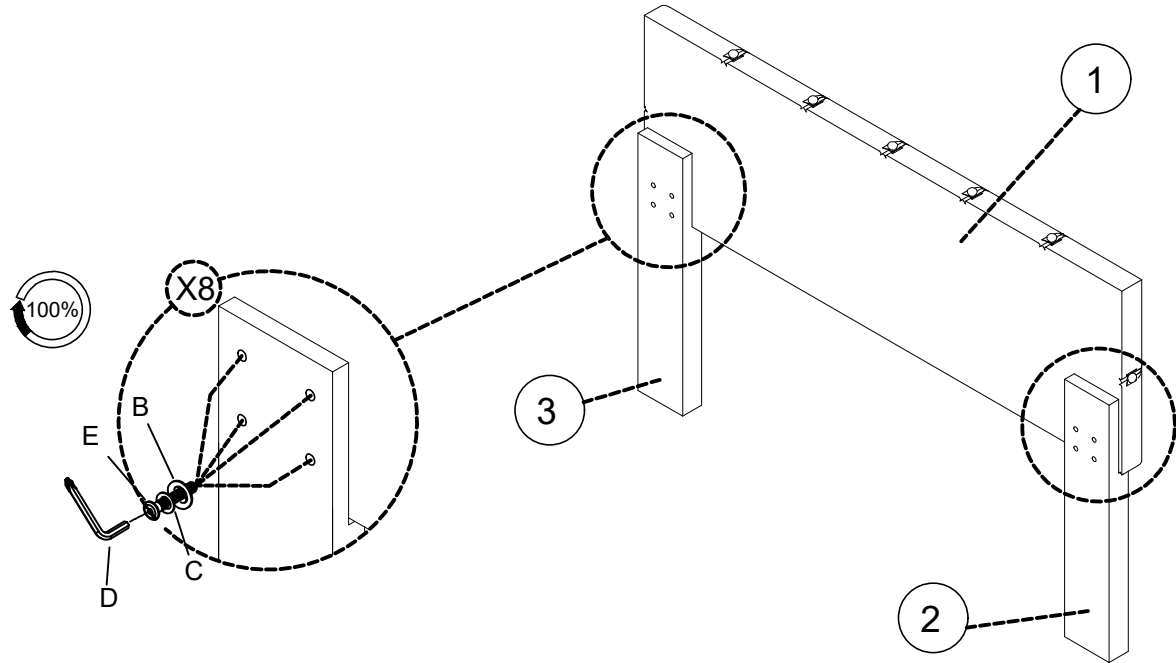

No.	OUTLOOK	DESC	QTY
(A)		Bolts 5/16"x30 mm	8
(B)		Plain washer Ø5/16"x19x1.5 mm	28
(C)		Spring washer Ø5/16"x12 mm	28
(D)		Allen key 80x30x4 mm	1
(E)		Bolts 5/16"x45 mm	20
(F)		Screws Ø4x30 mm	20

STEP 1

E x 8	B x 8	C x 8	D x 1
			



STEP 2

A x 4	B x 4	C x 4	D x 1
			

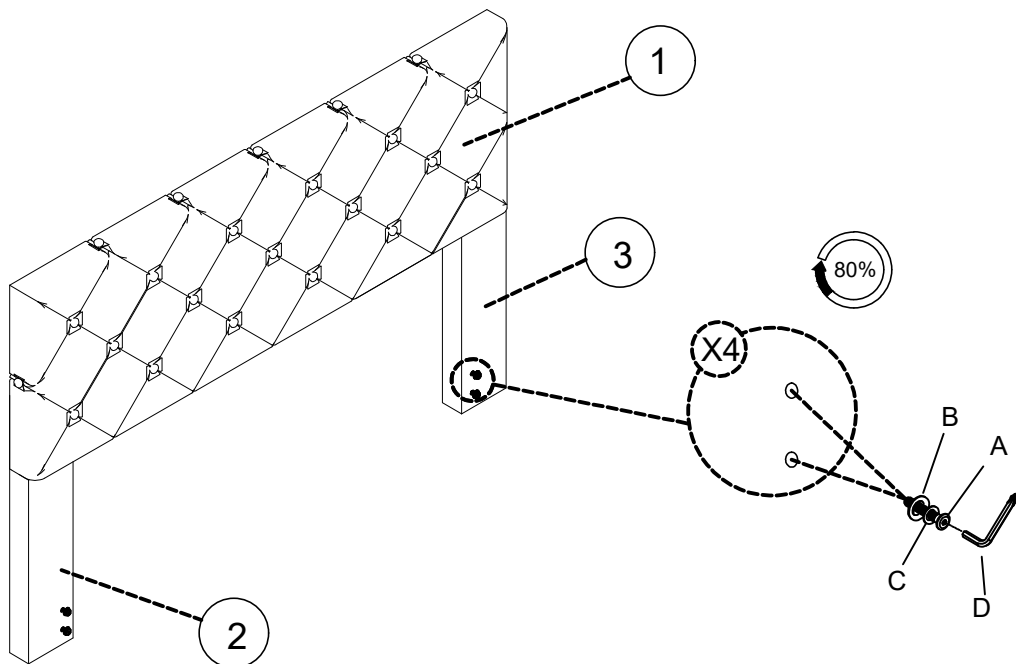

STEP 3

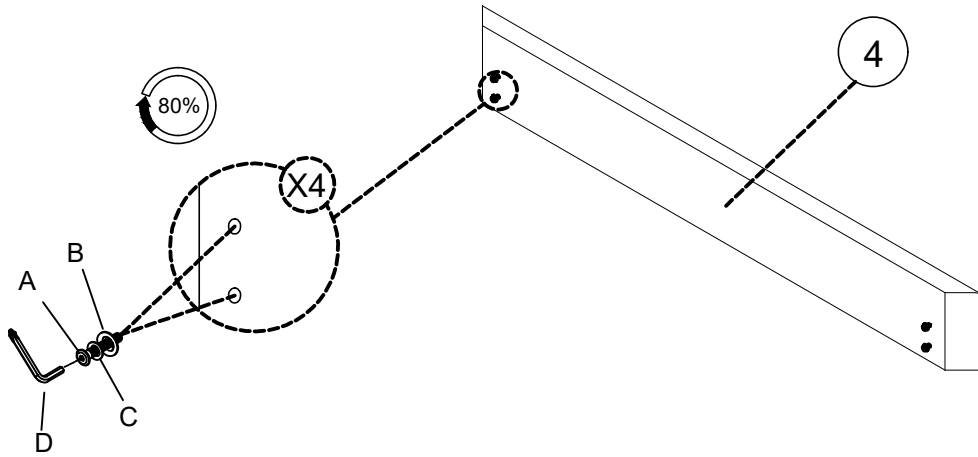
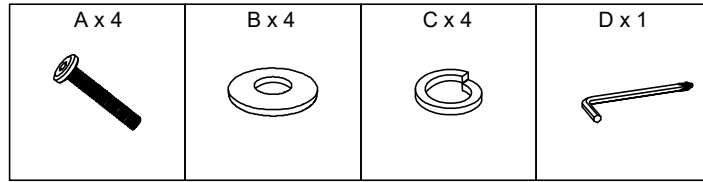

STEP 4

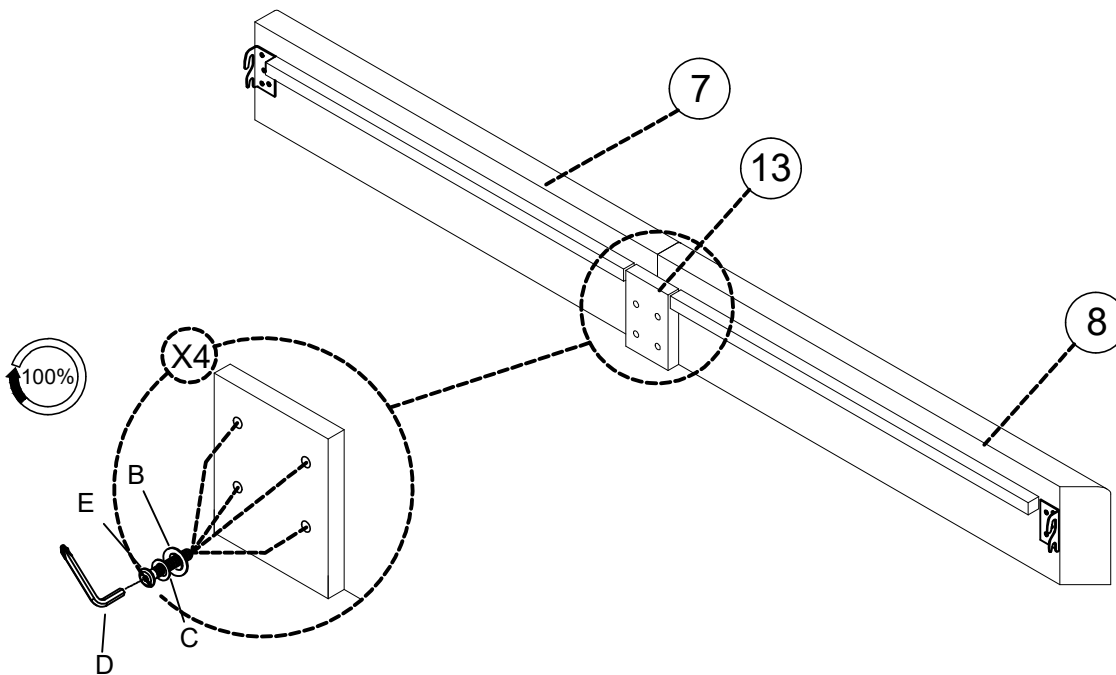
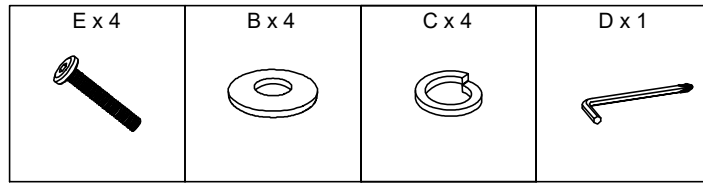

STEP 5

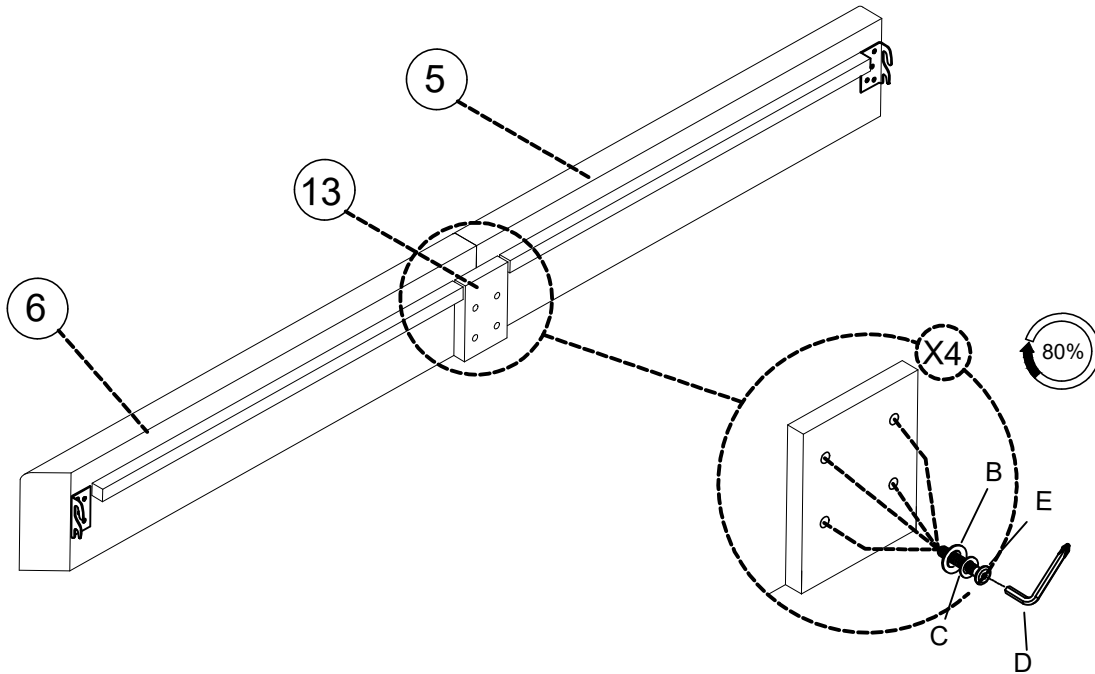
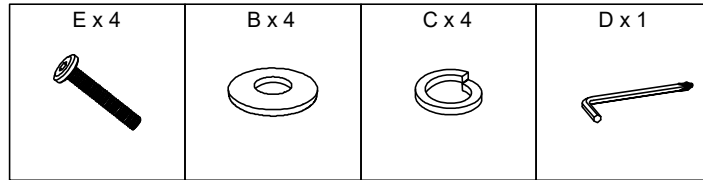

STEP 6

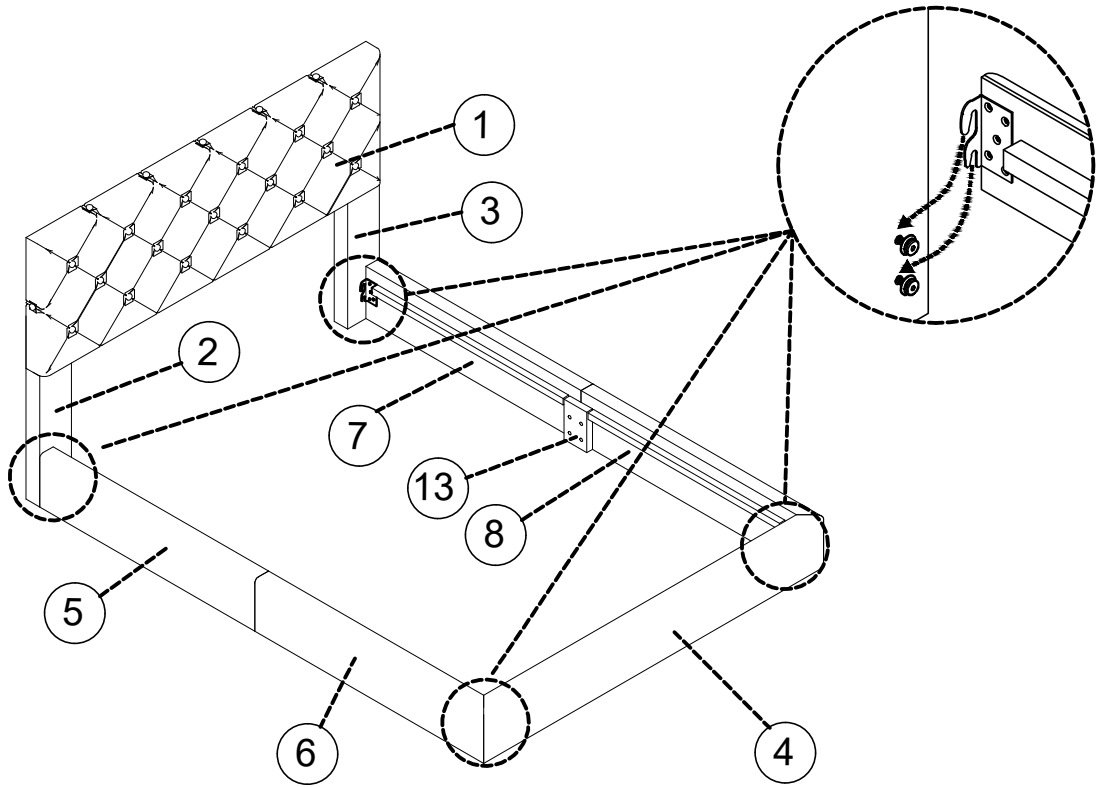

STEP 7

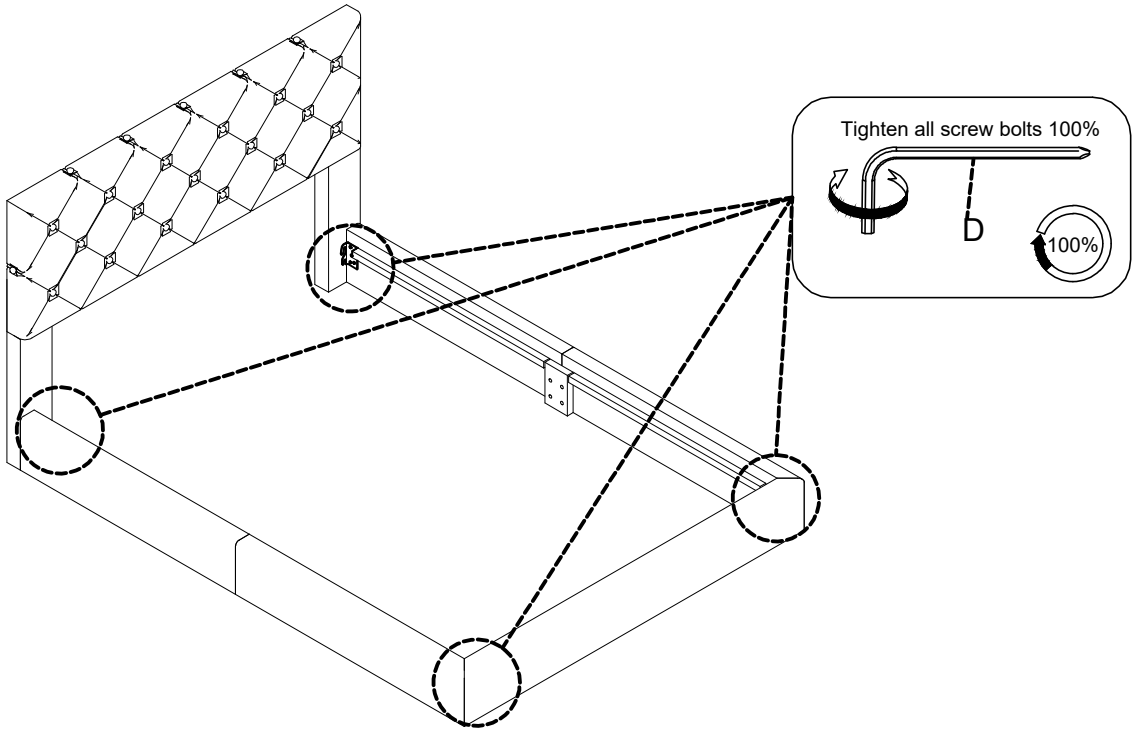

STEP 8

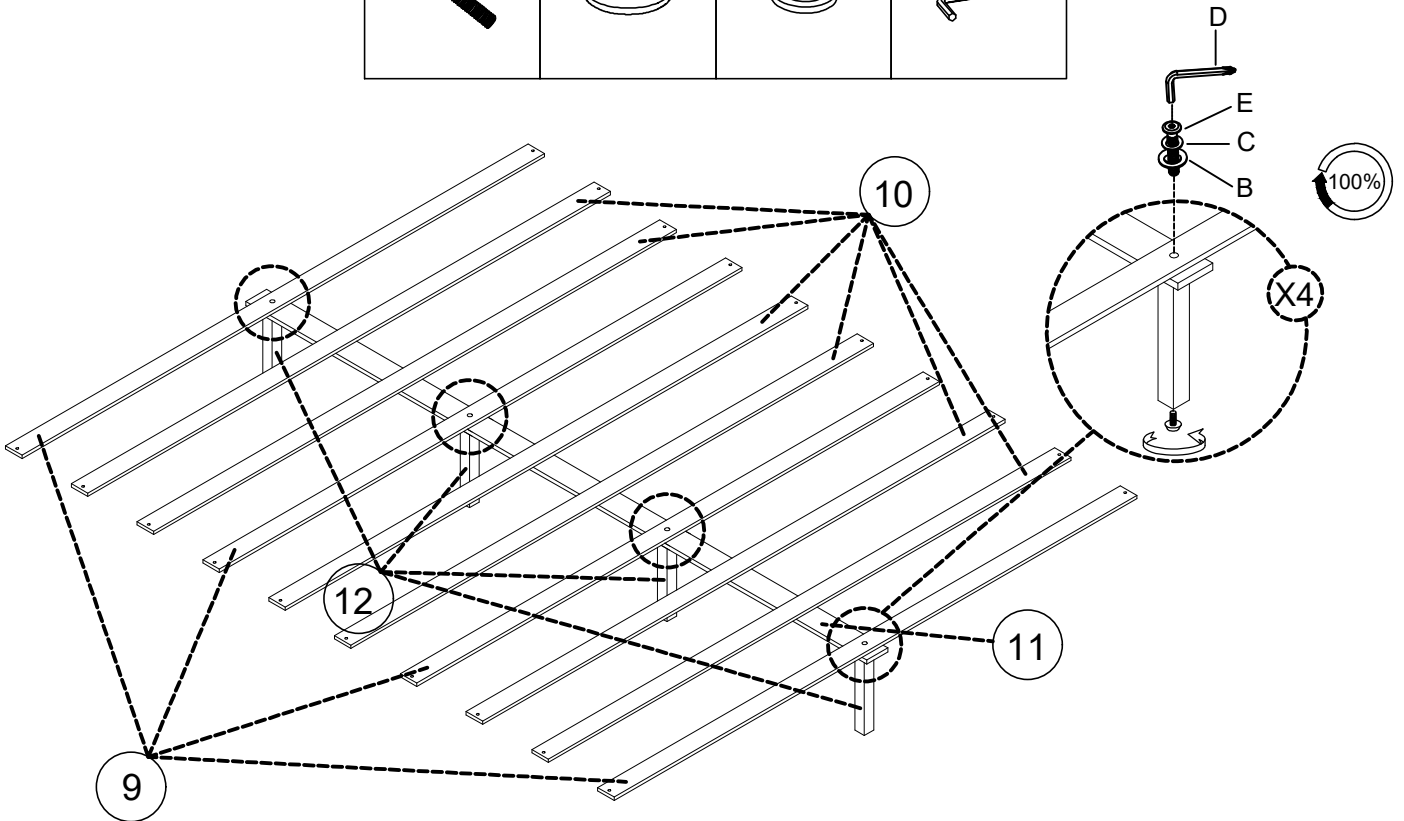
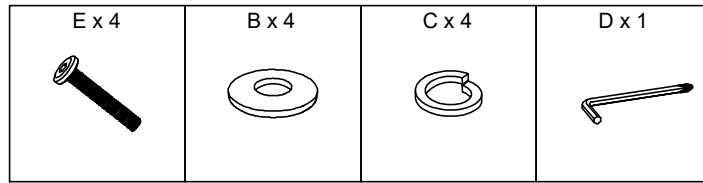

STEP 9

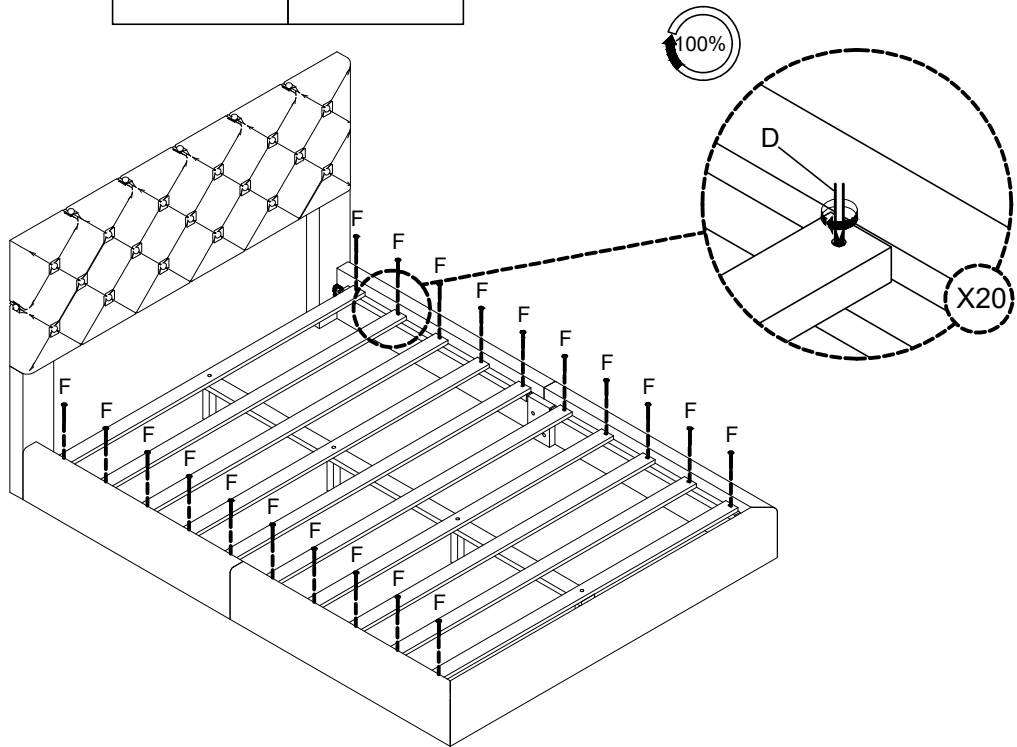
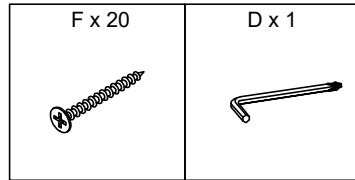

COMPLETE

