

ASSEMBLY INSTRUCTION

MF322835

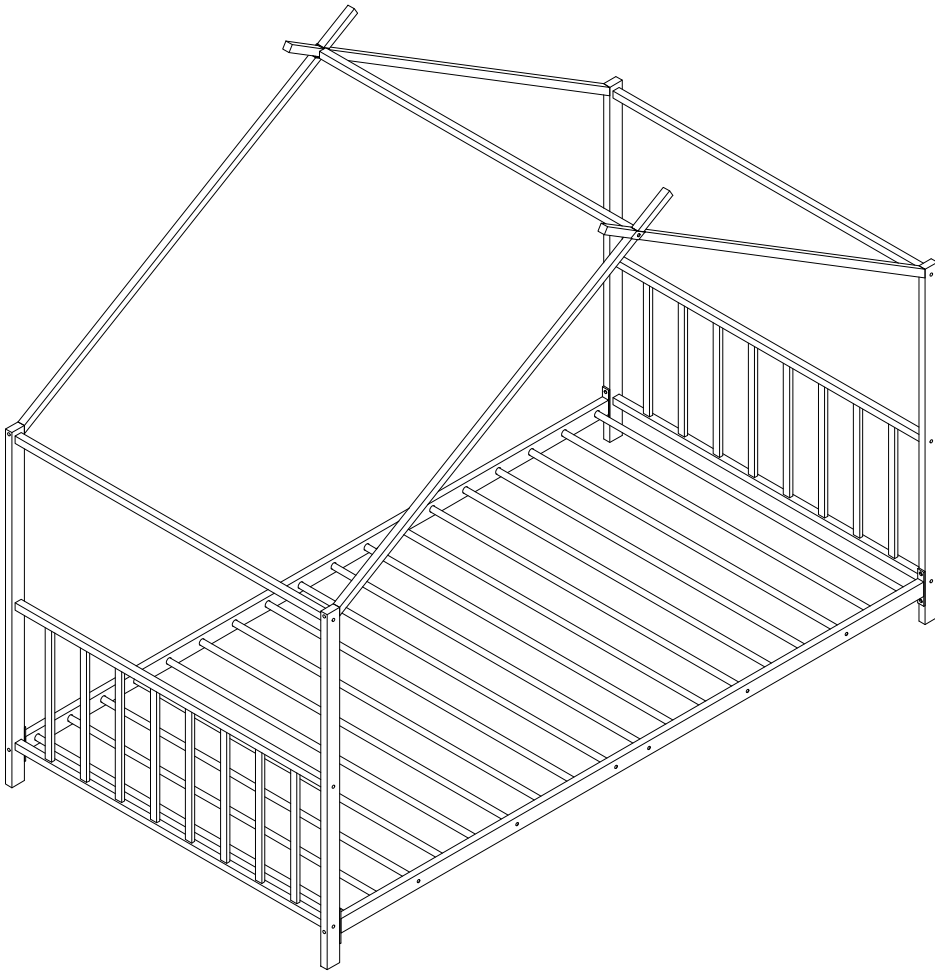

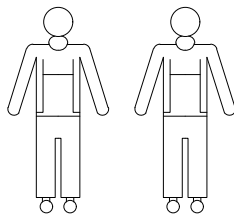

Minimum no. 2 of people
recommended to assemble
this product: Approx.
assembly time: 60 mins

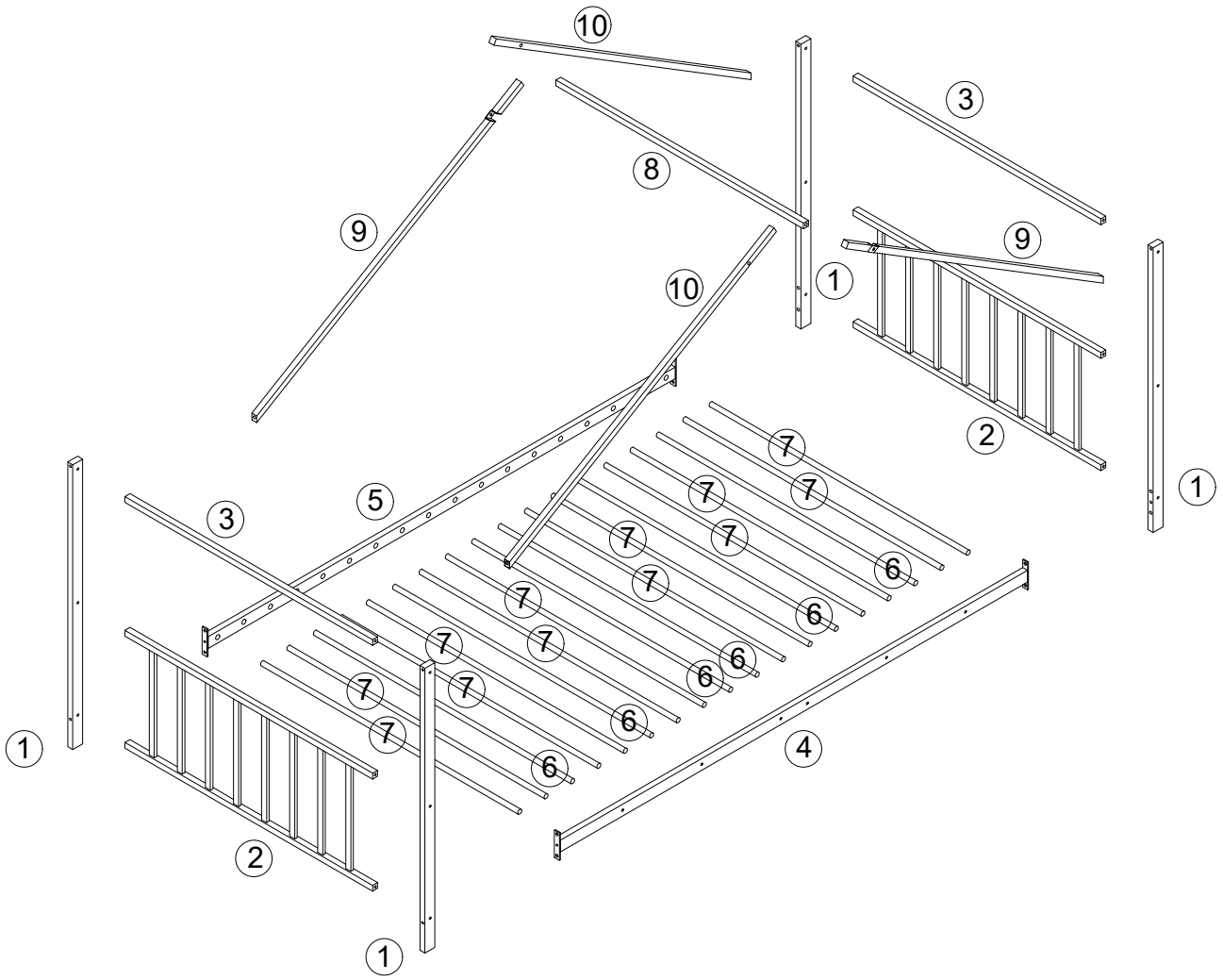



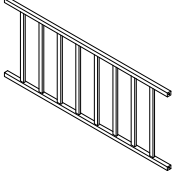
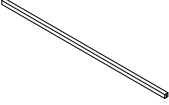
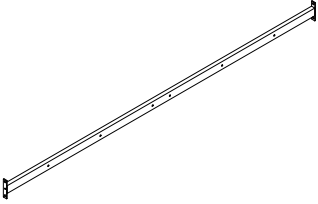
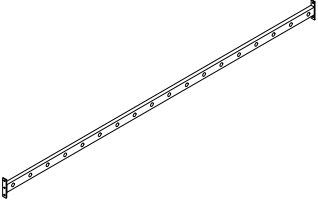
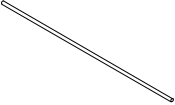
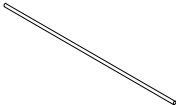
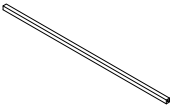



PART LIST MF322835

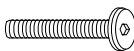

<p>1</p>  <p>4PCS</p>	<p>2</p>  <p>2PCS</p>	<p>3</p>  <p>2PCS</p>
<p>4</p>  <p>1PC</p>	<p>5</p>  <p>1PC</p>	<p>6</p>  <p>6PCS</p>
<p>7</p>  <p>12PCS</p>	<p>8</p>  <p>1PC</p>	<p>9</p>  <p>2PCS</p>
<p>10</p>  <p>2PCS</p>		

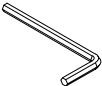
HARDWARE LIST MF322835

<p>A</p>  <p>M$\frac{1}{4}$"X55 4 PCS</p>	<p>B</p>  <p>M$\frac{1}{4}$"X50 4 PCS</p>	<p>C</p>  <p>M$\frac{1}{4}$"X35 14 PCS</p>	<p>D</p>  <p>M$\frac{1}{4}$"X15 20 PCS</p>	<p>E</p>  <p>#20x40x13 4 PCS</p>
<p>F</p>  <p>#20x20x16 4PCS</p>	<p>G</p>  <p>M4X23X57 1PC</p>			

STEP 1

2 SET

C	E
 M $\frac{1}{4}$ x35	 #20x40x13
12 PCS	4 PCS

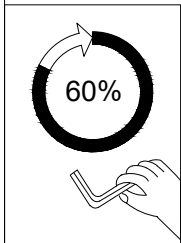
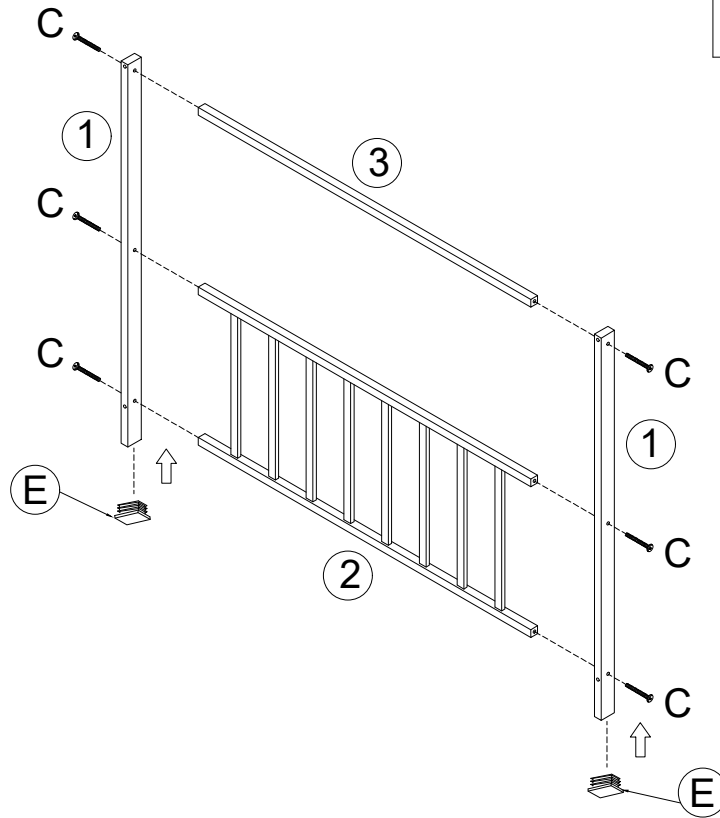

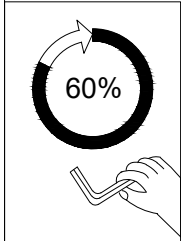
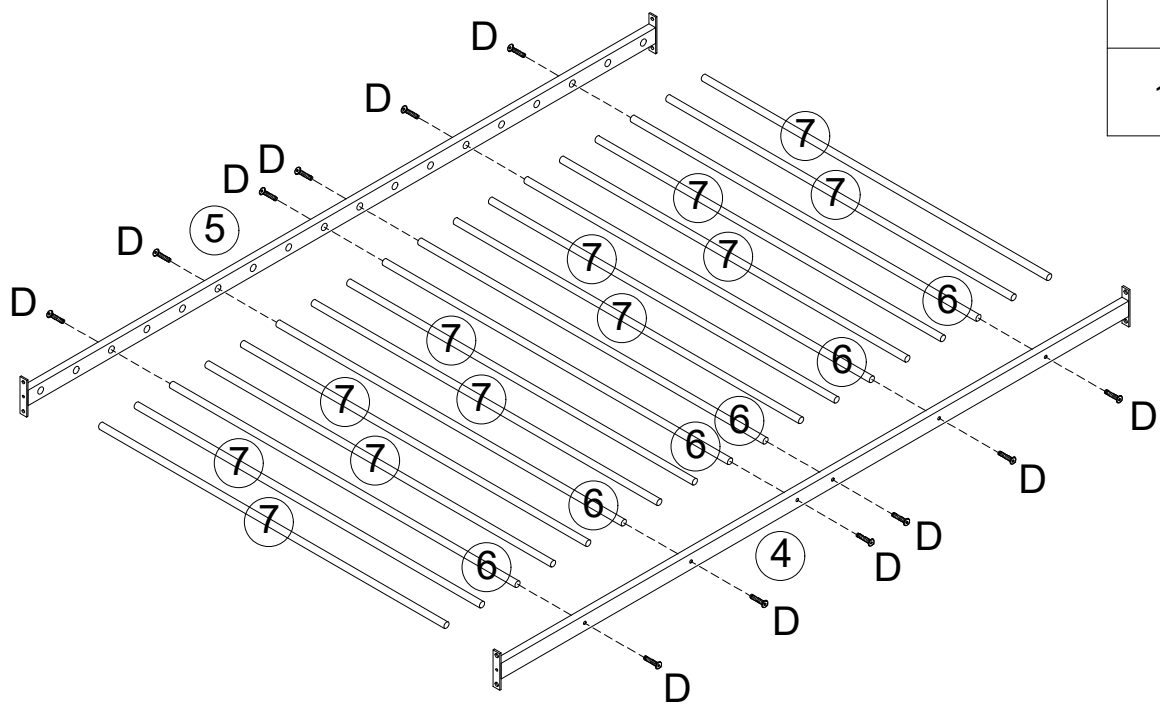

STEP 2

D
 M $\frac{1}{4}$ x15
12 PCS



STEP 3

A	D
 M $\frac{1}{4}$ "x55	 M $\frac{1}{4}$ "x15
4 PCS	8 PCS

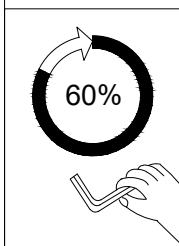
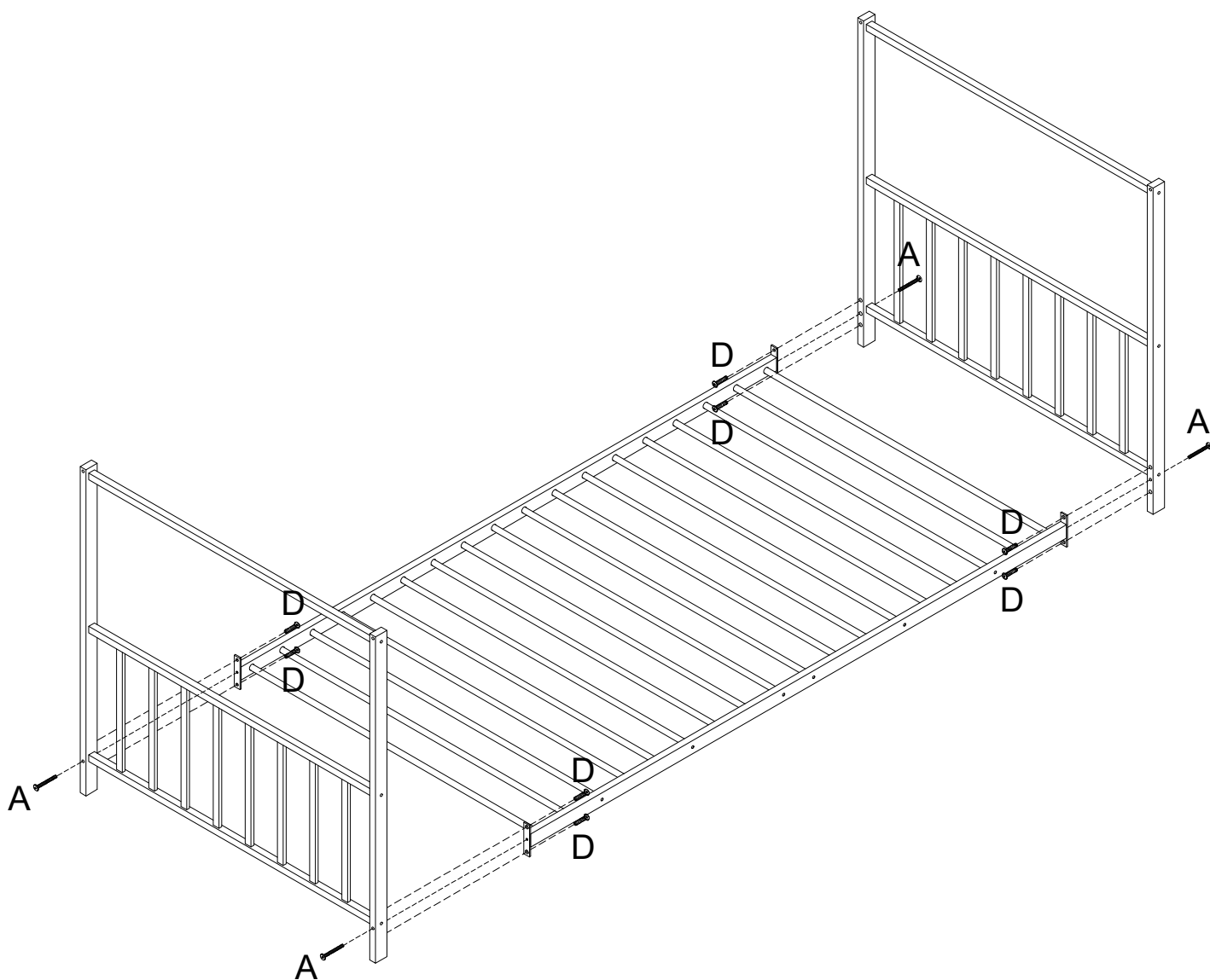

STEP 4

B



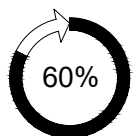
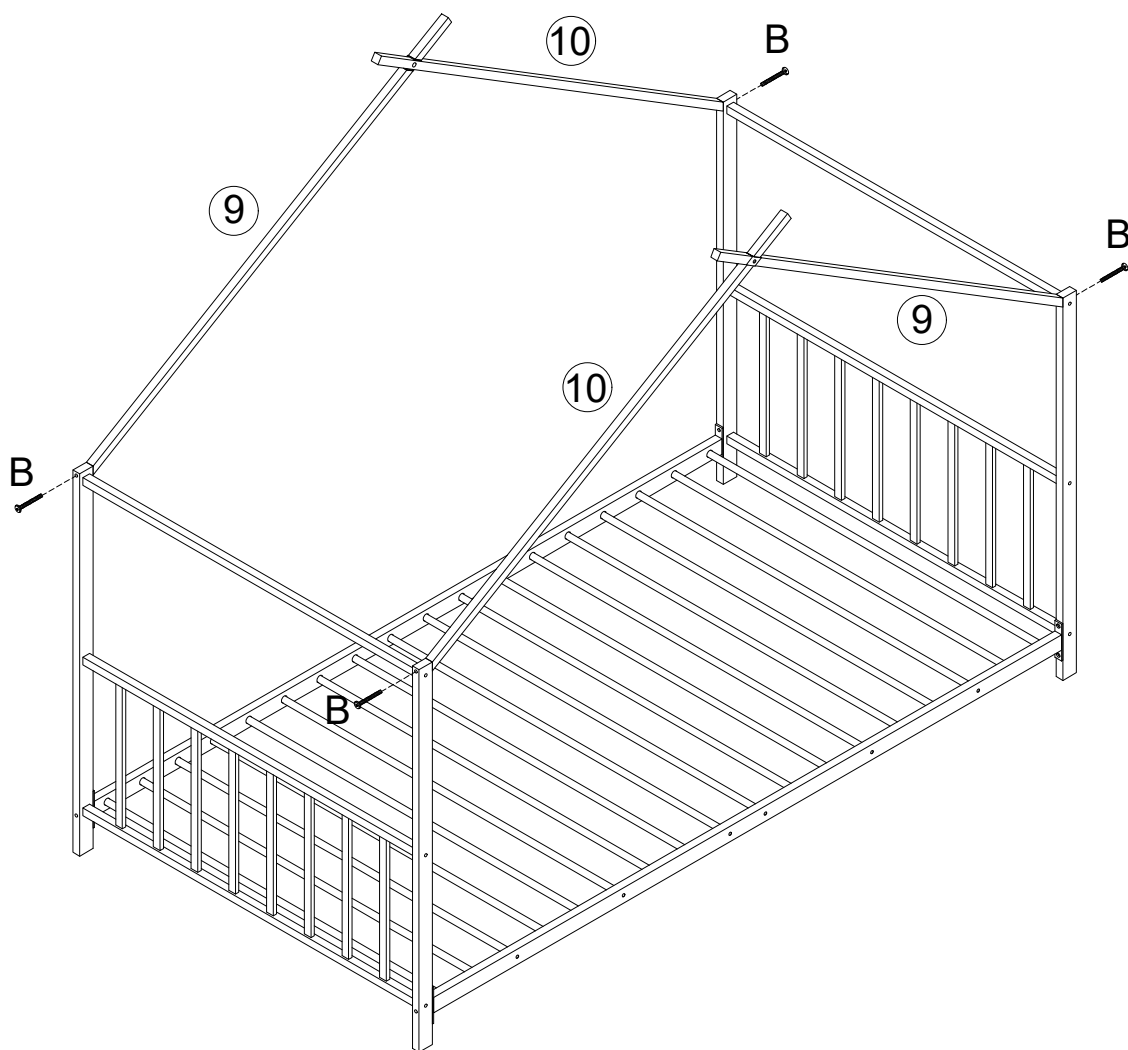

M $\frac{1}{4}$ x50

4 PCS



STEP 5

C	F
 M $\frac{1}{4}$ x35	 #20x20x13
2 PCS	4 PCS

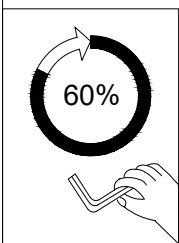
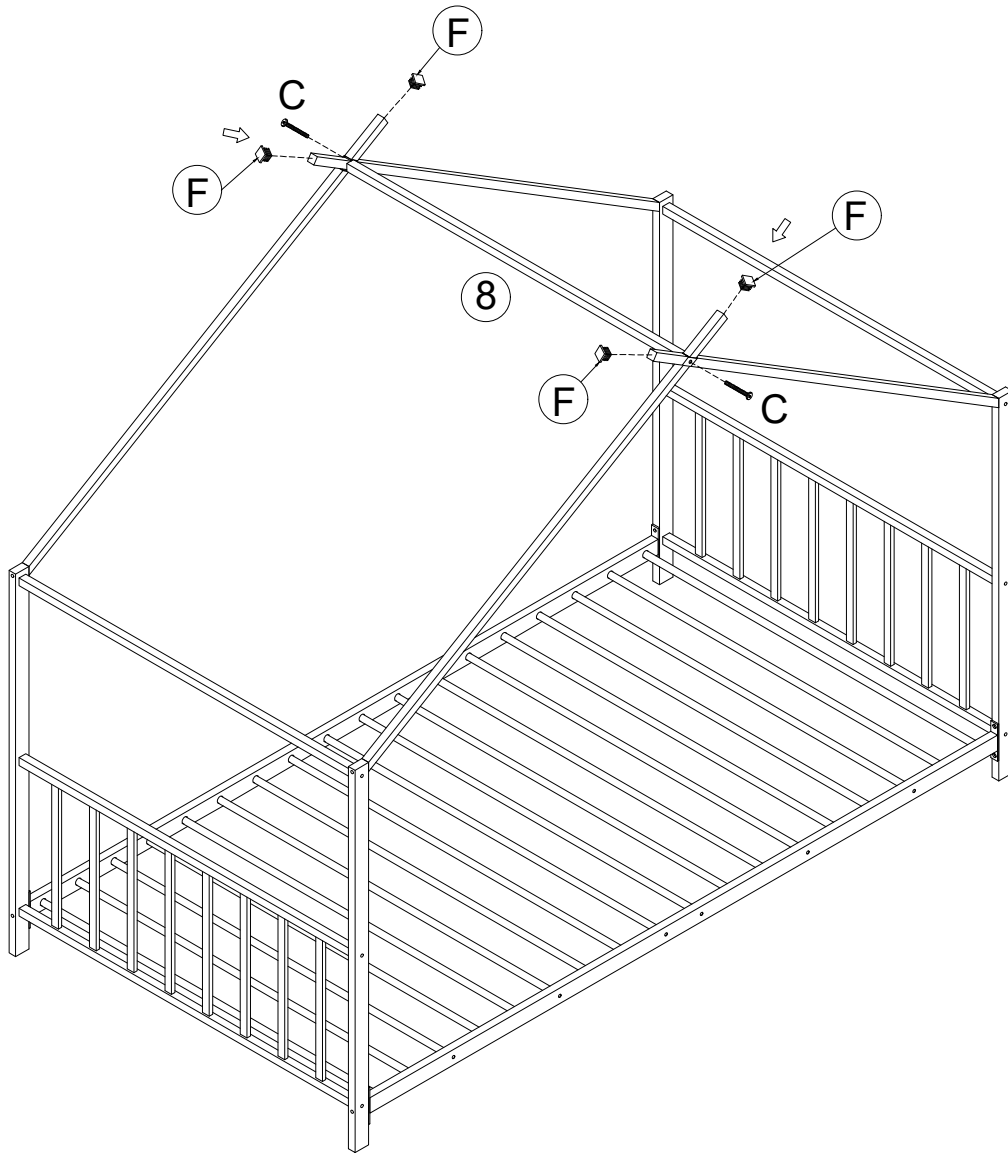

STEP 6

