

ASSEMBLY INSTRUCTION

MF315932

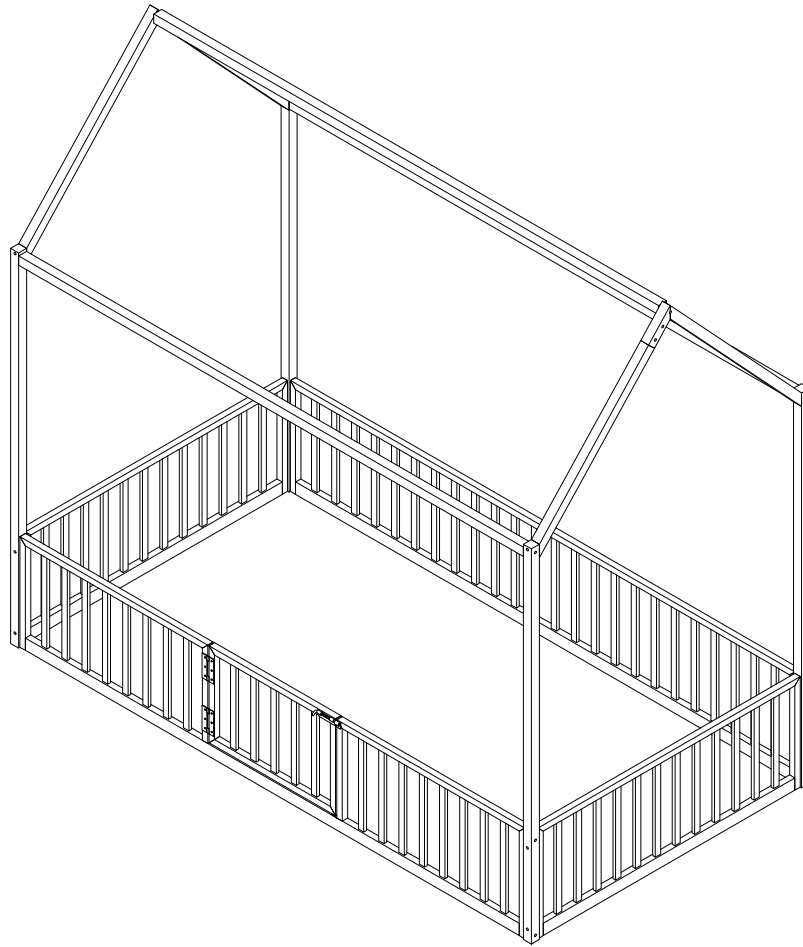

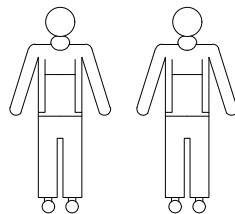

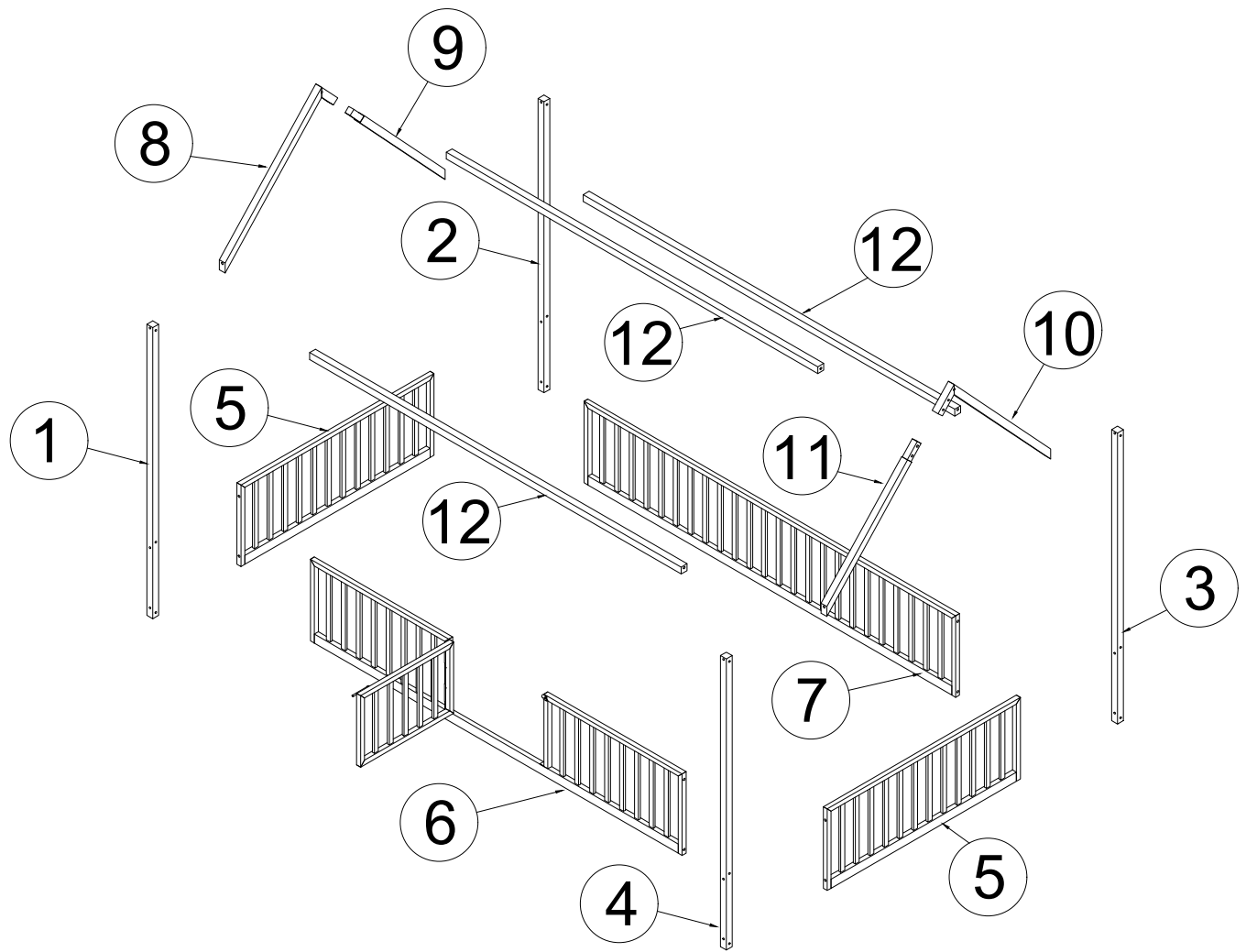

Minimum no. 2 of people
recommended to assemble
this product: Approx.
assembly time: 60 mins







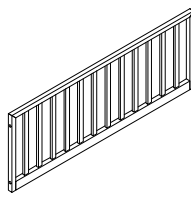
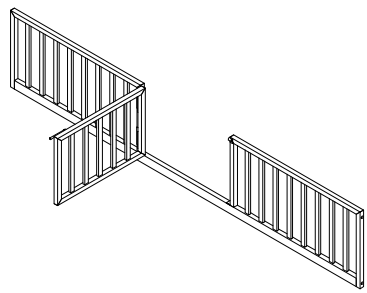
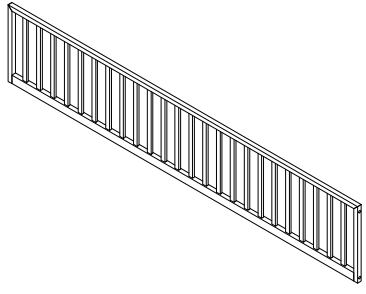
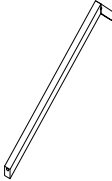
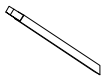
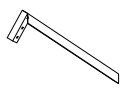
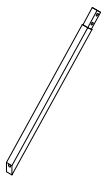
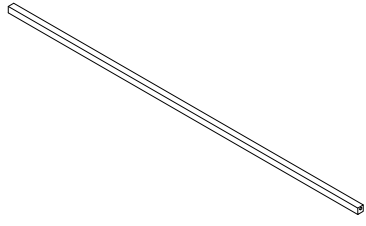

PART LIST MF315932

<p>1</p>  <p>1PC</p>	<p>2</p>  <p>1PC</p>	<p>3</p>  <p>1PC</p>
<p>4</p>  <p>1PC</p>	<p>5</p>  <p>2PCS</p>	<p>6</p>  <p>1PC</p>
<p>7</p>  <p>1PC</p>	<p>8</p>  <p>1PC</p>	<p>9</p>  <p>2PCS</p>
<p>10</p>  <p>1PC</p>	<p>11</p>  <p>1PC</p>	<p>12</p>  <p>3PCS</p>

HARDWARE LIST MF315932

<p>A</p>  <p>26PCS M$\frac{1}{4}$"X45</p>	<p>B</p>  <p>4PCS M$\frac{1}{4}$"X15</p>	<p>C</p>  <p>4PCS #30x30x13</p>	<p>D</p>  <p>1PC M4X23X57</p>
---	--	---	--

STEP 1

B



M $\frac{1}{4}$ x 15

2 PCS

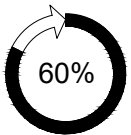
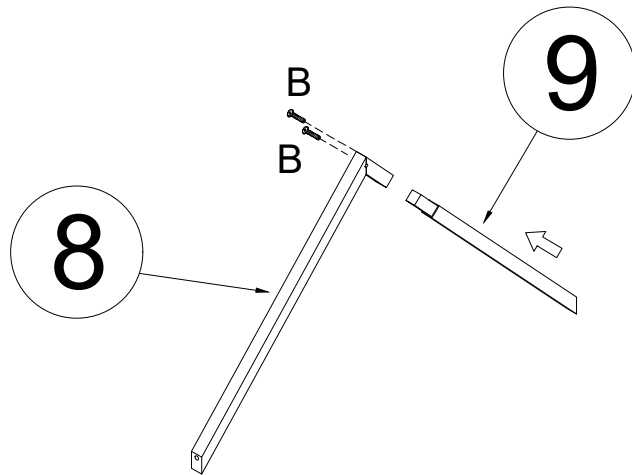

60%



STEP 2

B



M $\frac{1}{4}$ x 15

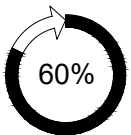
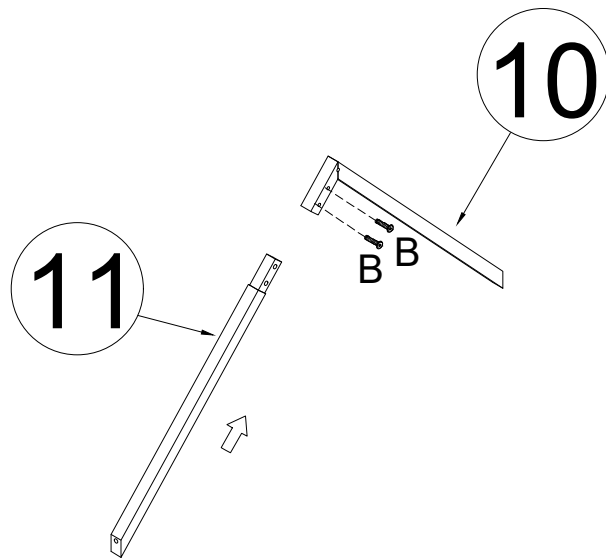

2 PCS



60%



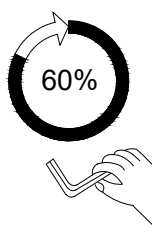
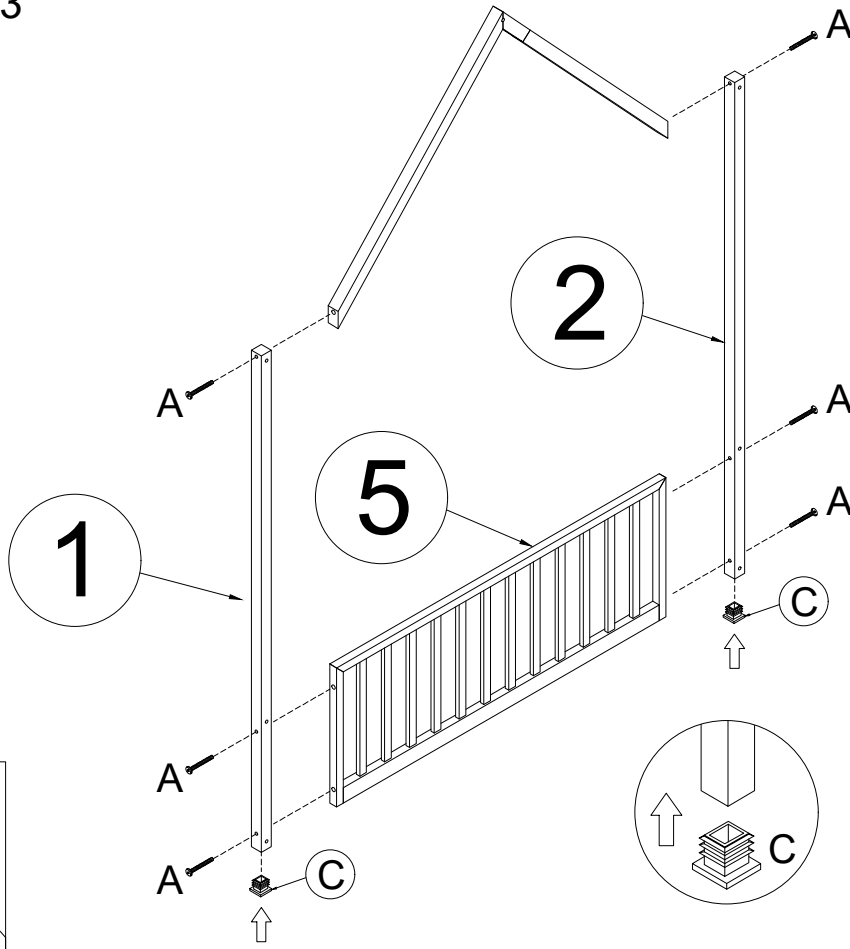

STEP 3

A	C
 M $\frac{1}{4}$ "x45	 #30x30x13
6 PCS	2 PCS



STEP 4

A	C
 M $\frac{1}{4}$ "x45	 #30x30x13
6 PCS	2 PCS

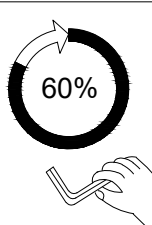
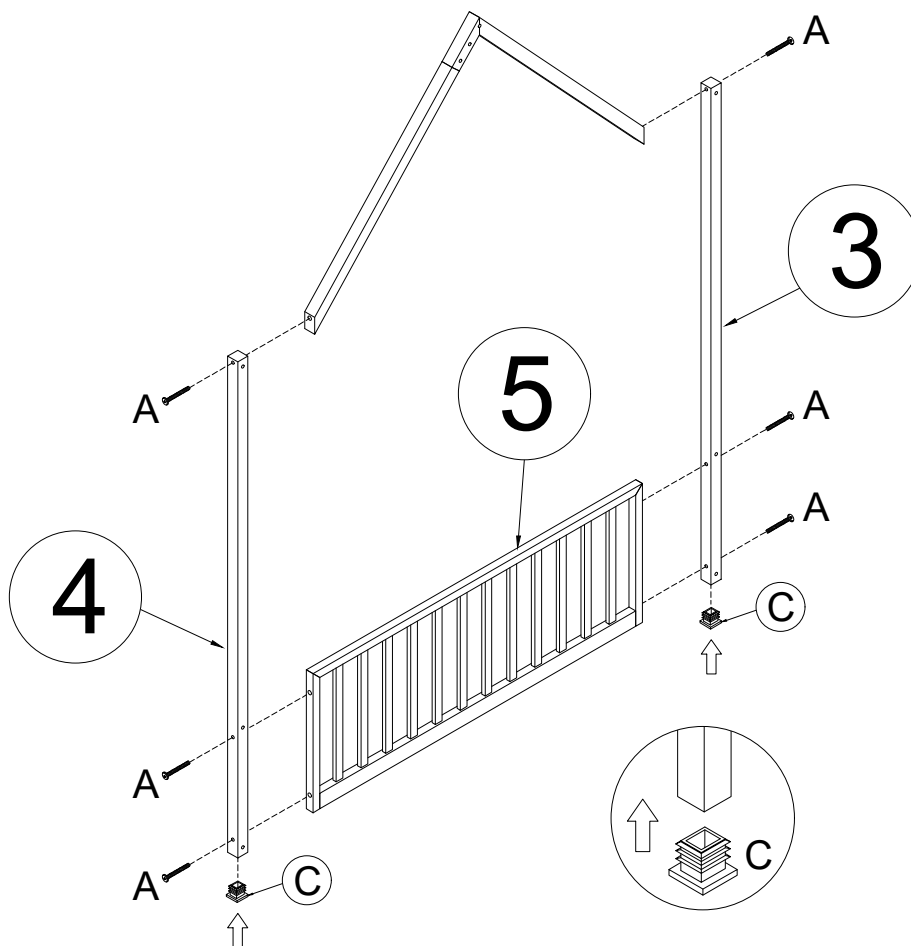

STEP 5

A



M $\frac{1}{4}$ "x45

14 PCS

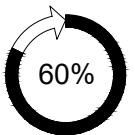
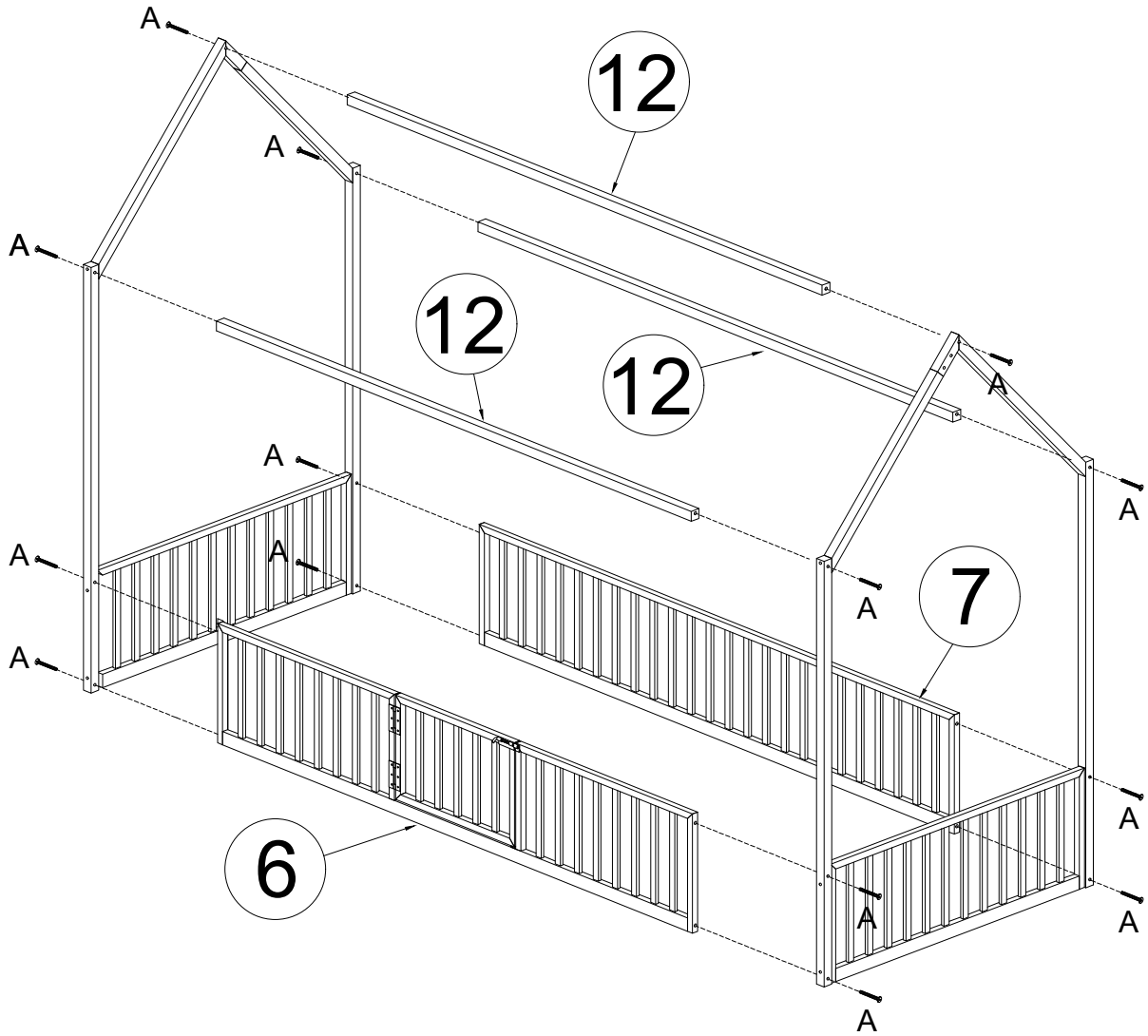

STEP 6

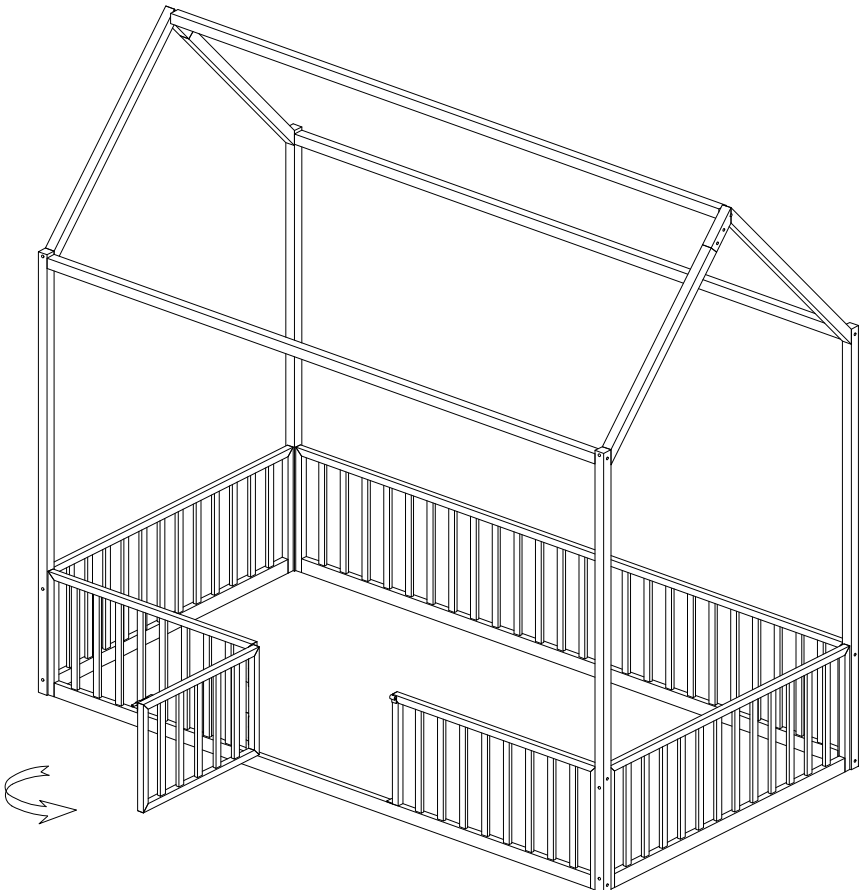

STEP 7

