

ASSEMBLY INSTRUCTIONS

GOLD QUEEN BED

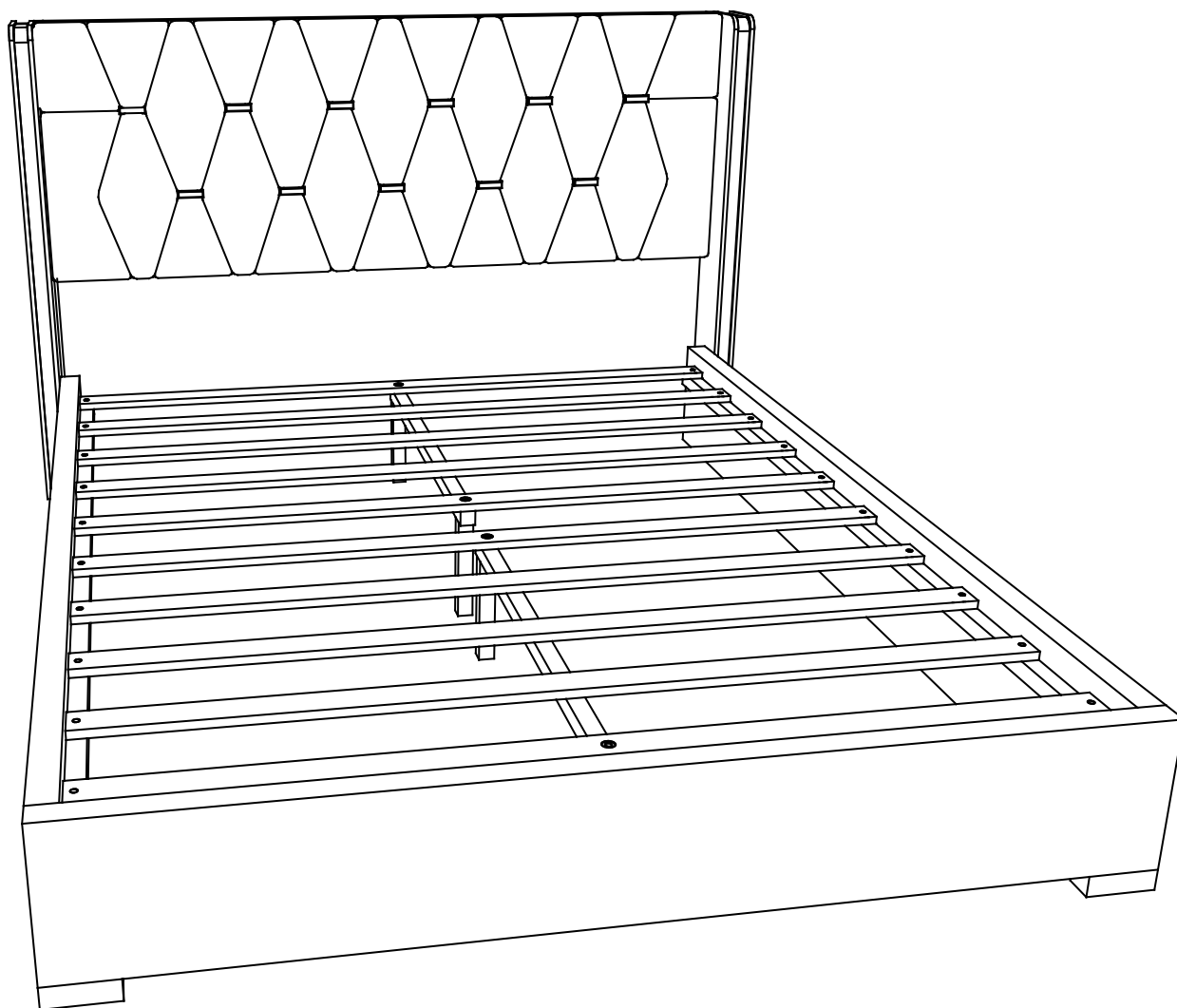

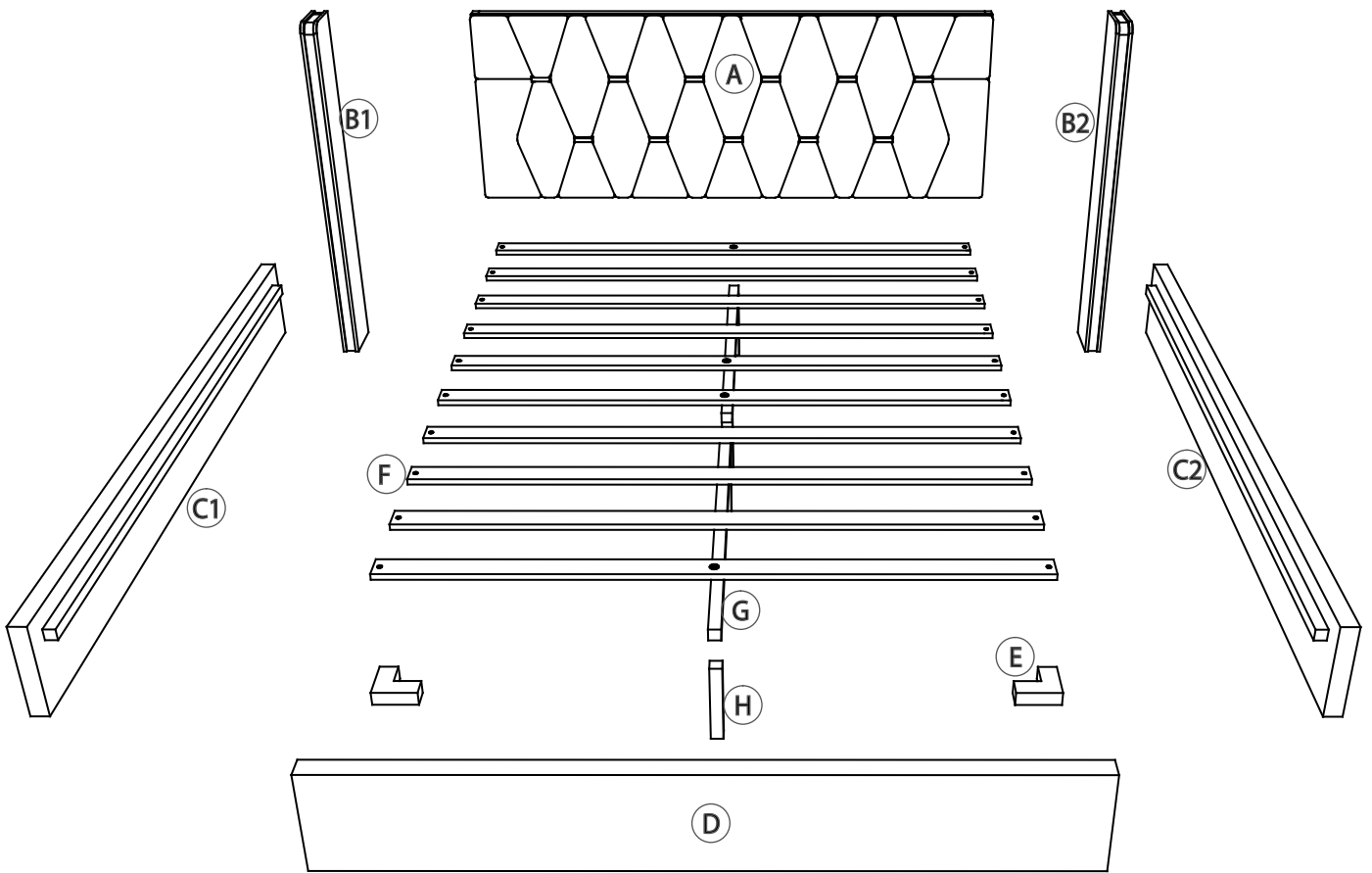

WF319928 & WF319929

Detail View





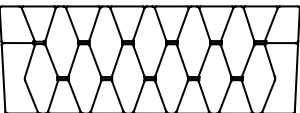

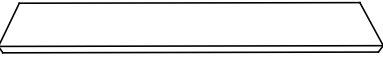
Part List

WF319928

A		B1		B2	
HEADBOARD - 1PC		LEFT HEADBOARD LEG - 1PC		RIGHT HEADBOARD LEG - 1PC	
D					
FOOTBOARD - 1PC					

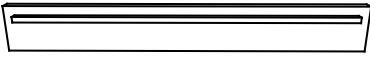

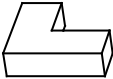

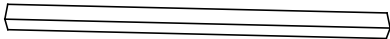
Part List

WF319929

C1  LEFT SIDE RAIL - 1PC	C2  RIGHT SIDE RAIL - 1PC	G  CENTER SUPPORT LEGS - 4PCS
E  FOOTBOARD LEGS - 2PCS	F  SLATS - 10PCS	H  CENTER SUPPORT BAR - 1PC

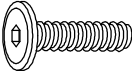
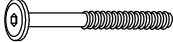
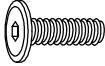
Hardware List

in WF319929

1  Allen key (1pc)	2  5/16"*45mm Hex-Head bolts (8pcs)	3  1/4"*60mm Hex-Head bolts (4pcs)
4  5/16"*25mm Hex-Head bolts (4pcs)	5  5/16" Flat Washer (12pcs)	6  1/4" Flat Washer (4pcs)
7  F4*35mm Screw (24pcs)		

ASSEMBLY TOOLS REQUIRED (NOT INCLUDED)

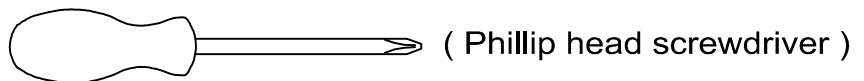

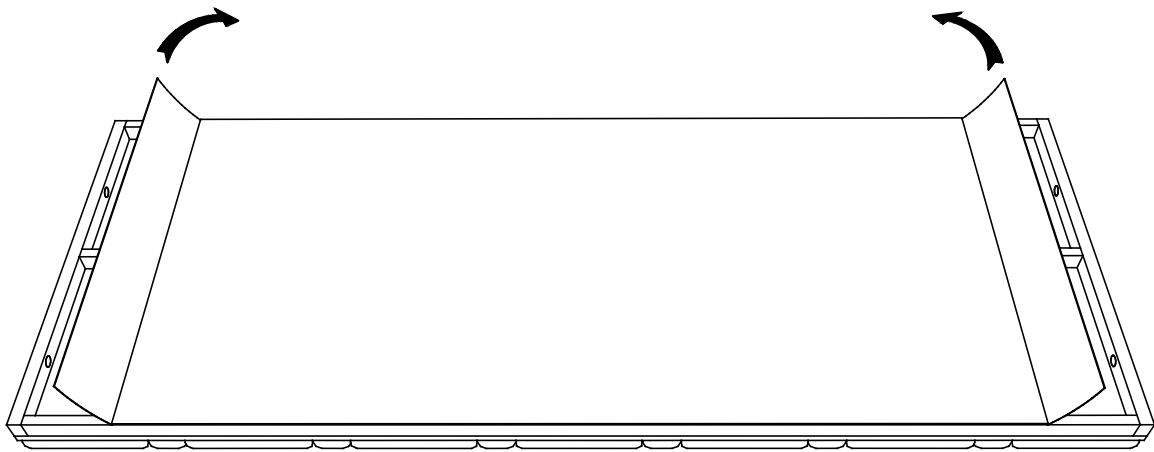

DO NOT USE POWER TOOLS TO ASSEMBLE THIS PRODUCT !

STEP 1:



- Open both sides of the black non-woven fabric on HeadBoard (A).

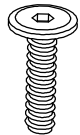

STEP 2:

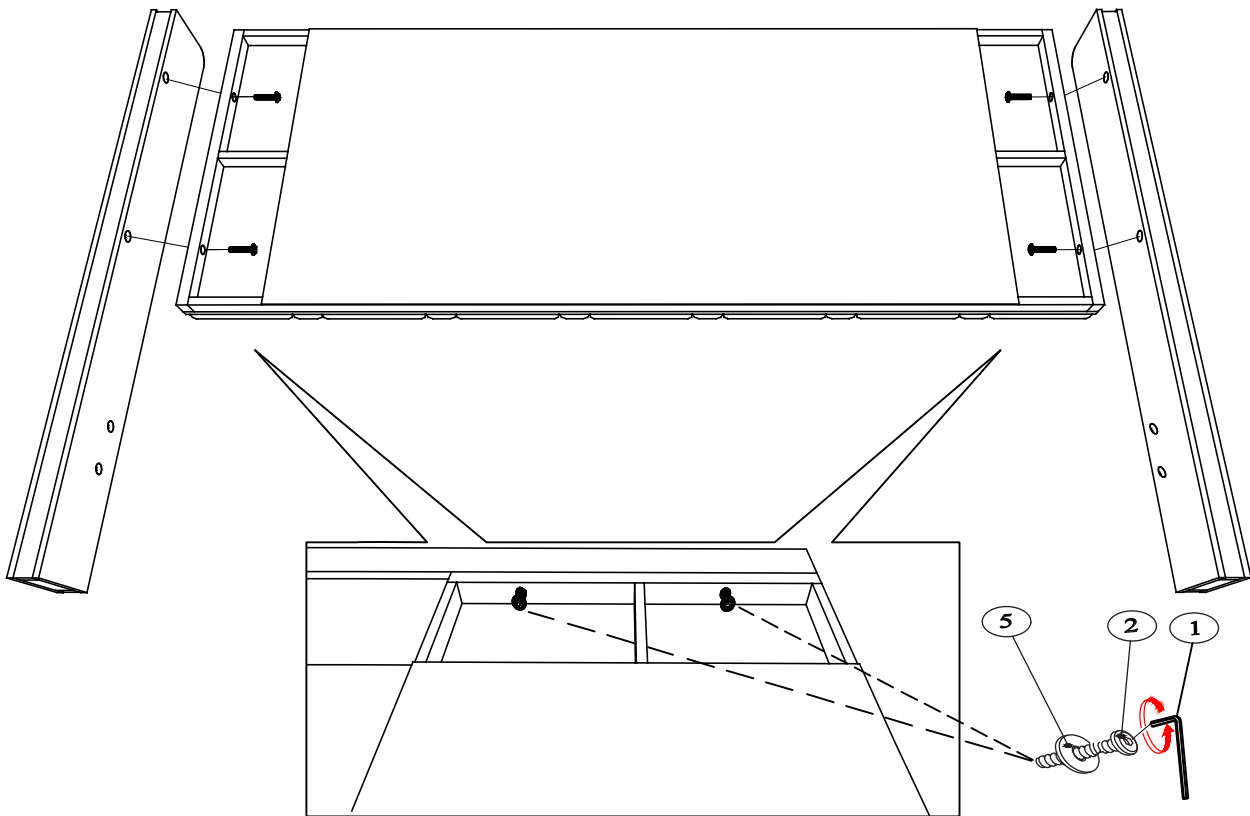
2		5	
4PCS		4PCS	

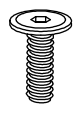

- Use Allen Key (1) to drive Bolt (2) fitted with Spring Washer (5) to install the Left & Right HeadBoard Leg (B1&B2) to the HeadBoard (A).

STEP 3:

4		5	
4PCS		4PCS	

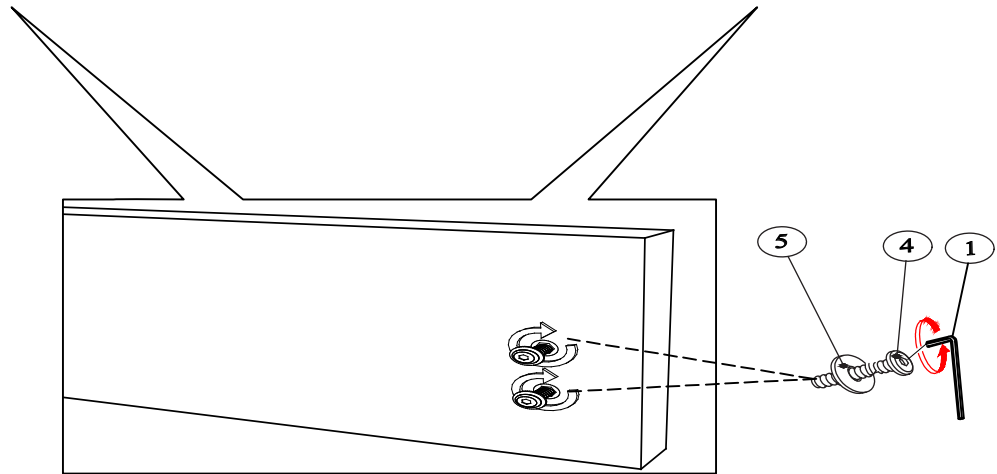
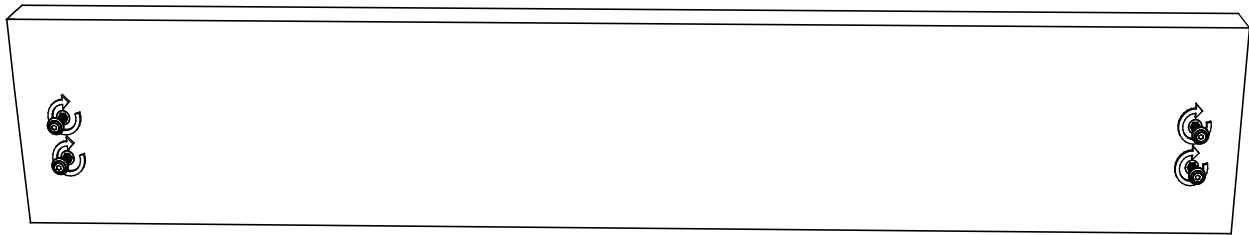

- Use Allen Key (1) to loosely (do not tighten) drive Bolt (4) with Spring Washer (5) onto the Footboard (D).

STEP 4:

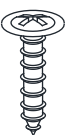
7	
4PCS	

- Use the ScrewDriver to install the Screw (7) on FootBoard Leg (E) into the FootBoard (D).

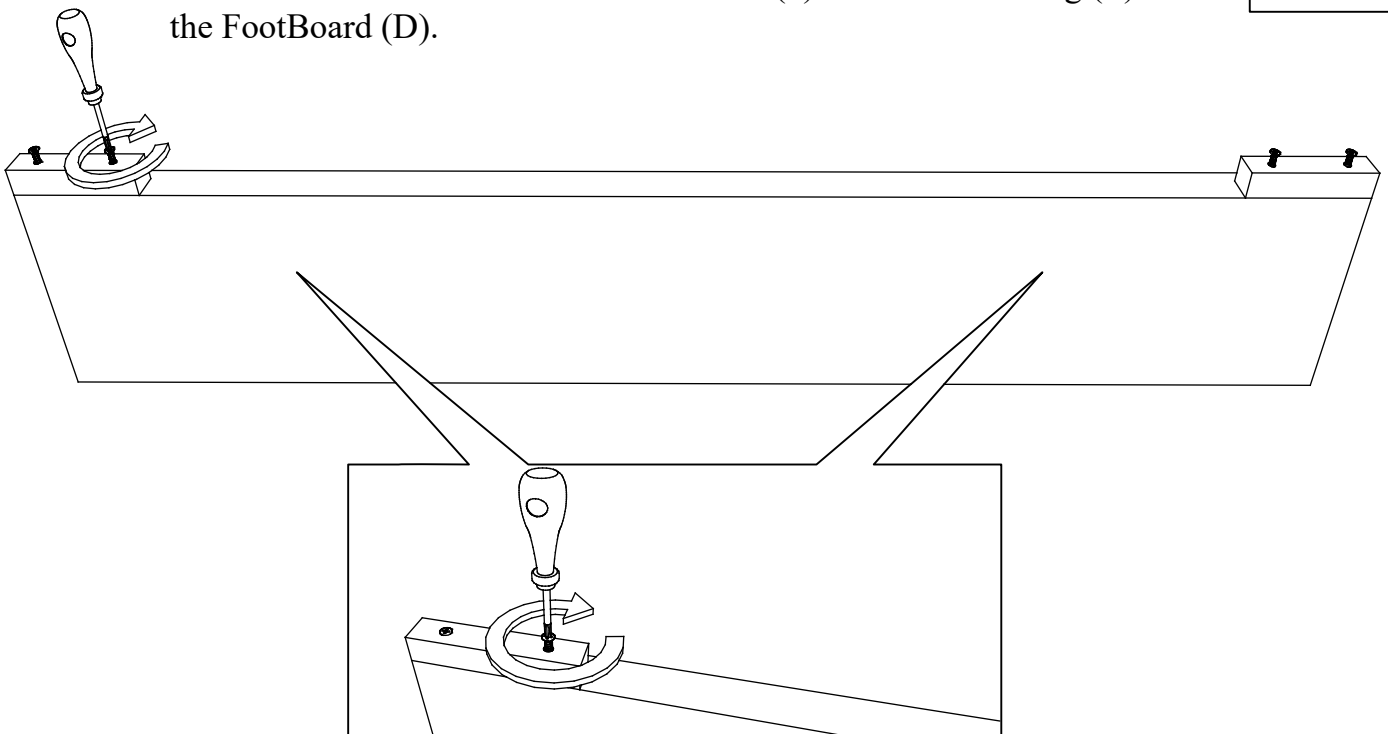

STEP 5:

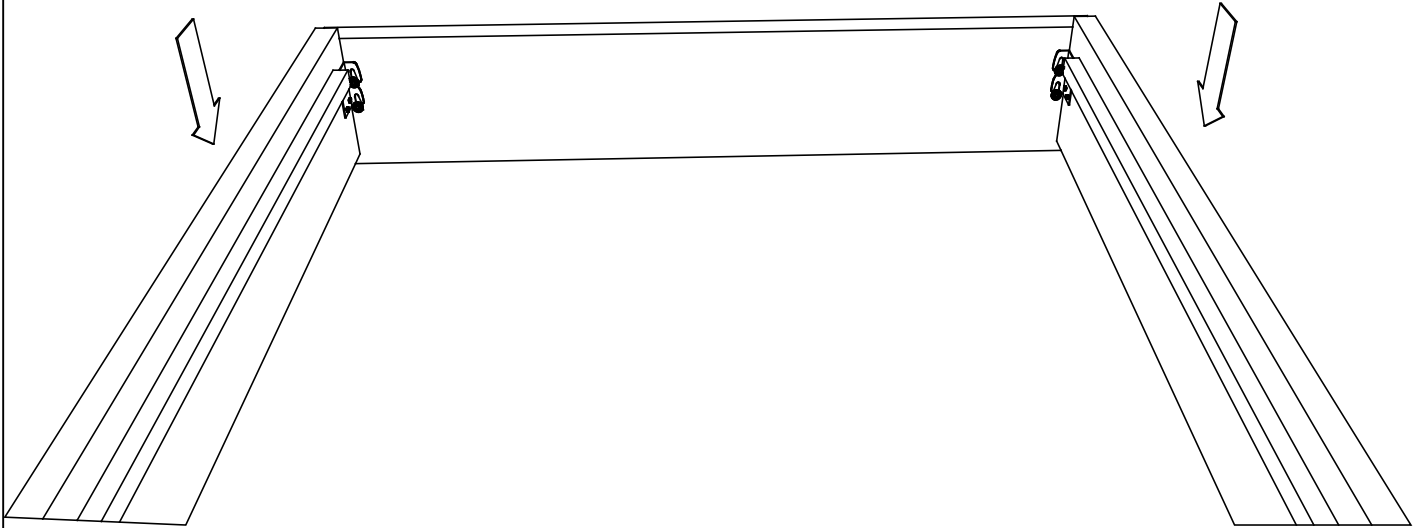

- Place the hook of Left&Right Side Rail (C1&C2) to Bolt (4) on Footboard (D). Then tighten the Bolt (4) fully.

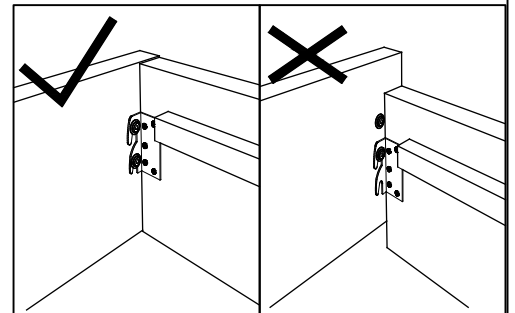

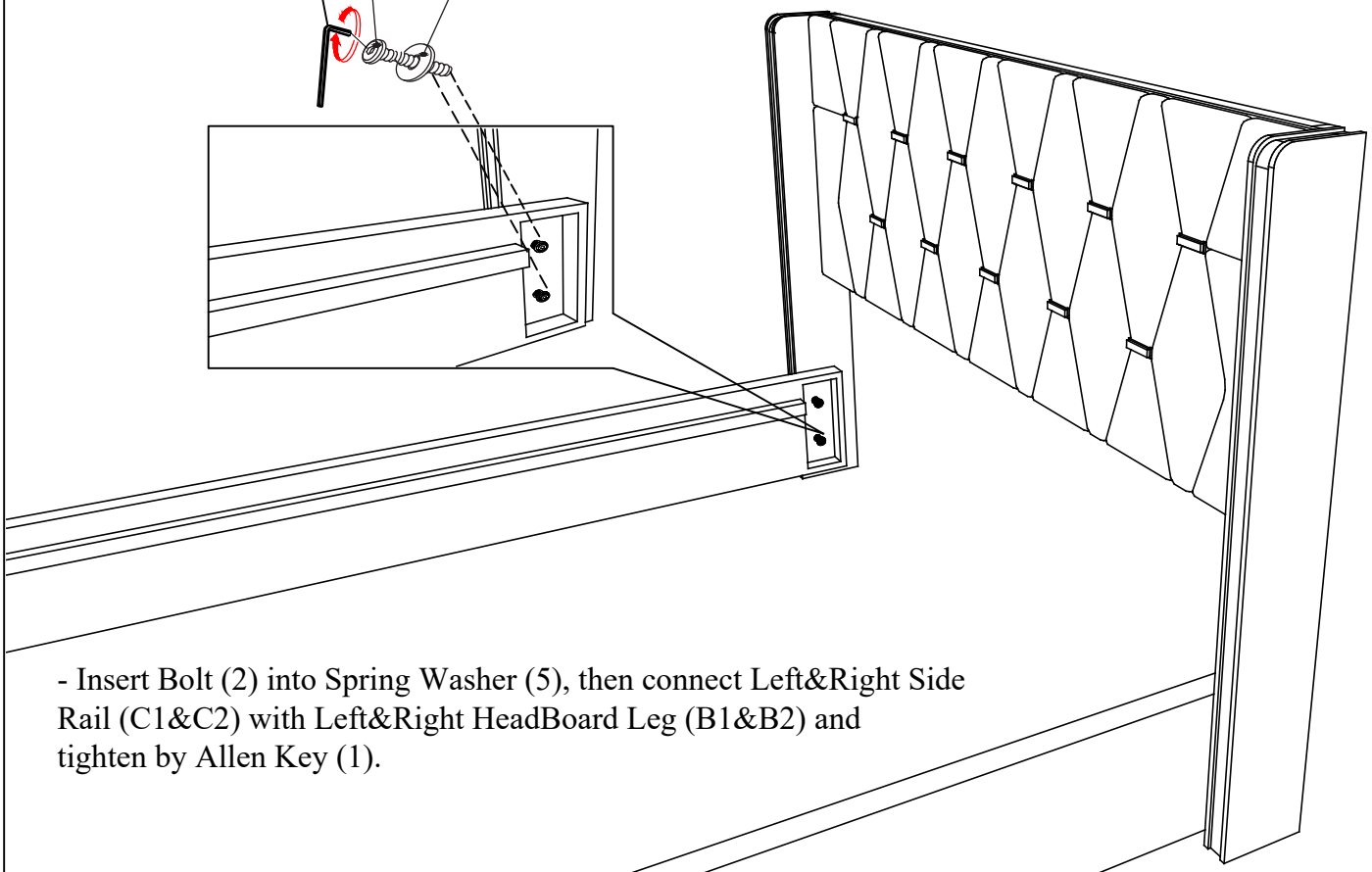
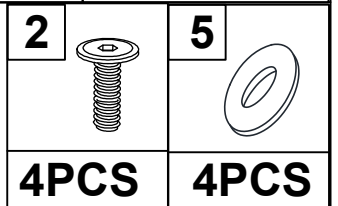
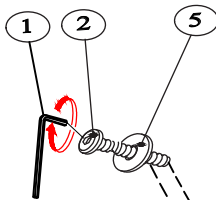

STEP 6:

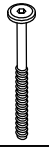

- Insert Bolt (2) into Spring Washer (5), then connect Left&Right Side Rail (C1&C2) with Left&Right HeadBoard Leg (B1&B2) and tighten by Allen Key (1).

STEP 7:

3		6		7	
4PCS		4PCS		20PCS	

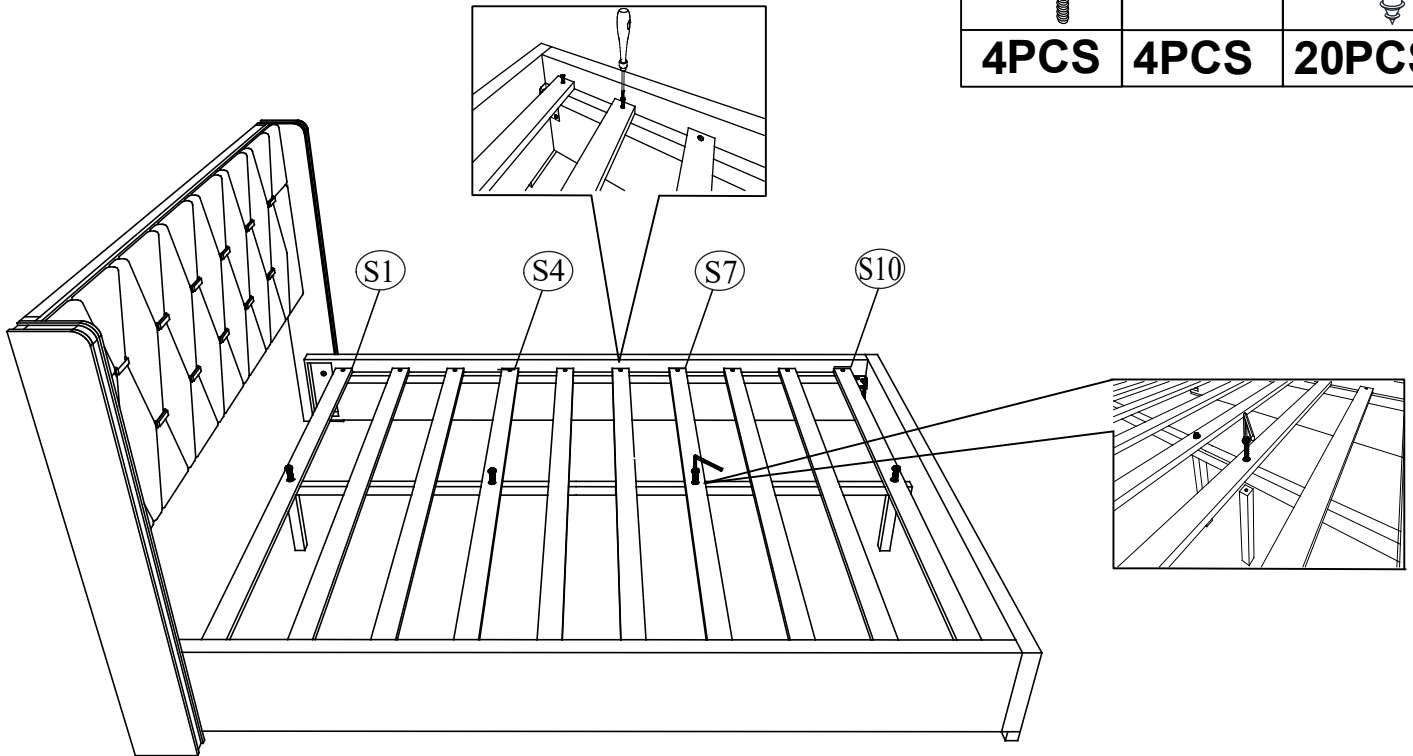

- Set Bolt (3) into Spring Washer (6), then pass assembled Bolts through Slats (S1,S4,S7,S10) and Center Support Bar (H) in turn, fit into Center Support Legs (G) then tighten with Allen Key (1).
- Use the ScrewDriver to install the Screw (7) into the hole on 2 heads of the Slats (F).

STEP 8:

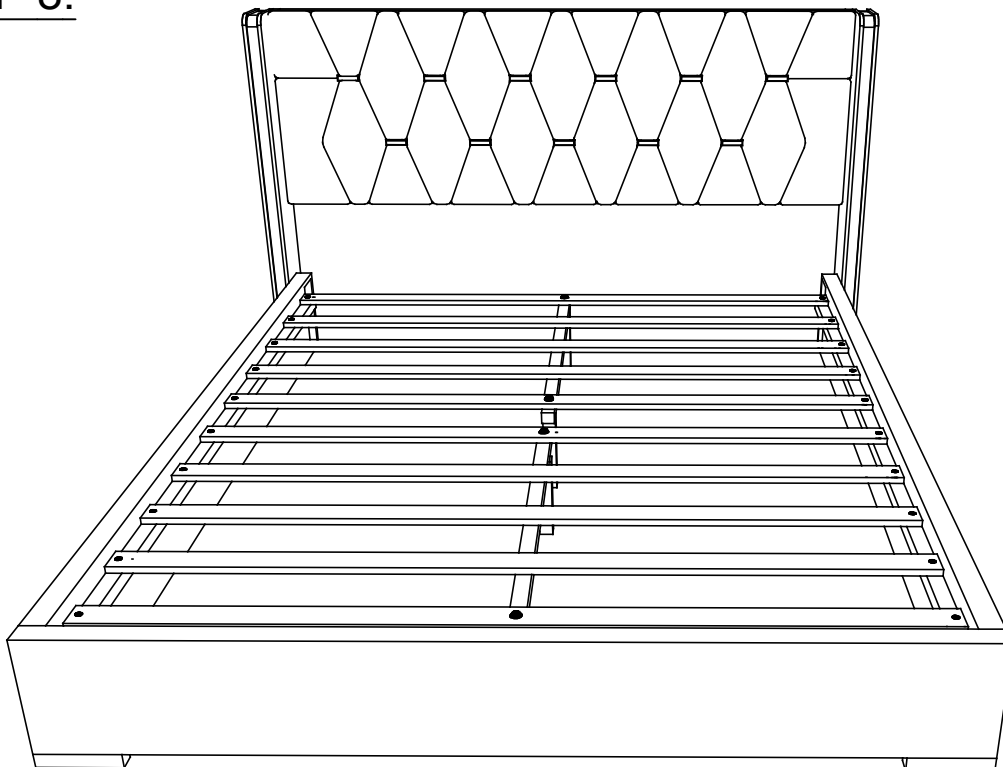

THE BED IS COMPLETE !