

ASSEMBLY INSTRUCTION

WF318622 / WF318623 (Full)

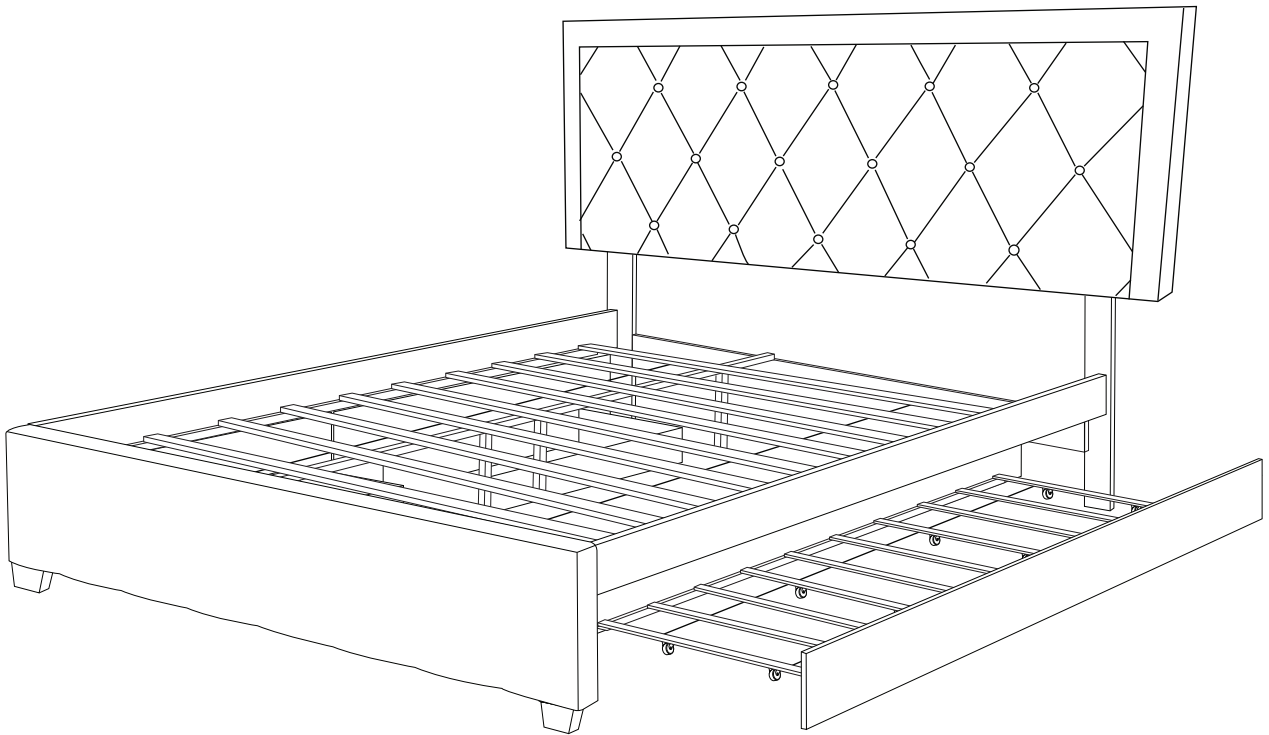

WF318624 / WF318625 (Queen)

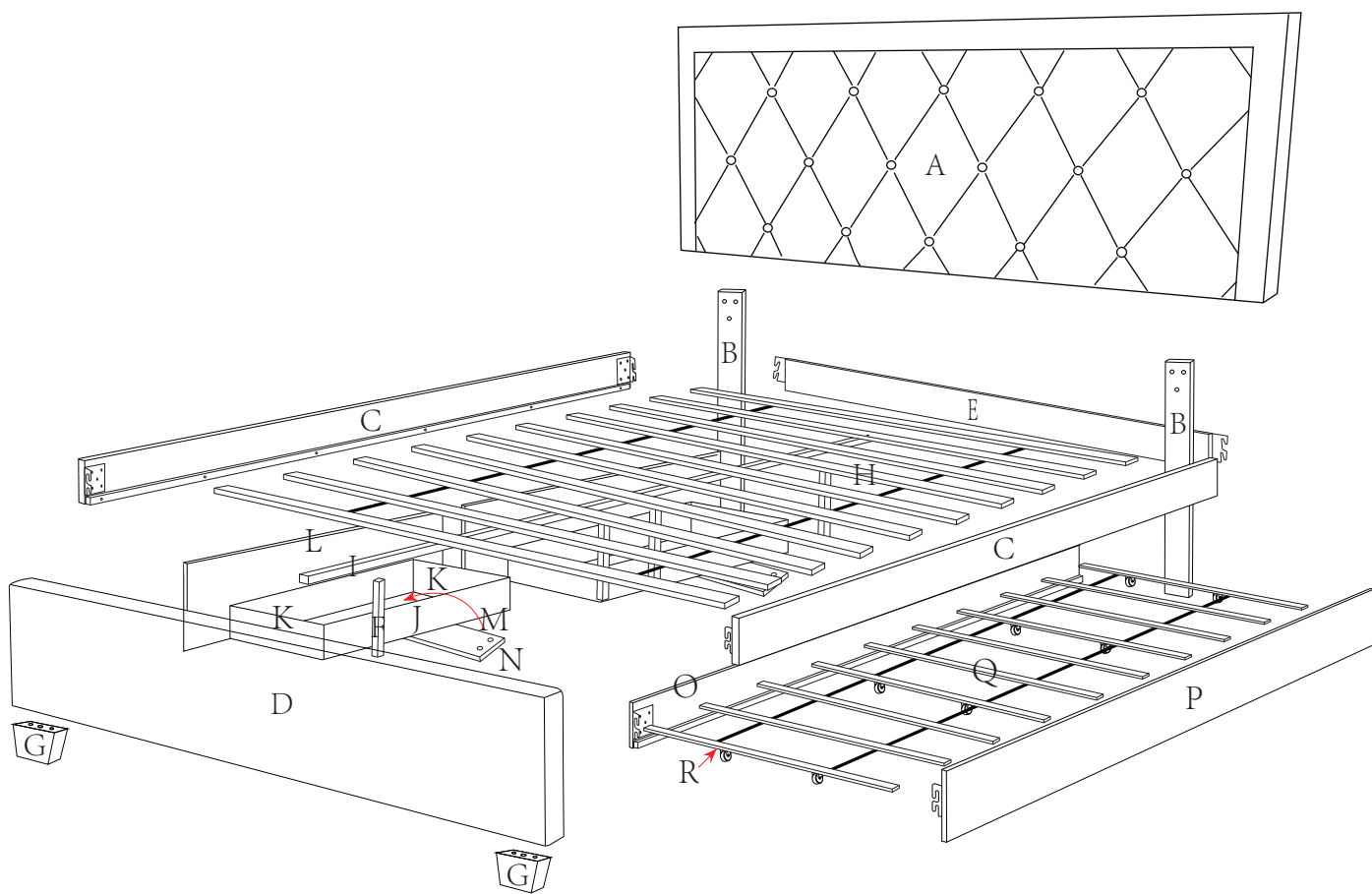



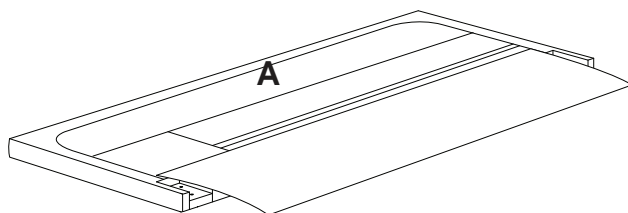

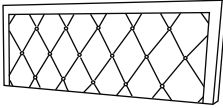
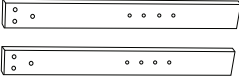

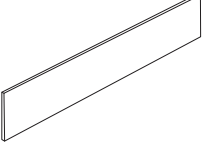
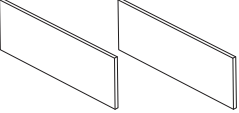
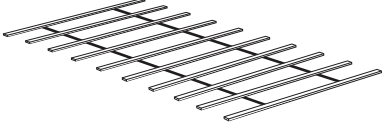
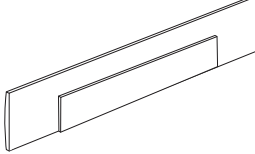
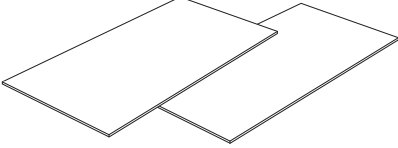
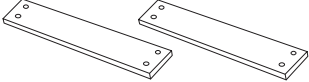



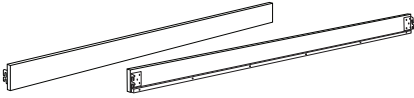
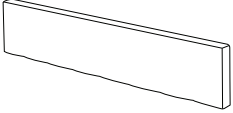

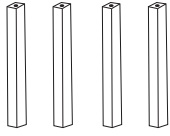
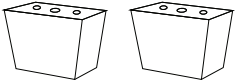
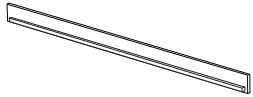
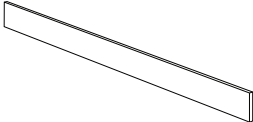
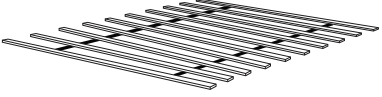
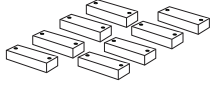
Bed Parts are shipped inside a compartment
in the storage of the headboard.

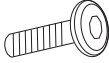

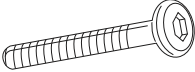
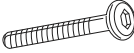
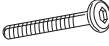
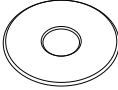

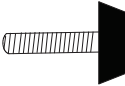

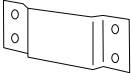

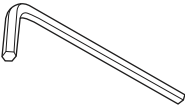
NO	PART LIST (BOX 1 OF 2) WF318622 / WF318624	QTY
A	Headboard 	1 pc
B	Headboard Leg 	2 pcs
E	Headboard Support Bar 	1 pc
J	Drawer Back Panel 	2 pcs
K	Drawer Side Panel 	4 pcs
Q	Trundle Bed Slat (Twin) 	10 pcs
L	Drawer Front Panel 	2 pcs
M	Drawer Bottom Panel 	2 pcs
N	Drawer Support 	2 pcs

PARTLIST (BOX 2 OF 2) WF318623 / WF318625

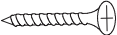
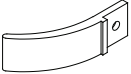
C	Side Rail		2 pcs
D	Footboard		1 pc
I	Center Support Rail		1 pc
F	Center Support Leg		4 pcs
G	Bed Leg		2 pcs
O	Trundle Long Panel (i)		1 pc
P	Trundle Long Panel (ii)		1 pc
H	Bed Slat Queen		10 pcs
R	Trundle Slat Cube		8 pcs

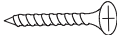
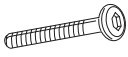
NO	HARDWARE LIST (BOX 1 OF 2) WF318623 / WF318625	QTY
1	JCBB M8 x 20mm 	8 pcs
2	JCBC M6 x 70mm 	2 pcs
3	JCBC M6 x 60mm 	4 pcs
4	JCBC M6 x 40mm 	6 pcs
5	JCBB M8 x 25mm 	4 pcs
6	Flat Washer M6 	7 pcs
7	Dowel M8 	4 pcs
8	Adjuster M6 	4 pcs
9	CSK M4 x 20mm 	10 pcs
10	U-Bracket 	1 pc
11	CSK M3.5 x 16mm 	56 pcs
12	CSK M4 x 30mm 	40 pcs
13	Allen Key M4(100mm) 	1 pc

NO	HARDWARE LIST (BOX 1 OF 2) WF318623 / WF318625	QTY
14	Allen Key M5(65mm) 	1 pc
15	CSK M4 x 38mm 	16 pcs
16	Wheel 	16 pcs
17	CSK M4 x 32mm 	16 pcs
18	Stopper 	6 pcs
19	Spring Washer M6 	6 pcs
20	CSK M4 X 25MM 	8 pcs
21	JCBC M6 x 45mm 	1 pc
22	Adapter 	1 pc
23	Switch 	1 pc

Remark : Extra hardware provided.

Read this instruction carefully. Remove all wrapping material, staples and straps from the carton. See hardware and furniture part list for guidance. Be sure you have all wooden furniture parts on a clean and flat surface, such as carpet or rug, to prevent from being scratched.

CAUTION :

1. Do not Full Tighten the nut or screw until all ready to assemble.
2. Do not Over Tighten the nut or screw to avoid causing damages to the thread.
3. Keep all hardware part out reach of children.

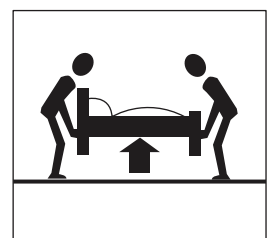
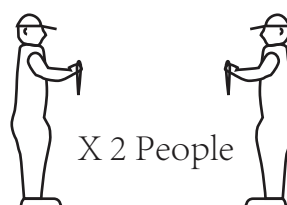

STEP 1 Trundle Bed x 1 pc

11	12	16	17
32 pcs	20 pcs	8 pcs	16 pcs

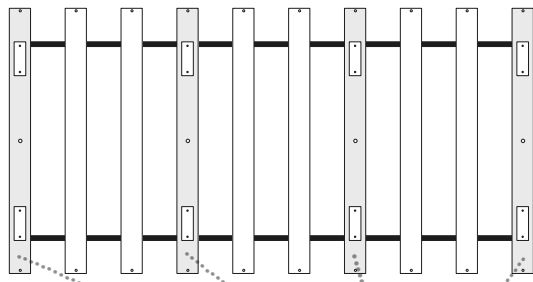

COMPLETED ASSEMBLY

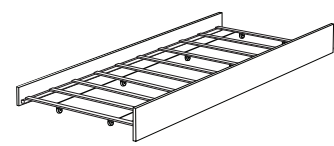

Step 1

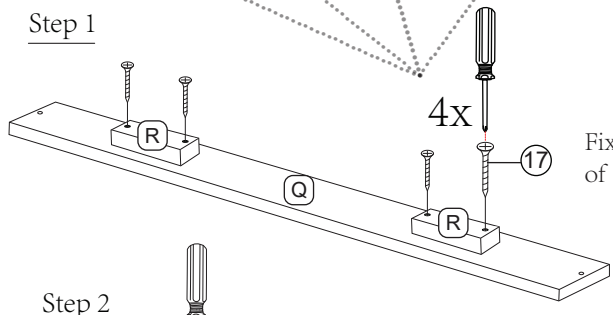

Fix the cube at the bottom of 1st, 4th, 7th, and 10th slat.

Step 2

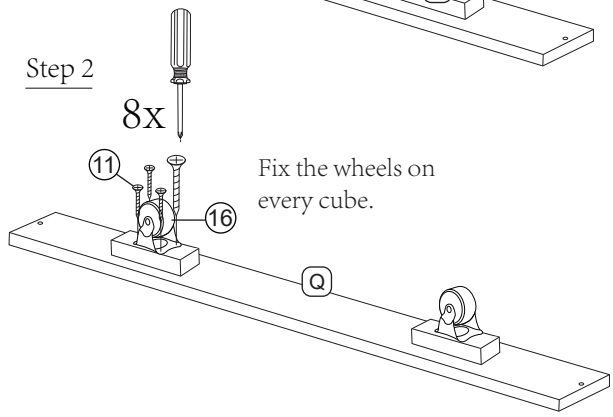

Fix the wheels on every cube.

Step 3

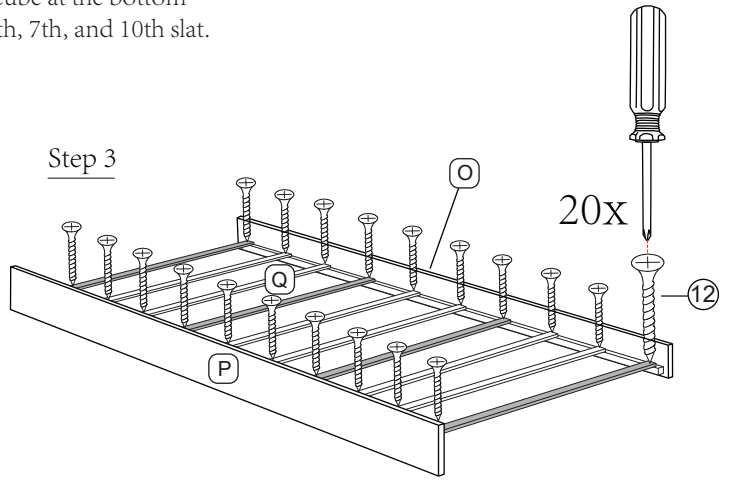

20x

STEP 2 Drawer x 2 pcs

20	11	15	16
8 pcs	24 pcs	16 pcs	8 pcs

Step 1

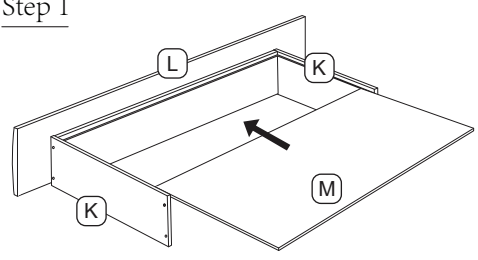

Step 2

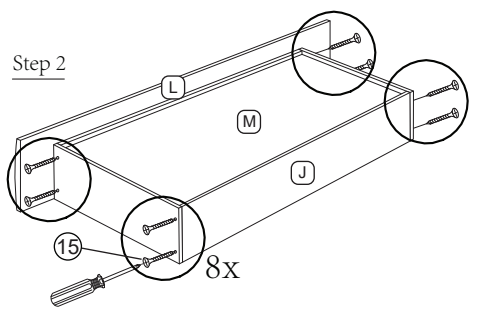

Step 3

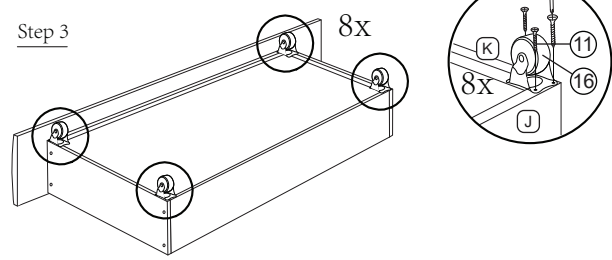



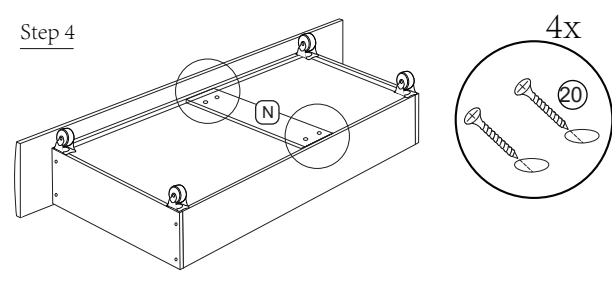

Step 4

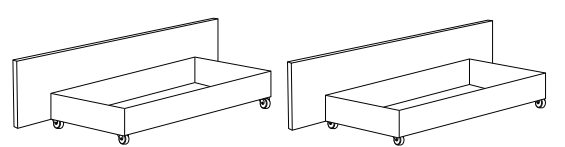

COMPLETED ASSEMBLY

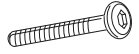

STEP 3

19	2	4	6	7
				
6 pcs	2 pcs	6 pcs	6 pcs	4 pcs

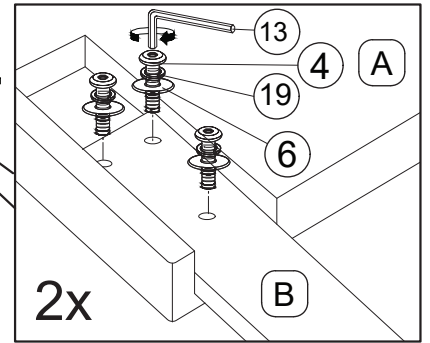
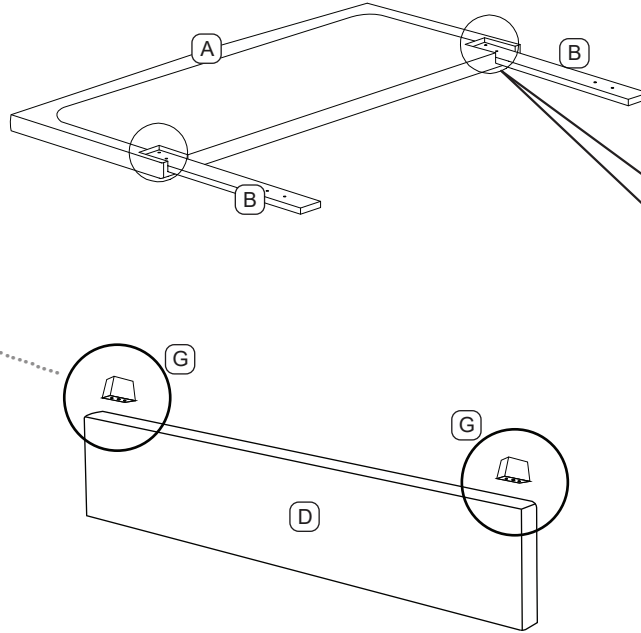
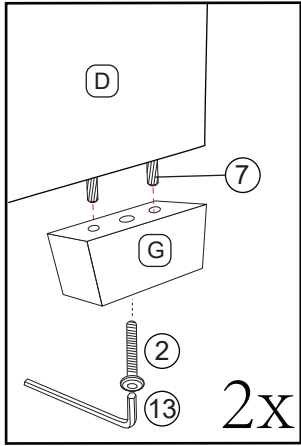

STEP 4

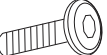
1

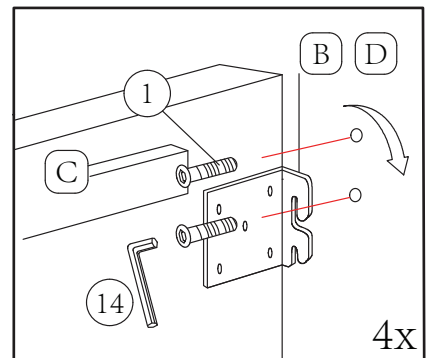
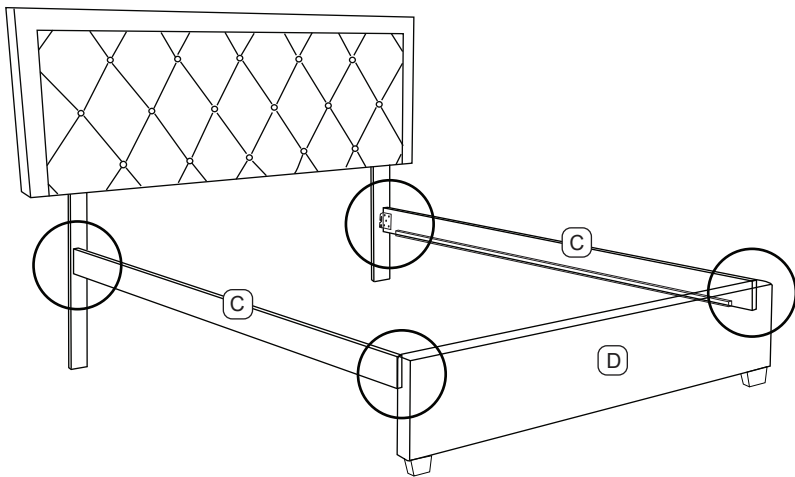
8 pcs



STEP 5

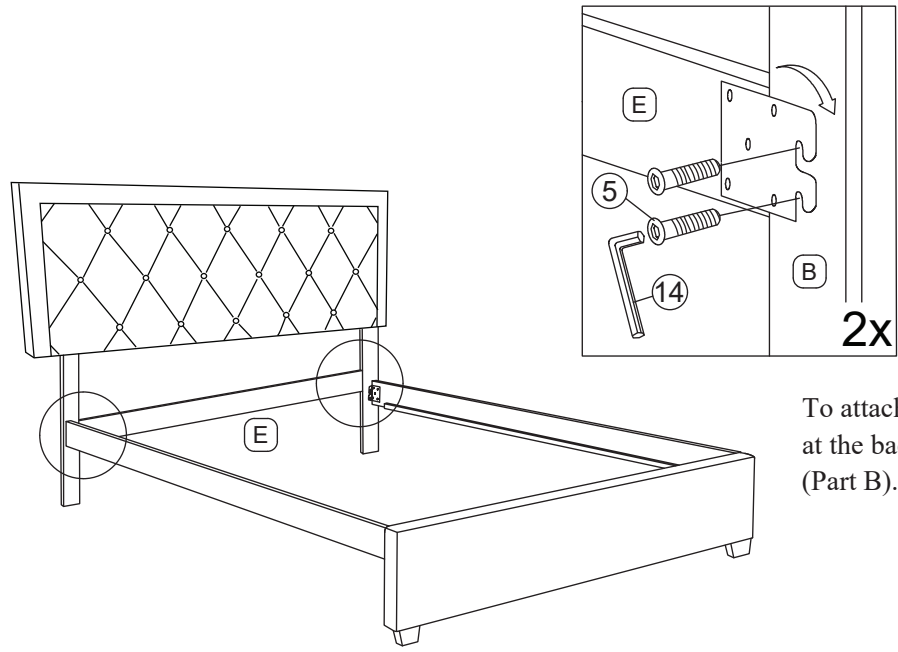



5

4 pcs

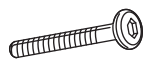

To attach the Headboard Support Bar at the backside to the Headboard Leg (Part B).

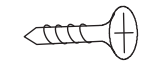
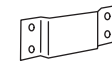
STEP 6

Decide the side for trundle bed & drawers

21	6	9	10	18
				
1 pc	1 pc	10 pcs	1 pc	6 pcs

Option 2

Option 1

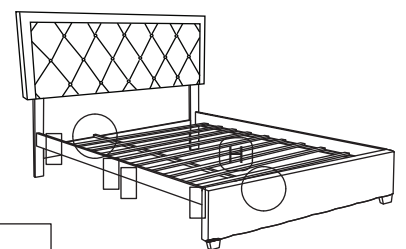
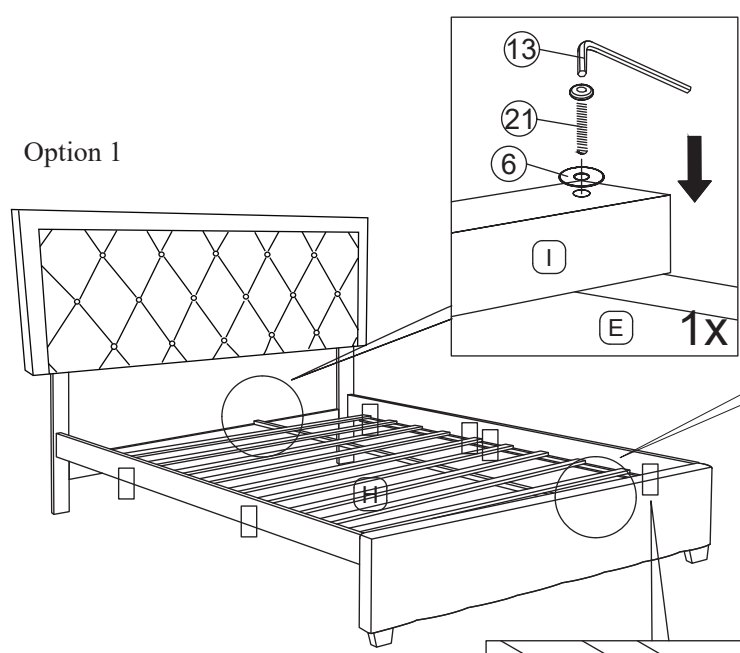

Follow the marking to attach the U-Bracket with Screw 20mm (4PCS) at Footboard.

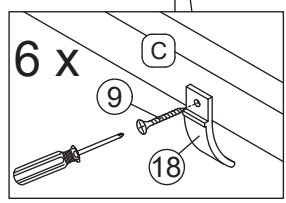

Optional:
Add drawer stopper

STEP 7

3	8	12
4 pcs	4 pcs	20 pcs

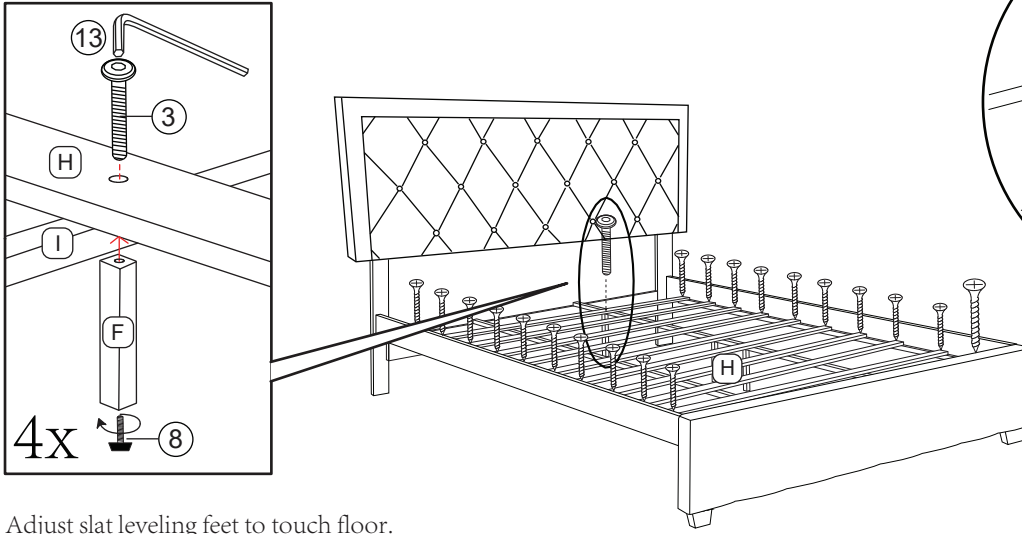

Adjust slat leveling feet to touch floor.

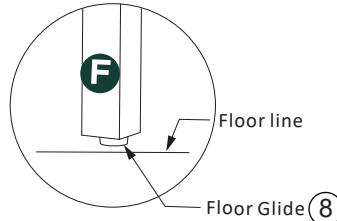

NOTE:

The center support leg glide recommended adjusted approximately 1/4" off of the floor. The glide will touch the floor after a mattress is placed on the bedframe.

Do not place a mattress on bedframe until it is fully assembled and the bedframe located in your desired location. Sliding the bed with weight upon it can compromise the integrity of the center support legs.

STEP 8

Connect the wire to the LED light.

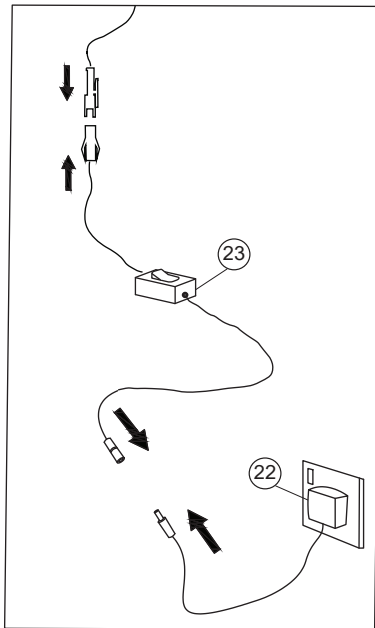

22	23
1 pc	1 pc

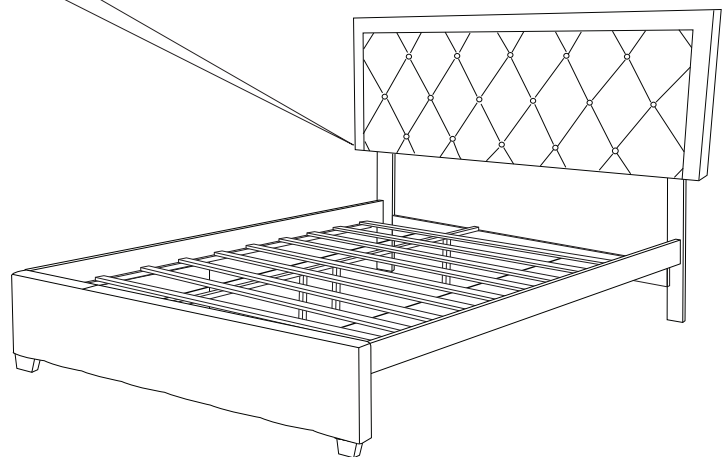

Lastly, place the trundle bed & drawers inside.

COMPLETED
ASSEMBLY

