

ASSEMBLY INSTRUCTION

SKU CODE: (WF312906-WF312907)

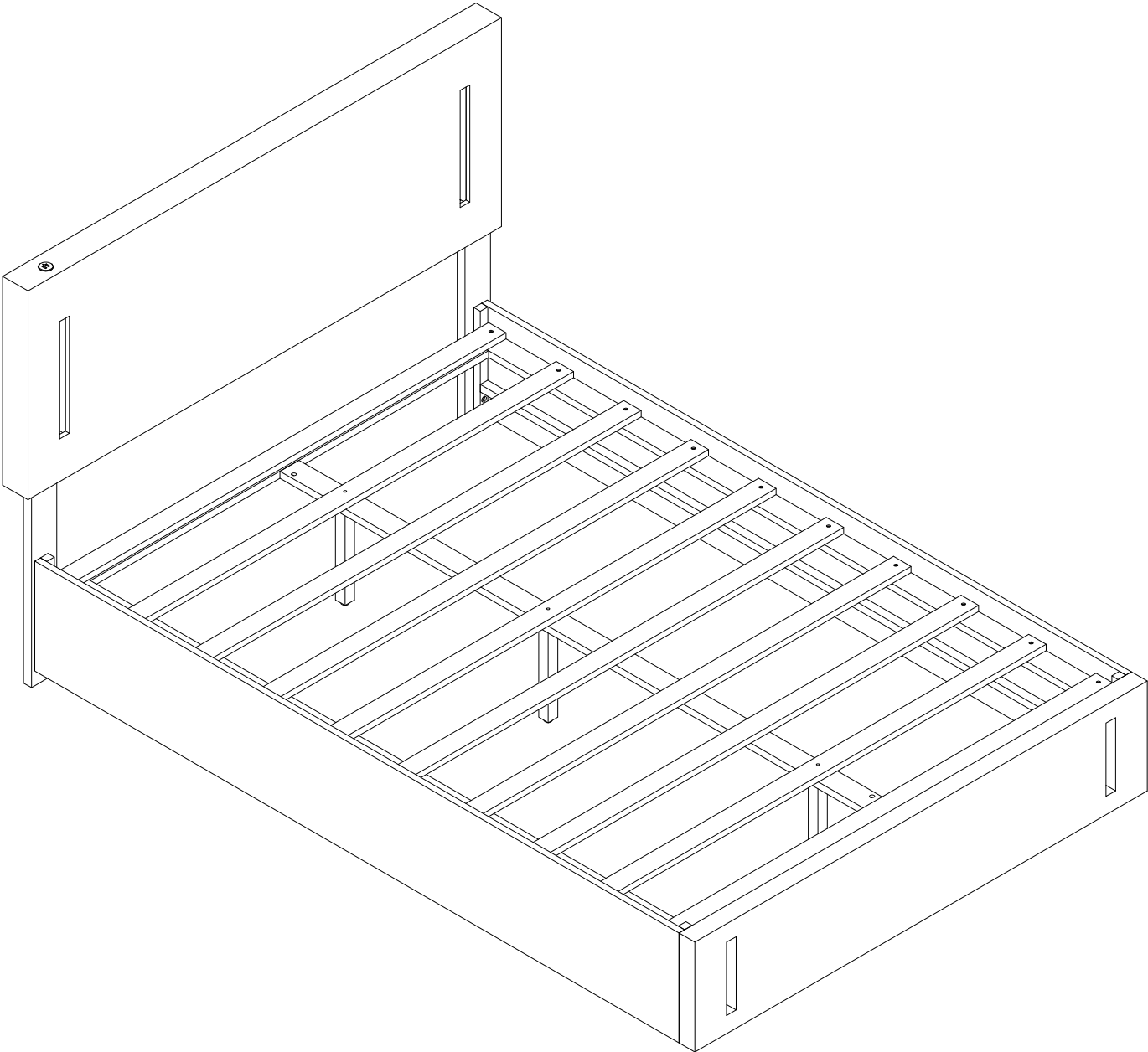

ASSEMBLY INSTRUCTION

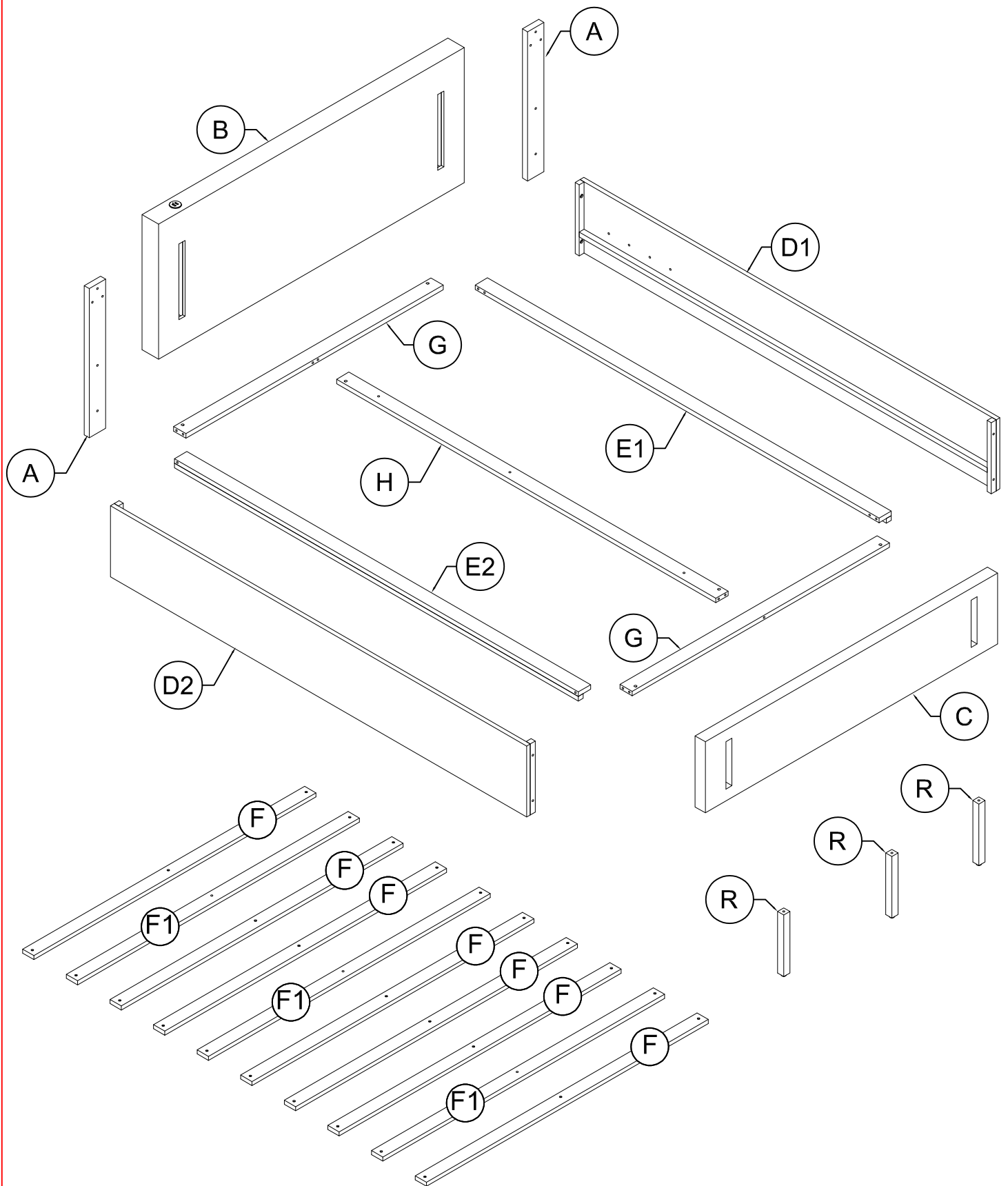

Part List (WF312906)

A

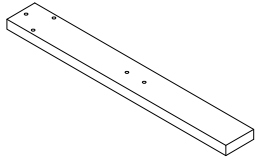

Leg - 2pcs

B

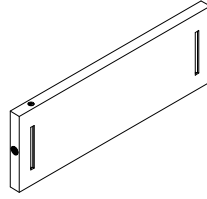

HB Frames - 1pc

C

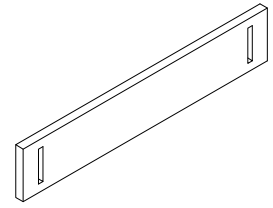

FB Frames - 1pc

F

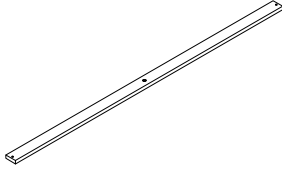

Slats - 7pcs

F1

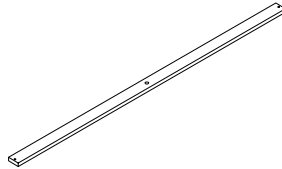

Slats - 3pcs

R



Support Leg - 3pcs

Hardware List (WF312906)

2

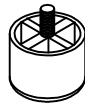

Plastic Feet(Ø50x40)
2pcs

3



Allen Key 1pcs

4

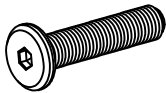

1/4" x 20mm
Hex-Head bolts 8pcs

5

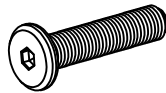

1/4" x 35mm
Hex-Head bolts 6pcs

6

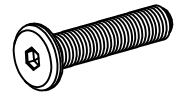

1/4" x 40mm
Hex-Head bolts 8pcs

7

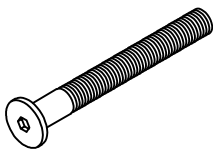

1/4" x 100mm
Hex-Head bolts 6pcs

8

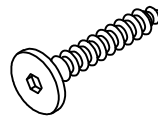

Screws 1/4" x 20mm
8pcs

9



1/4" x 15mm
Horizontal -Hole bolts 6pcs

10



M4 x 30 mm
Wood Screws 27pcs

11

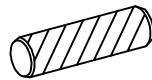

Ø8x30
Wood Dowel 6pcs

12

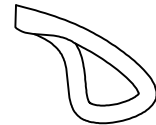

Pabric 1pc

13

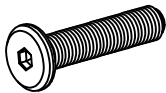

1/4" x 50mm
Hex-Head bolts 3pcs

14

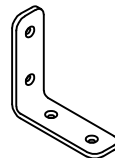

Steel Bracket
4pcs

15



M4 x 20 mm
Wood Screws 8pcs

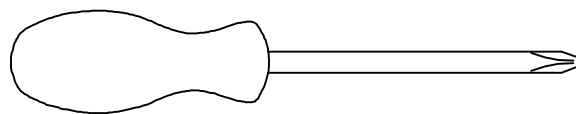

Assembly Tools Required (Not Included)

Part List (WF312907)

D1

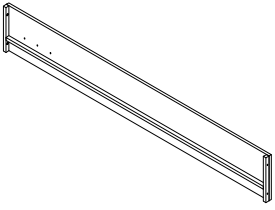

Side Rails Right - 1pc

D2

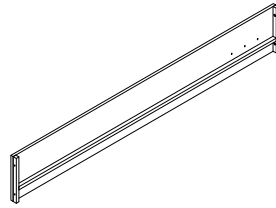

Side Rails Left- 1pc

E1

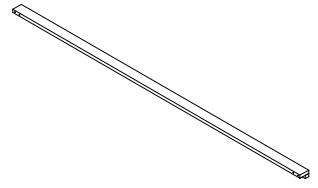

Side Bars Right - 1pcs

E2

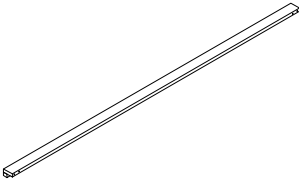

Side Bars Left - 1pcs

G

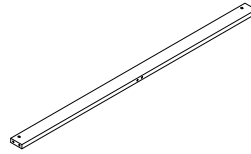

Bars - 2pcs

H

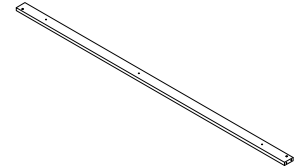

Support Slats - 1pc

1

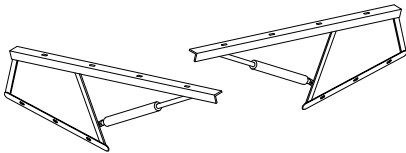

Piston (Left-Right) 1 set

STEP 1: Following below illustration:

2

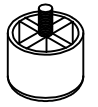

2pcs

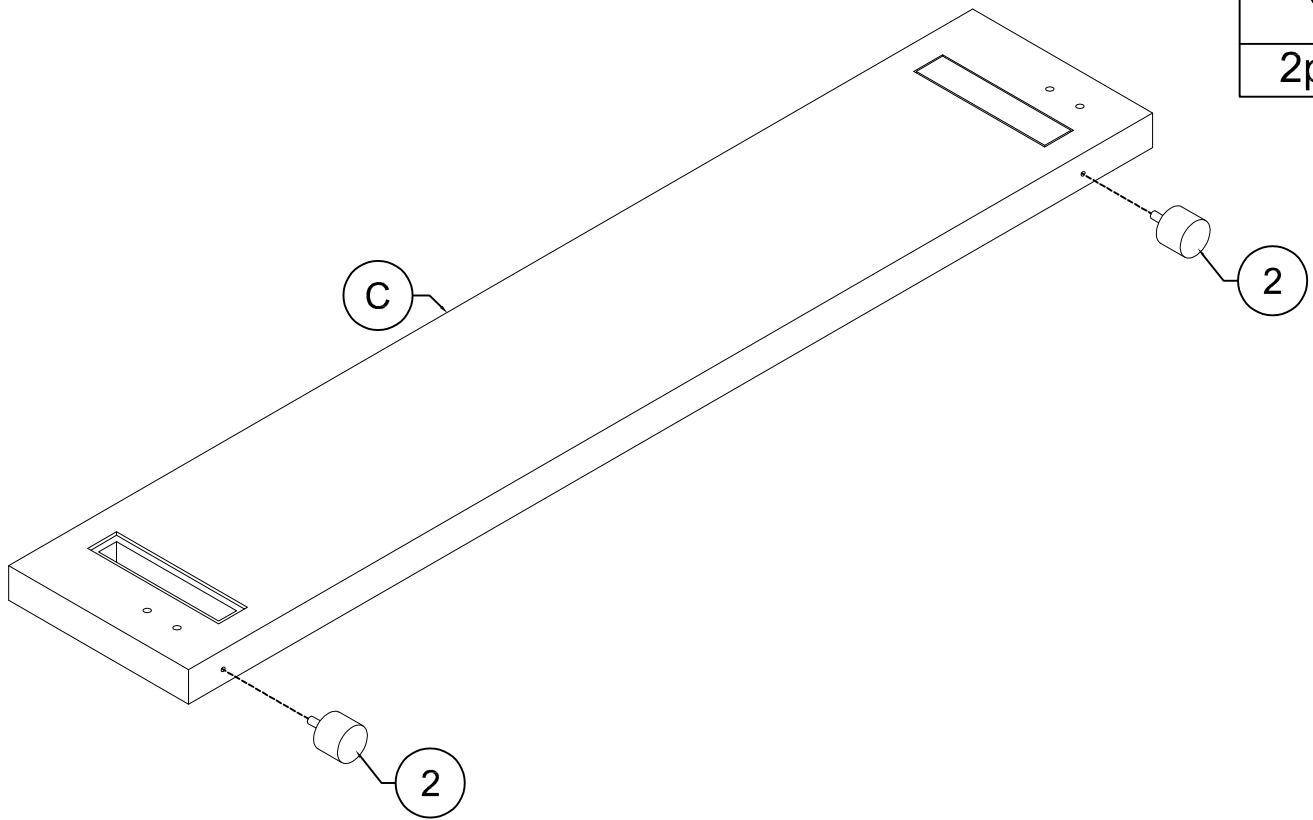

STEP 1-1: Following below illustration:

5



6pcs

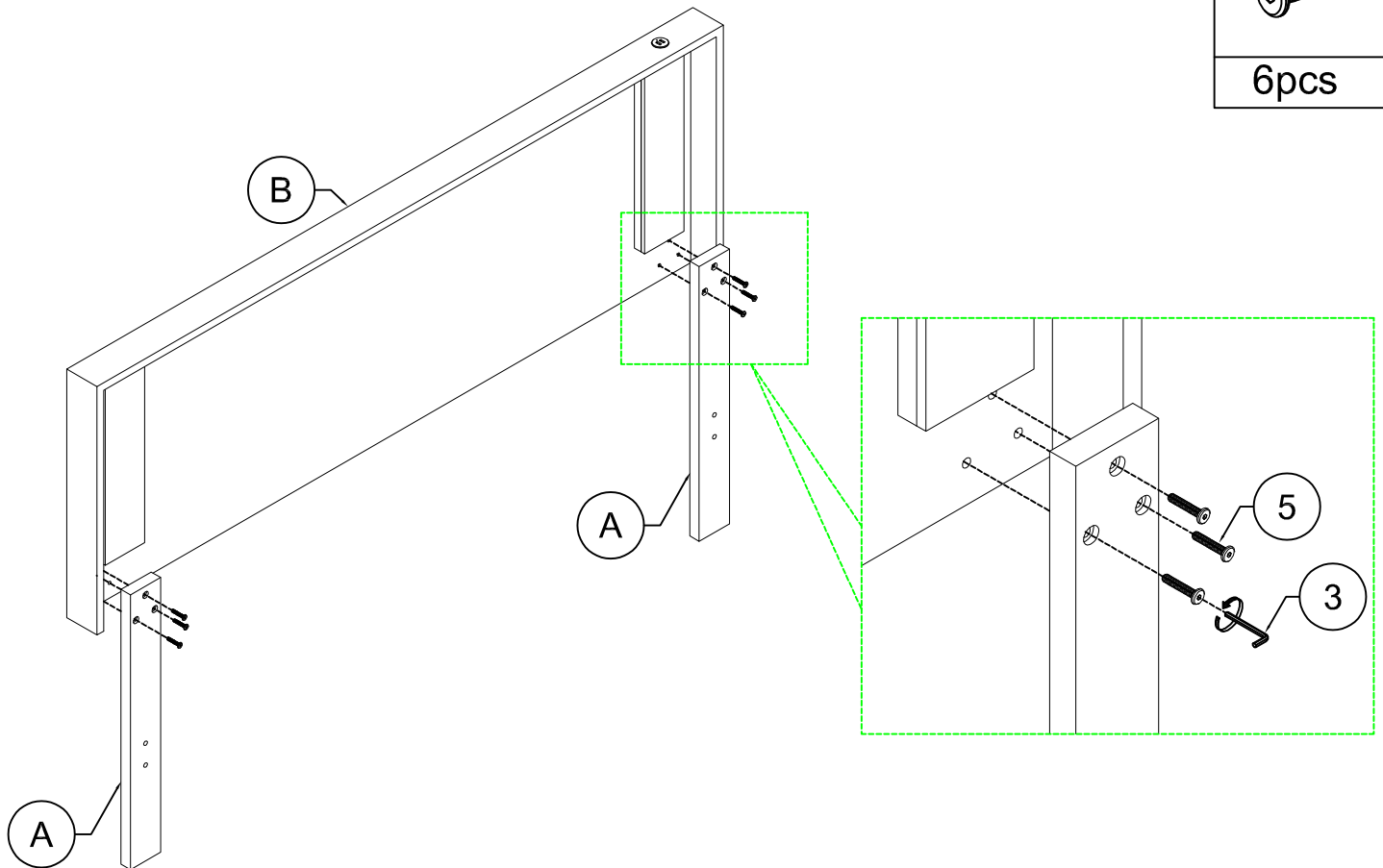



6

STEP 2: Following below illustration:

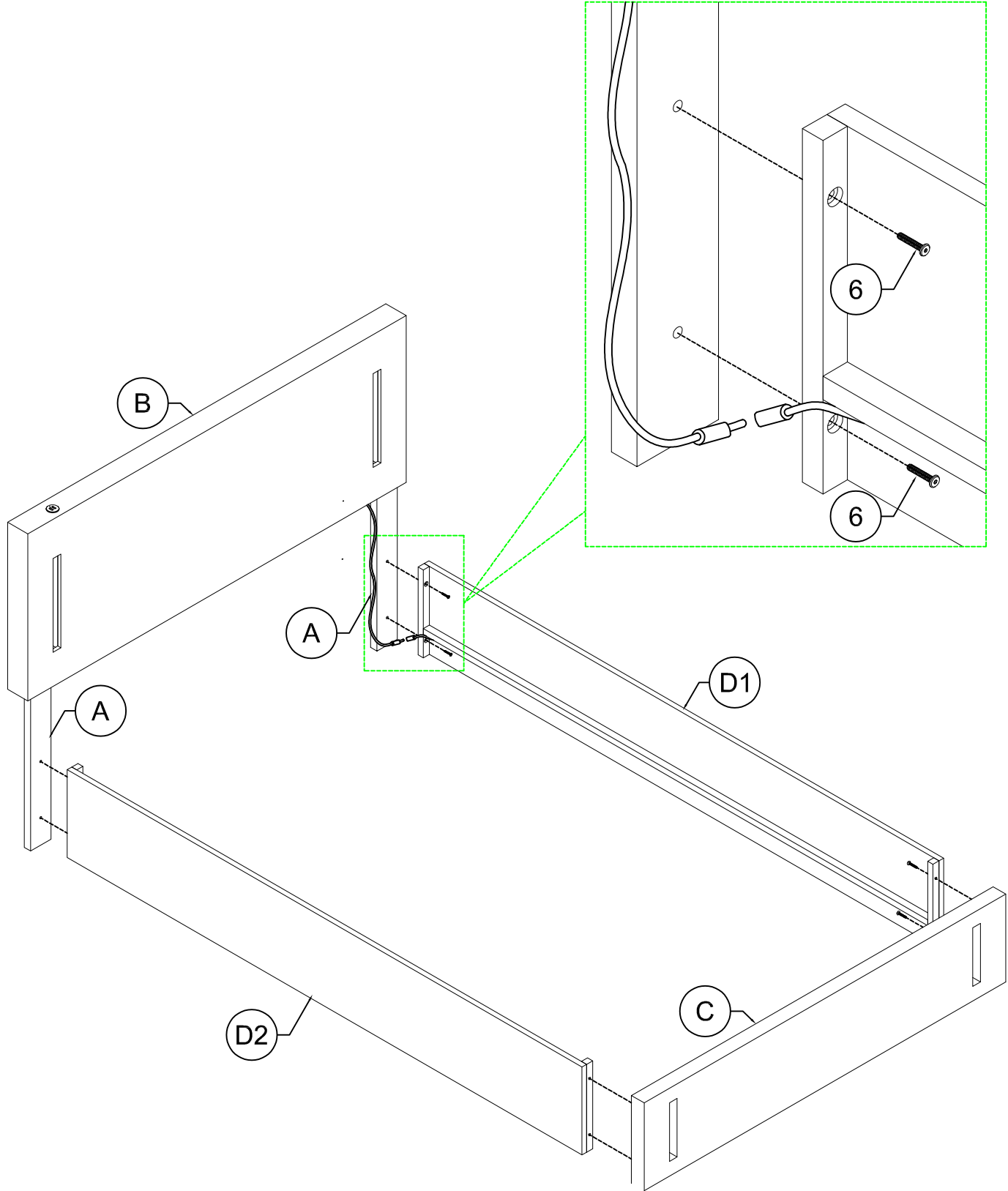
6

8pcs

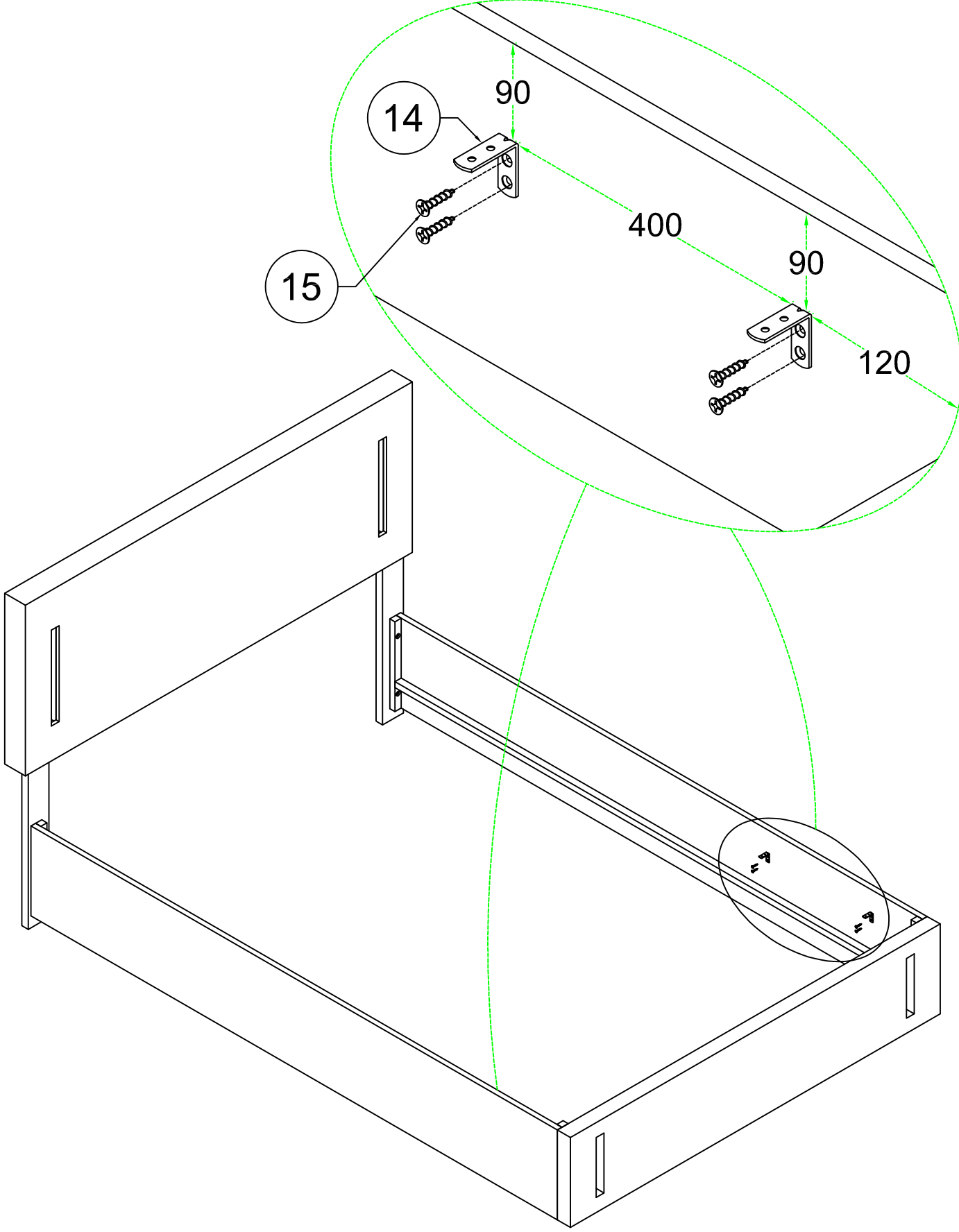

STEP 3: Following below illustration:

14		15	
4pcs		8pcs	



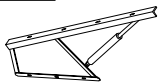
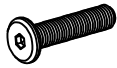

STEP 4: Following below illustration:

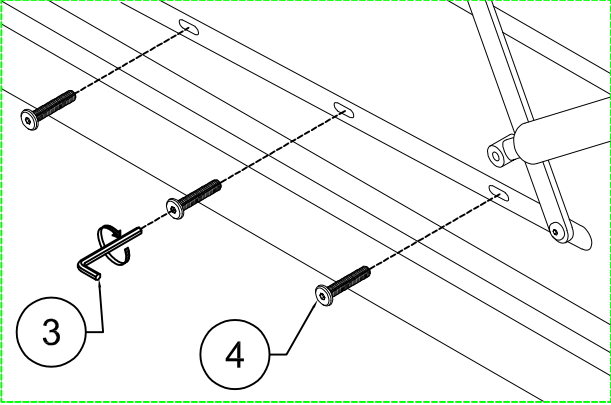
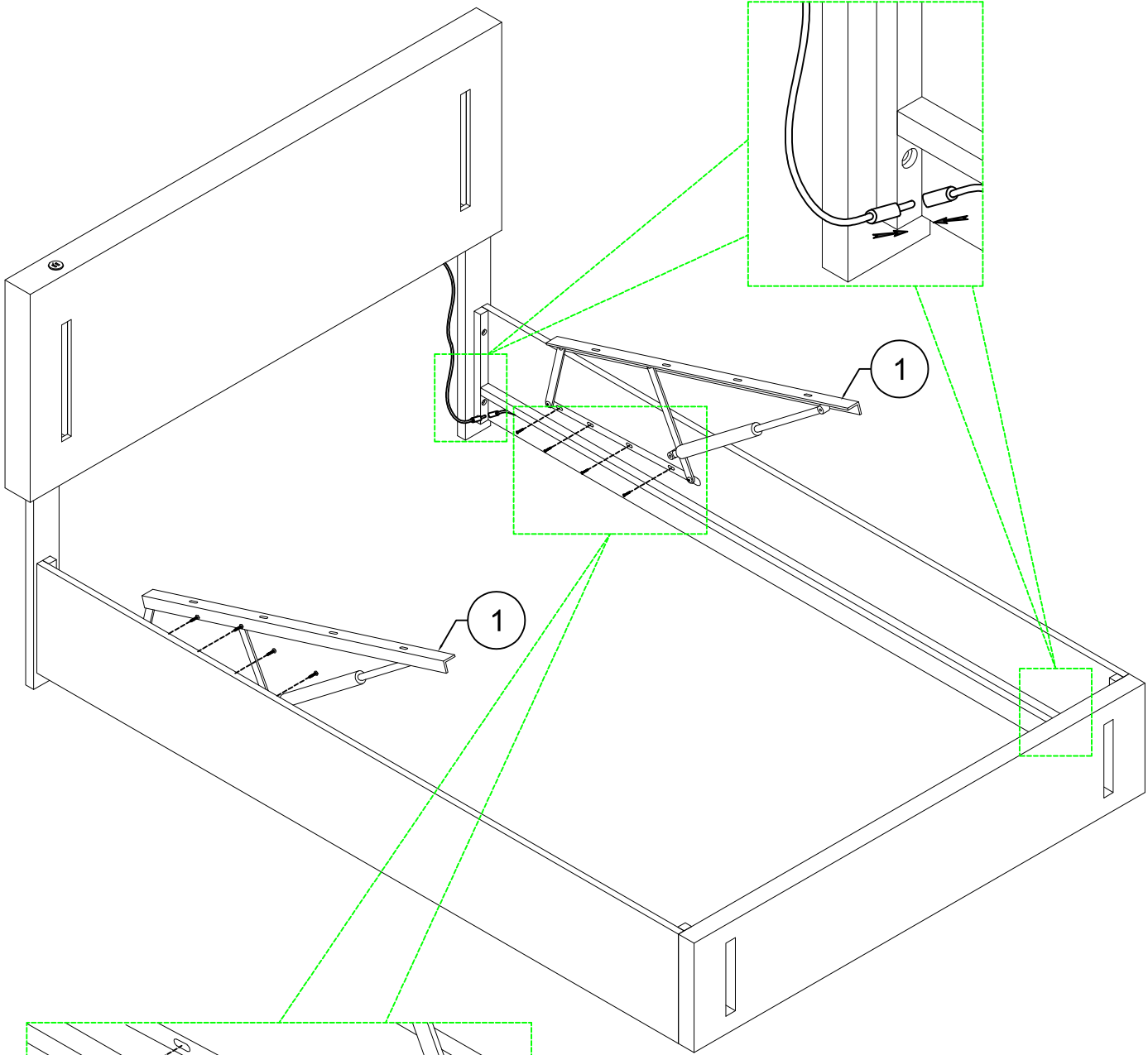
1	4
	
1 set	8pcs



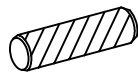

STEP 5: Following below illustration:

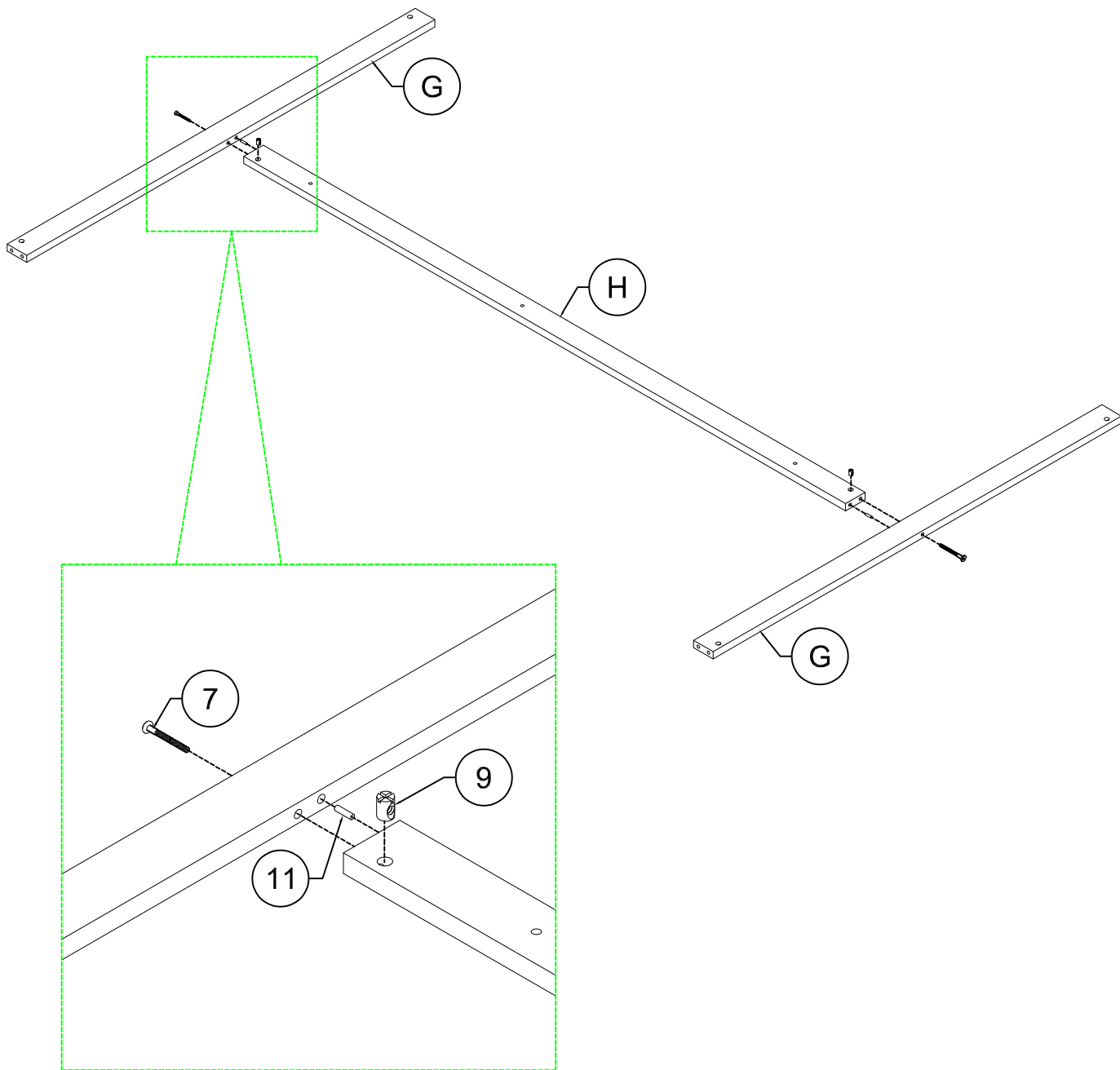
7	9	11
		
2pcs	2pcs	2pcs

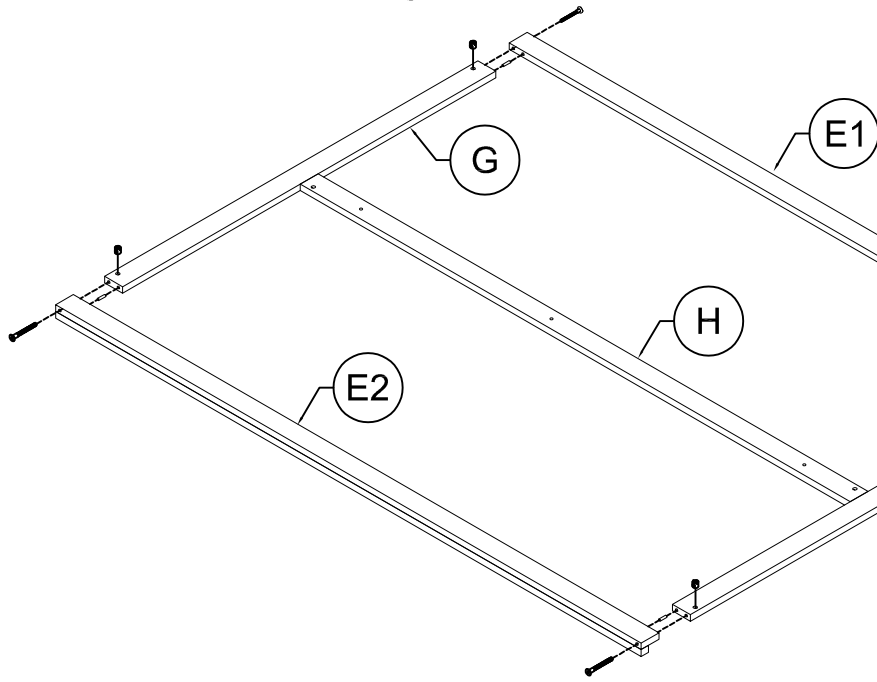

STEP 6: Following below illustration:

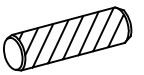

7	9	11
		
4pcs	4pcs	4pcs

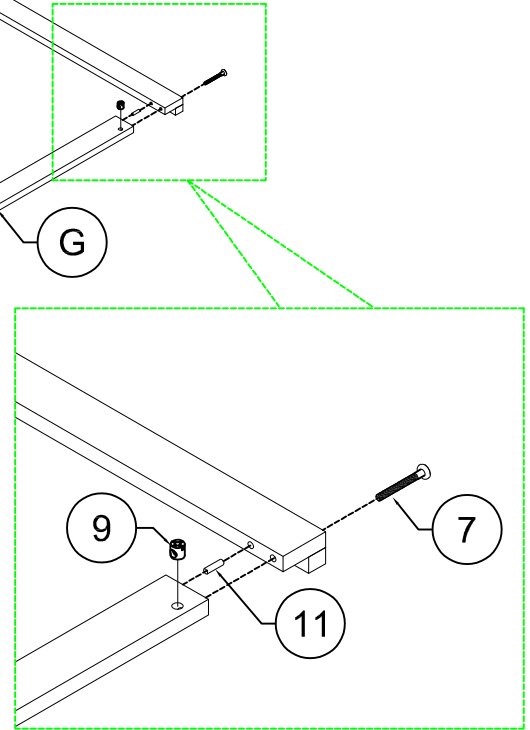

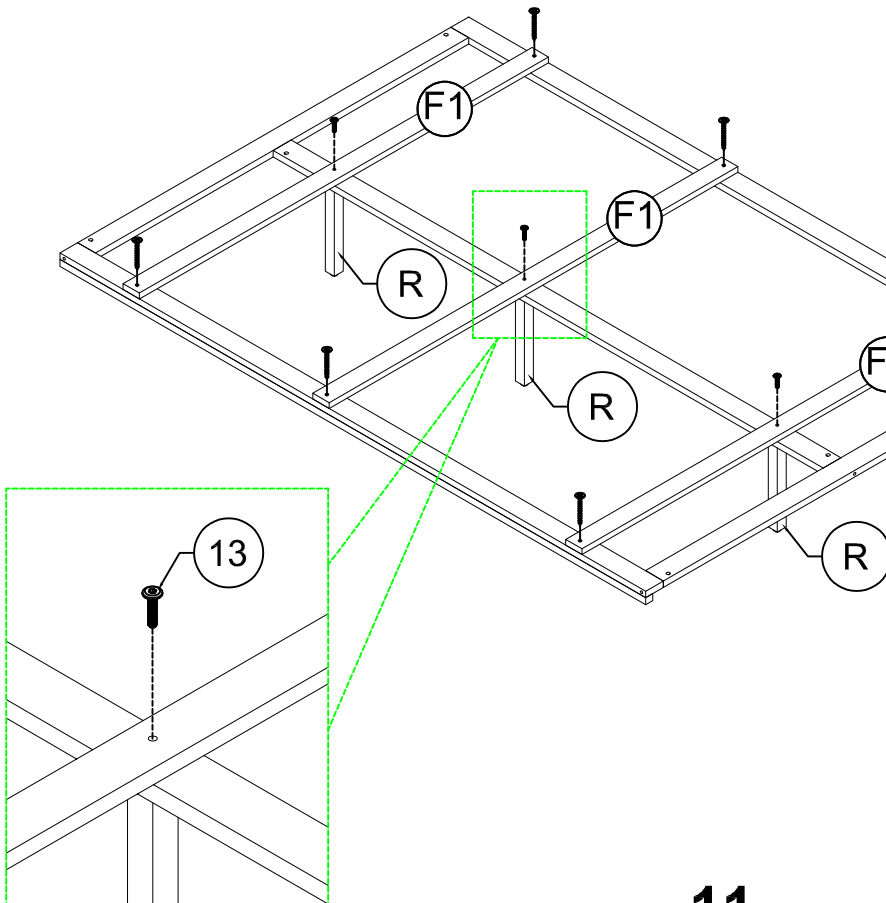

STEP 7: Following below illustration:

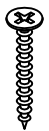

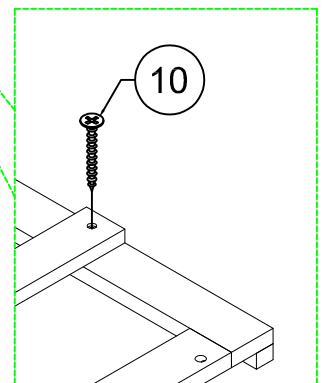
13	10
	
3pcs	6pcs

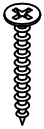

STEP 8: Following below illustration:

10		12	
21pcs		1pcs	

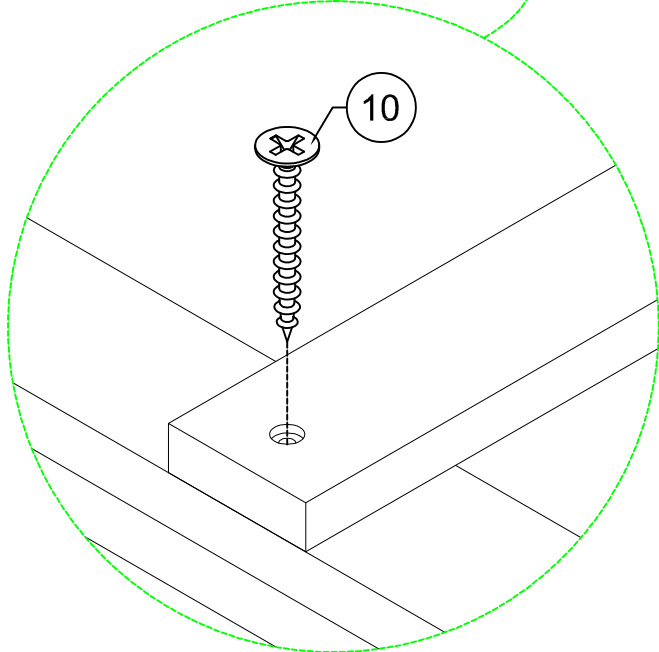
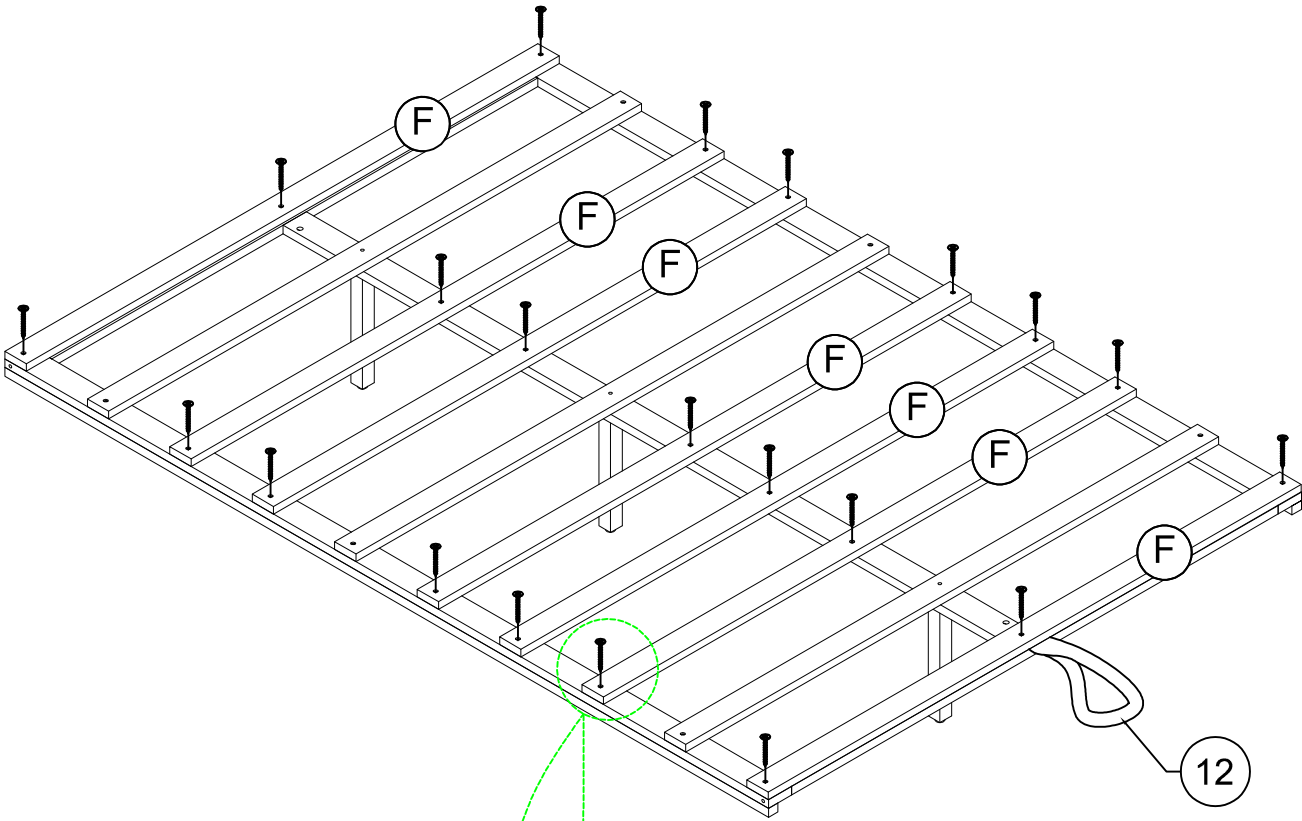

STEP 9: Following below illustration:

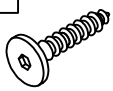
8

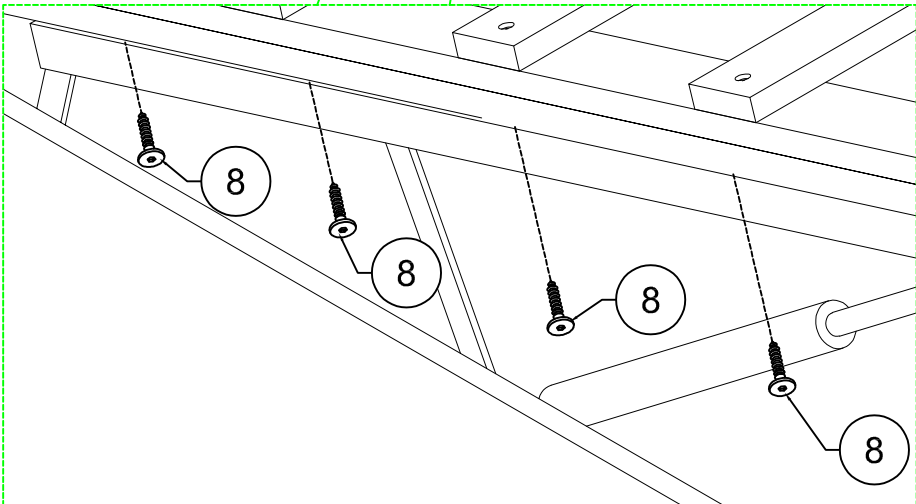
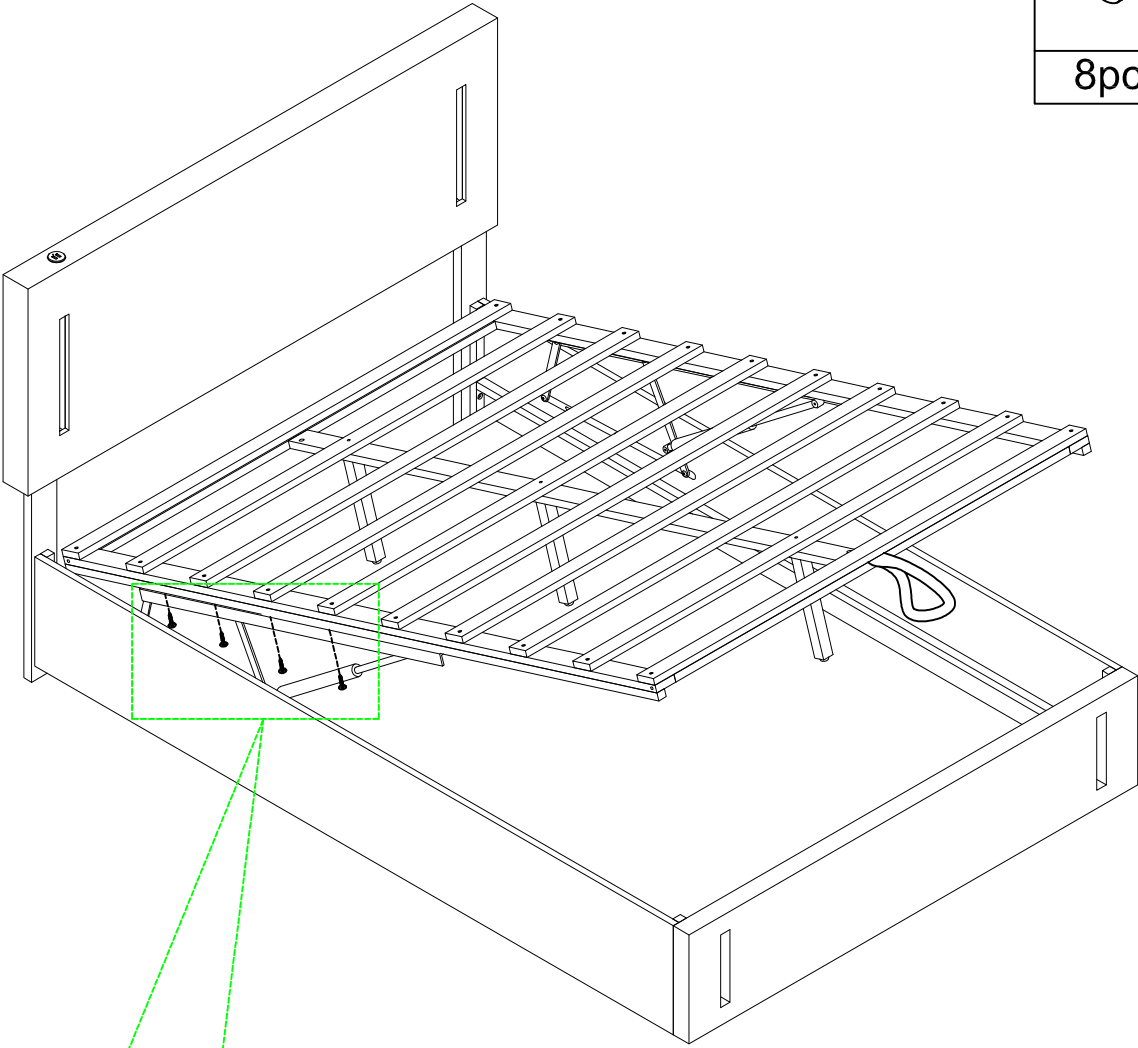
8pcs



FINISH

