

ASSEMBLY INSTRUCTION

MF308681 / MF308682

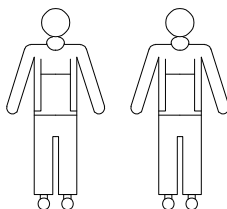

Minimum no. 2 of people
recommended to assemble
this product: Approx.
assembly time: 60 mins





SAFETY WARNING









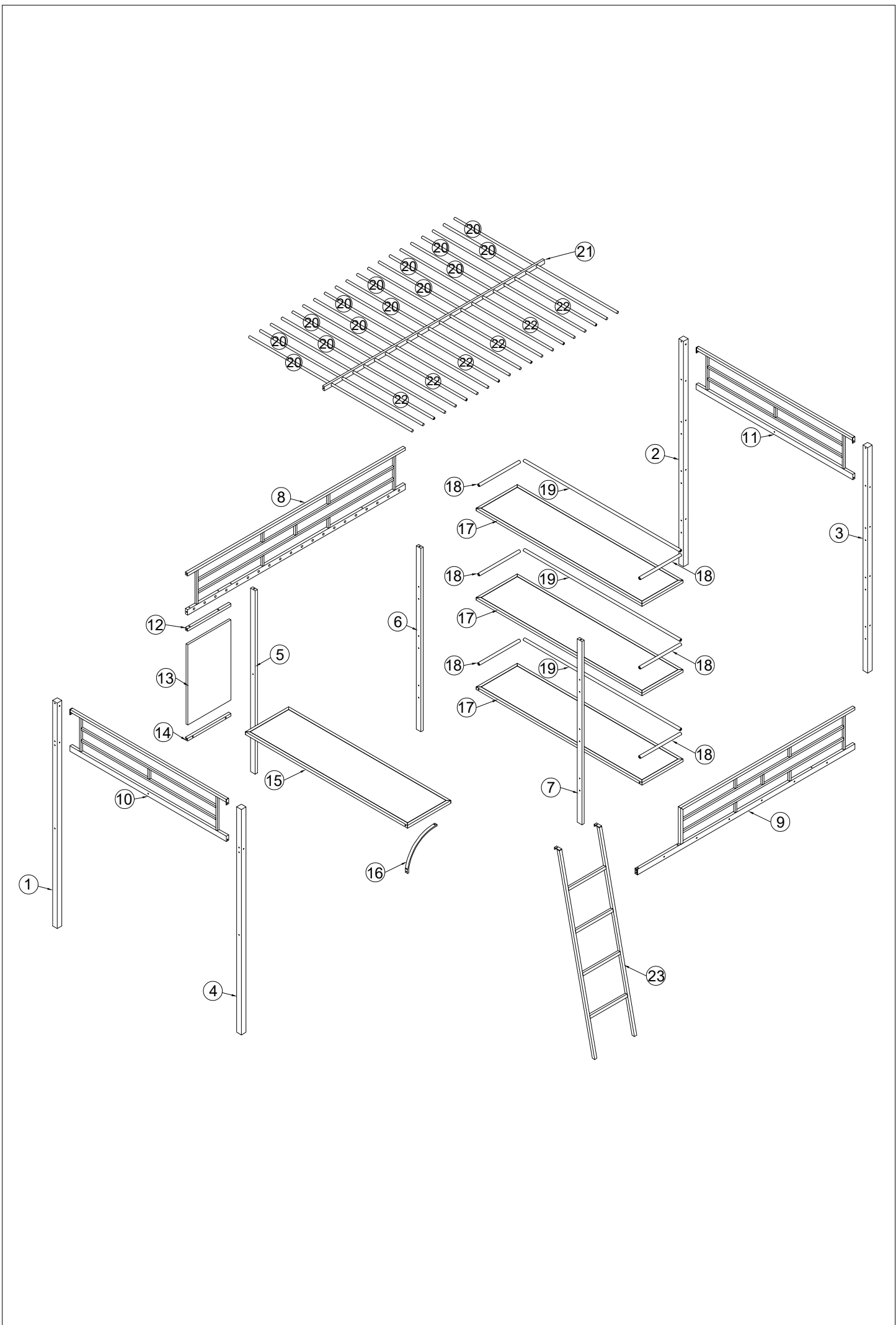



1. This bed is designed for use only mattress(es) meeting the following specifications on the upper bunk
Upper bunk

Bed type	Length	Width	Thickness
Twin Standard	74" - 75"	38.5"	6" Max



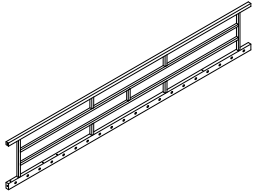
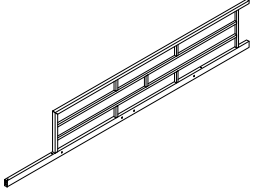
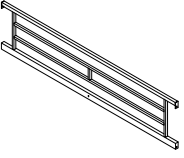



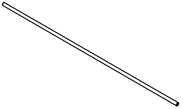
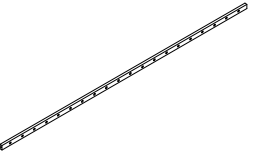
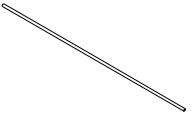
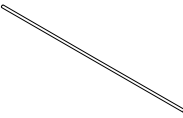
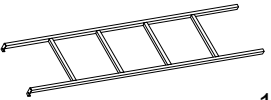

2. Replacement parts, including additional guardrails, maybe obtained from any for our (GIGACLOUD TECHNOLOGY(USA) INC.18961 ARENTH A VENUE CITY OF INDUSTRY, CA,91748) dealers
3. Follow the information on the warnings appearing on the upper bunk bed end structure and on the carton. Do not remove warning label from bed.
4. Always use the recommended size mattresses or mattress supports, or both, to help prevent the likelihood of entrapment or falls.
5. Surface of mattress must be at least 5"(127mm) below the upper edge of guardrails .
6. Do not allow children under 6 years of age to use the upper bunk.
7. Periodically check and ensure that the guardrail , ladder , and other components are in their proper position , free from damage , and that all connectors are tight .
8. Do not allow horseplay on or under the bed and prohibit Jumping on the bed .
9. Always use the ladder for entering and leaving the upper bunk .
10. Do not use substitute part . Contact the manufacturer or dealer for replacement part .
11. Use of a night light may provide added safety precaution for a child using the upper bunk .
12. Always use guardrails on both long sides of upper bunk . if the bunk bed will be placed next to the wall , the guardrail that runs the full length of the bed should be placed against the wall to prevent entrapment between the bed and wall .
13. The use of water or sleep flotation mattresses is prohibited .
14. **STRANGULATION HAZARD** - Never attach or hang items to any part of the bunk bed that are not designed for use with the bed ; for example , but not limited to , hook , belts and Jump ropes .
15. Keep these instruction for future reference .
16. Prohibit more than one person on upper bunk
17. We recommend assembling your bunk bed on the shipping carton to protect your floor or carpet
18. Be certain all staples are out the box before beginning assembly on the shipping carton .





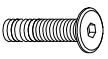

PART LIST MF308681

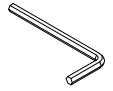
1		1PC	2		1PC	3		1PC
4		1PC	5		1PC	6		1PC
7		1PC	8		1PC	9		1PC
10		1PC	12		1PC	14		1PC
16		1PC	19		3PCS	21		1PC
20		14PCS	22		6PCS	23		1PC

HARDWARE LIST MF308681

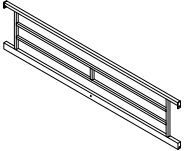

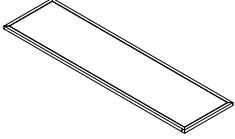
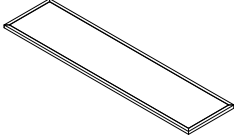
A		37 PCS M $\frac{1}{4}$ "X50	B		17 PCS M $\frac{1}{4}$ "X35	C		2 PCS M $\frac{1}{4}$ "X30	D		1 PC M $\frac{1}{4}$ "X25	E		18 PCS M $\frac{1}{4}$ "X15
F		4 PCS #40x40x16	G		2PCS #20x20x13	H		3PCS #20x40x13	i		4PCS M4x15	J		1PC M4X23X57

PART LIST MF308682

<p>11</p>  <p>1PC</p>	<p>13</p>  <p>1PC</p>	<p>15</p>  <p>1PC</p>
<p>17</p>  <p>3PCS</p>	<p>18</p>  <p>6PCS</p>	

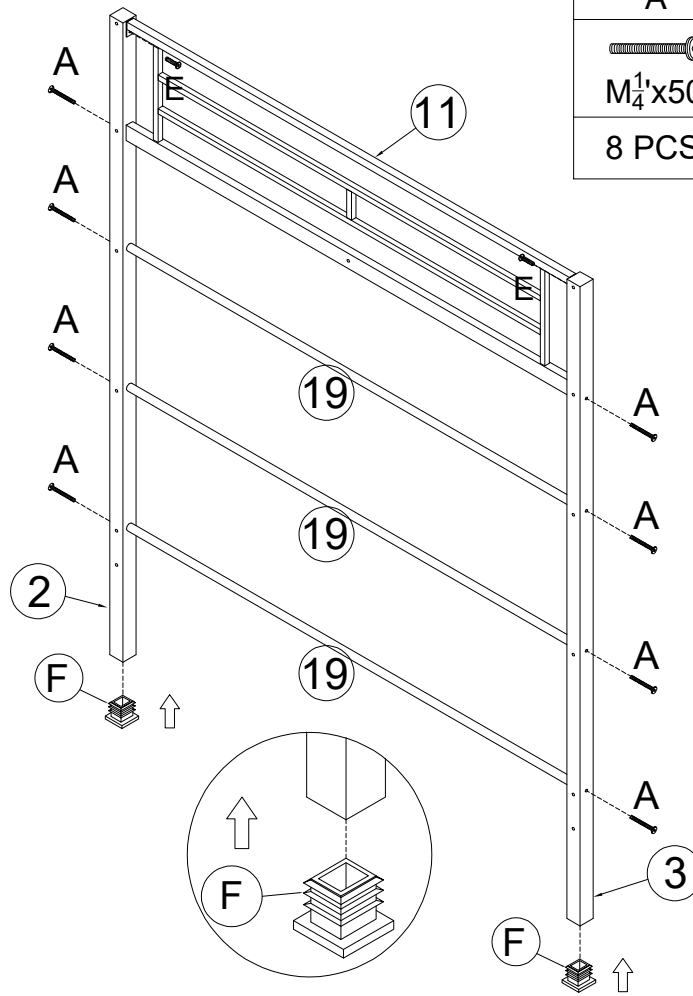
STEP 1



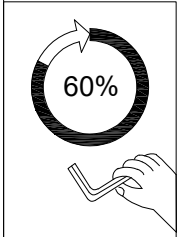

A	E	F
 M $\frac{1}{4}$ "x50	 M $\frac{1}{4}$ "x15	 #40x40x16
8 PCS	2 PCS	2PCS

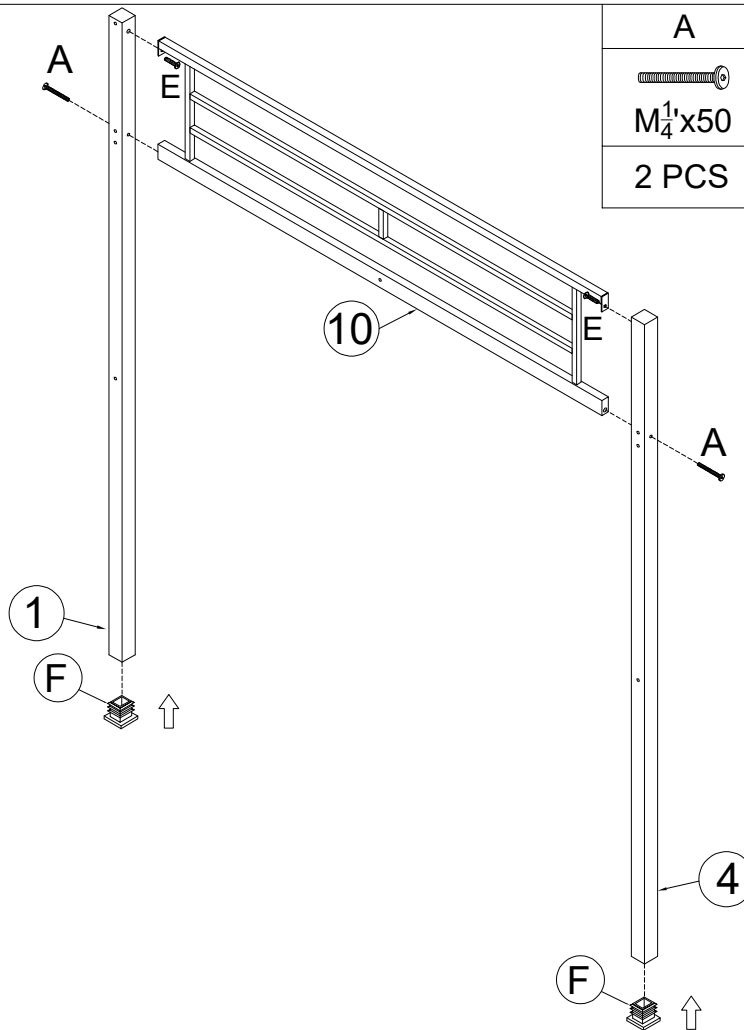

STEP 2



A	E	F
 M $\frac{1}{4}$ "x50	 M $\frac{1}{4}$ "x15	 #40x40x16
2 PCS	2 PCS	2PCS

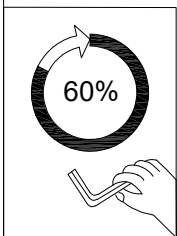

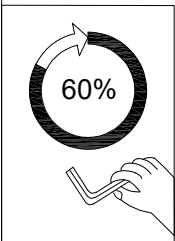
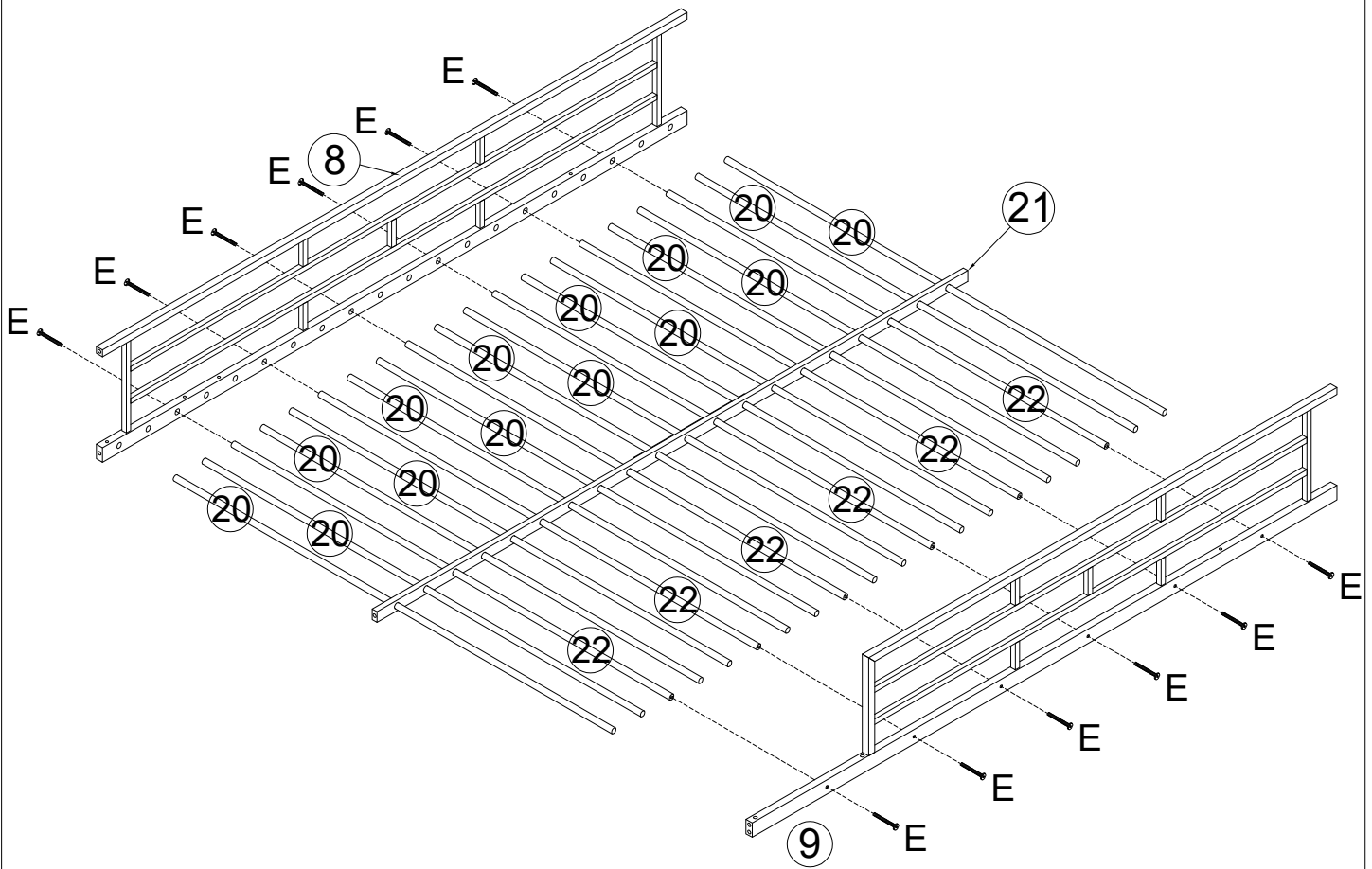

STEP 3

E
 M $\frac{1}{4}$ "x15
12 PCS



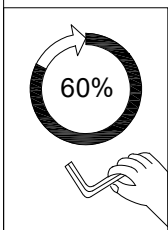
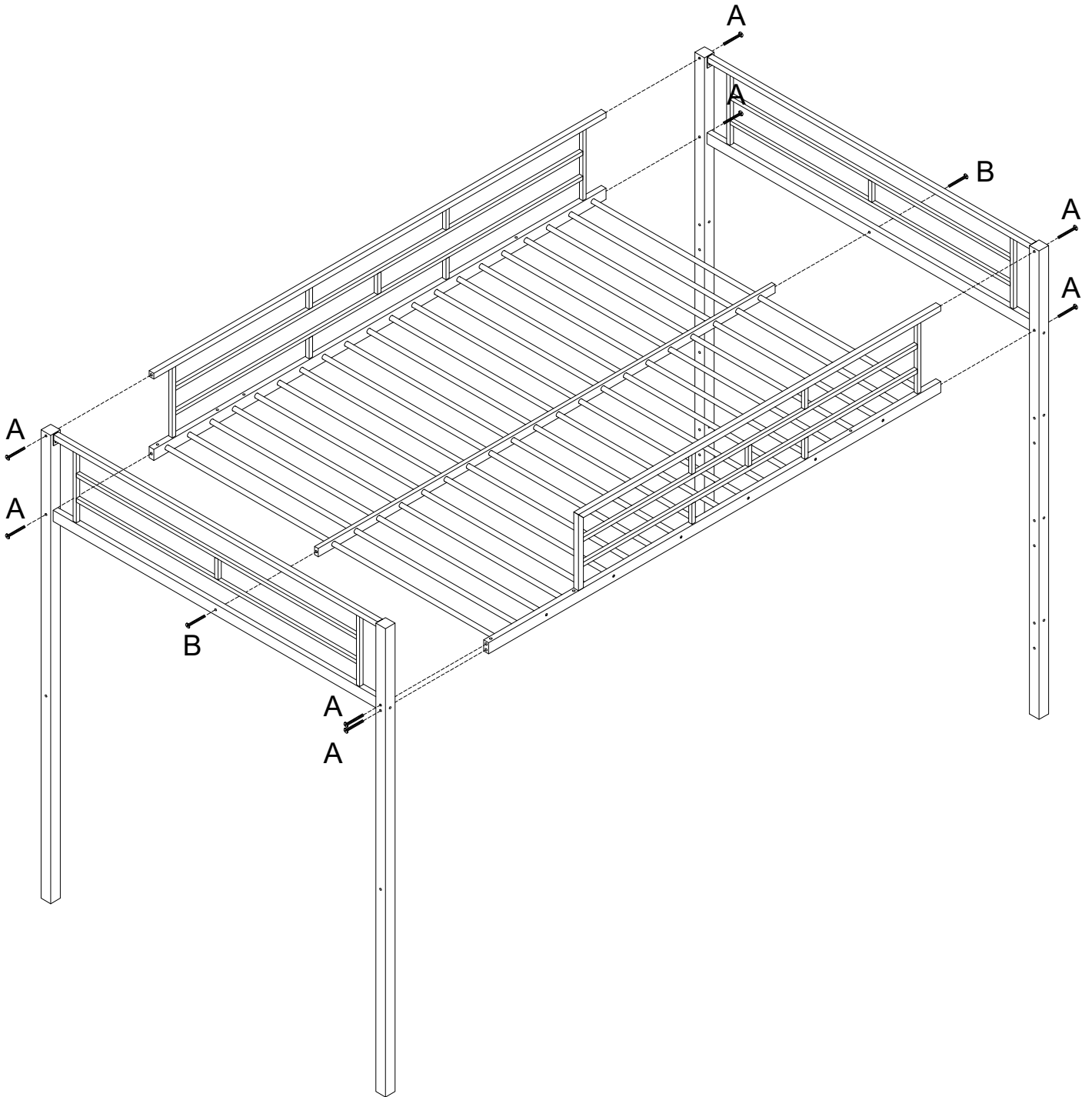

STEP 4

A	B
 M $\frac{1}{4}$ "x50	 M $\frac{1}{4}$ "x35
8 PCS	2 PCS



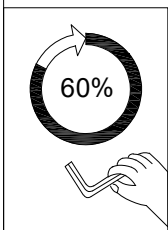
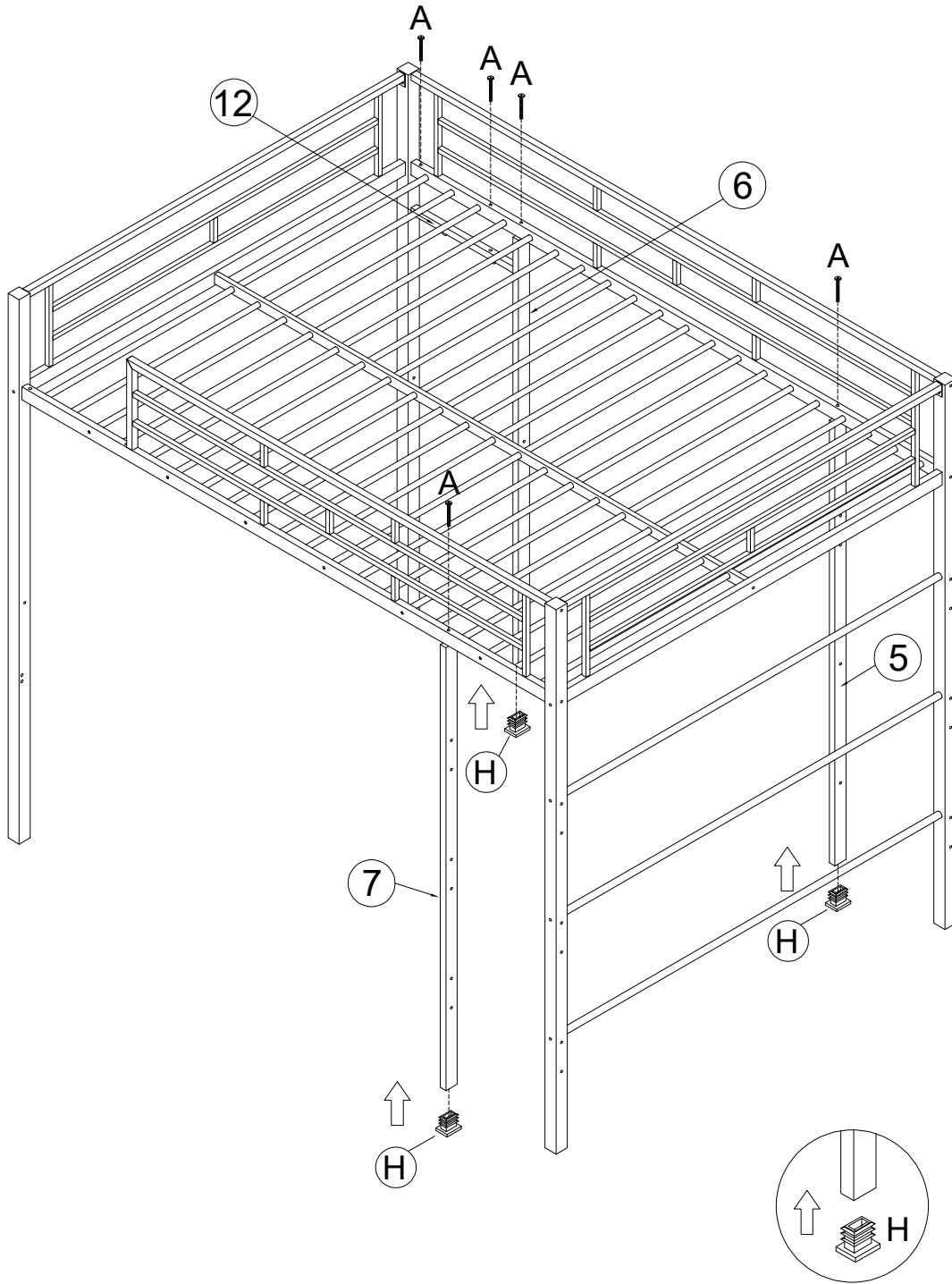

STEP 5

A	H
 M $\frac{1}{4}$ "x50	 #20x40x13
5 PCS	3PCS



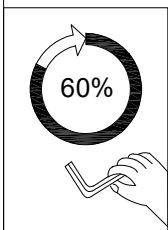
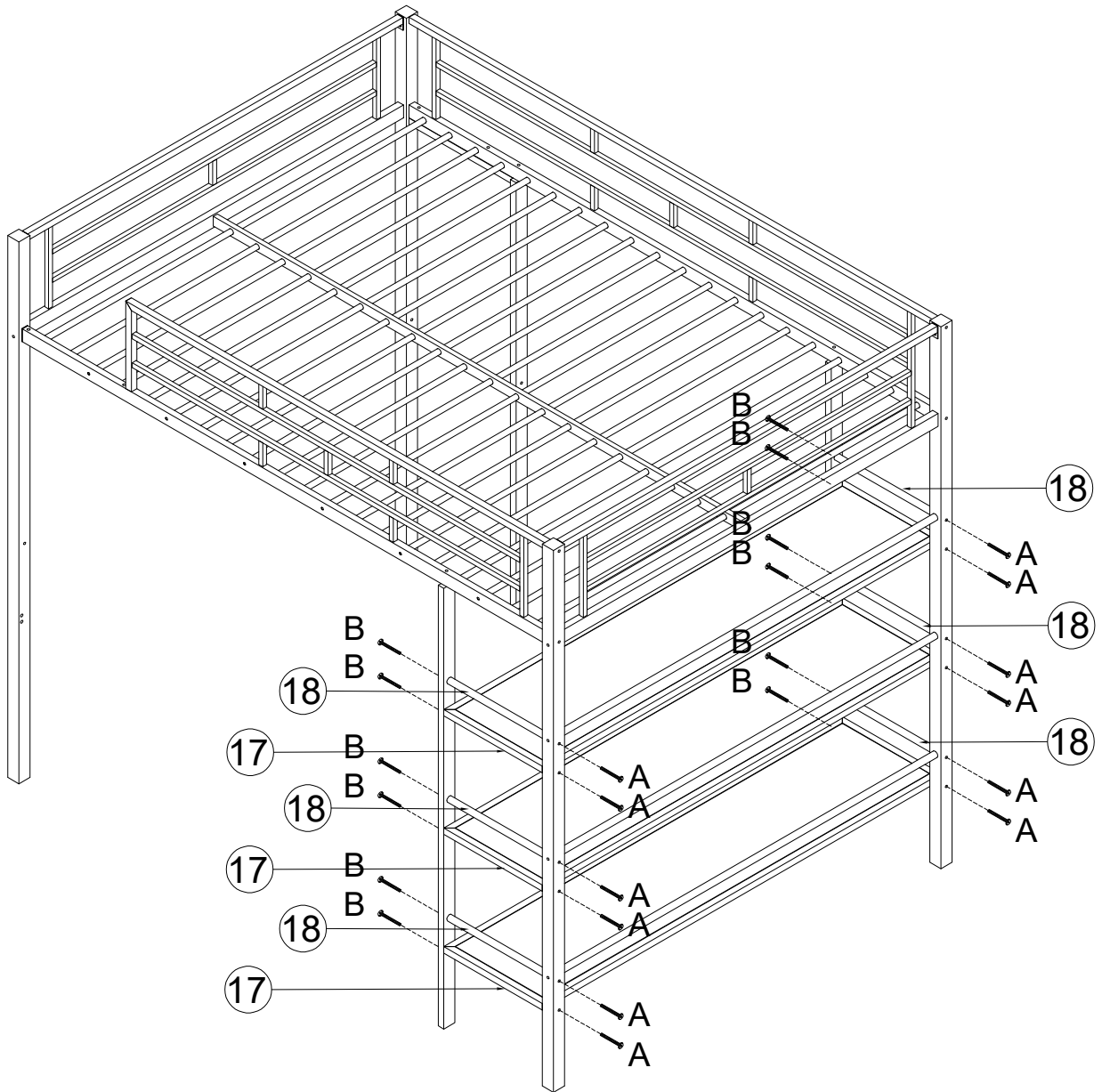

STEP 6

A	B
 M $\frac{1}{4}$ "x50	 M $\frac{1}{4}$ "x35
12 PCS	12 PCS



STEP 7

A	B	i
 M $\frac{1}{4}$ "x50	 M $\frac{1}{4}$ "x35	 M4x15
1 PC	1 PC	4 PCS

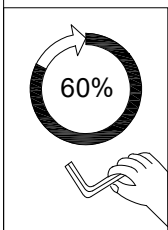
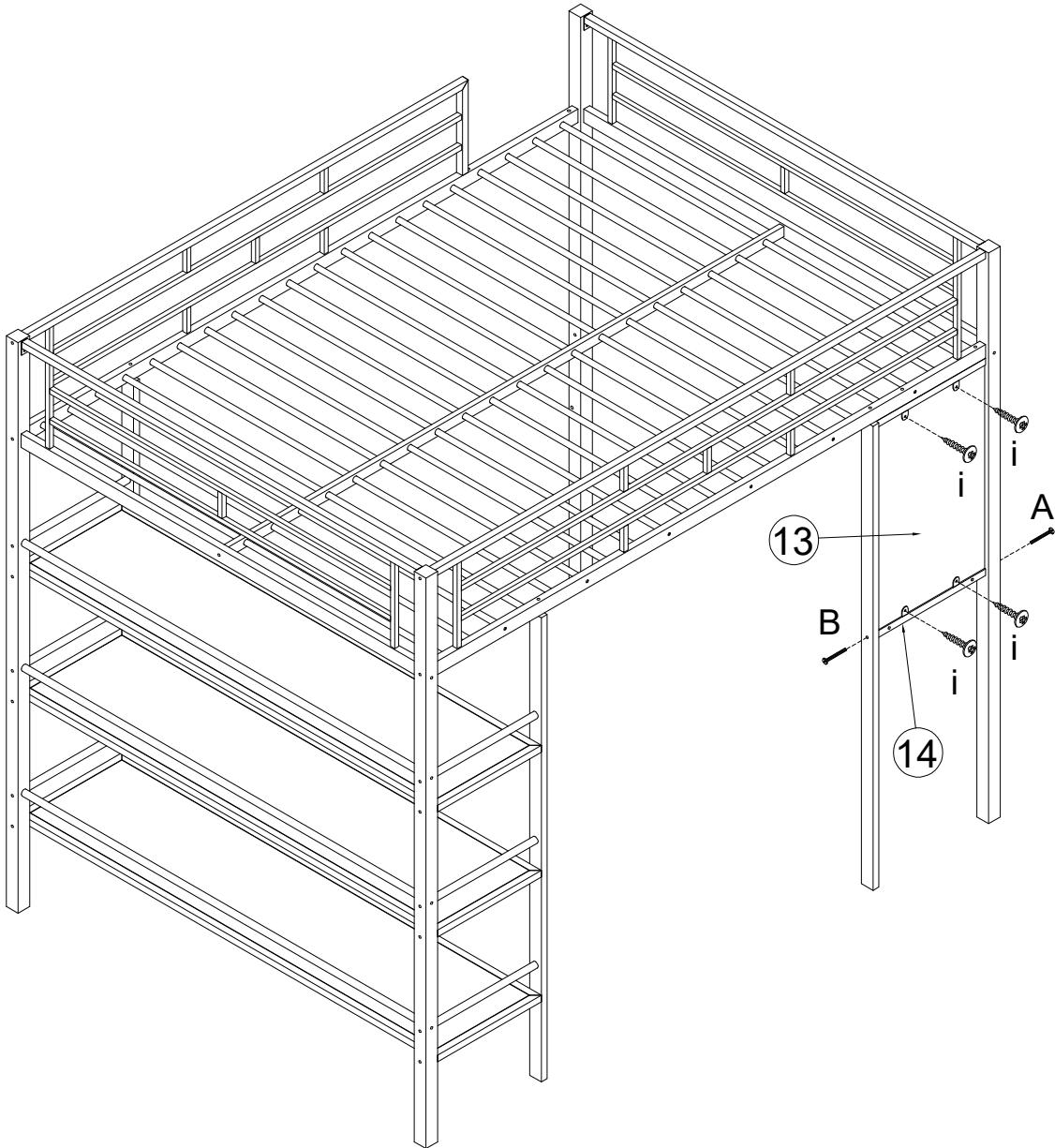

STEP 8



C

M $\frac{1}{4}$ "x30

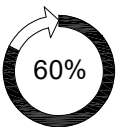
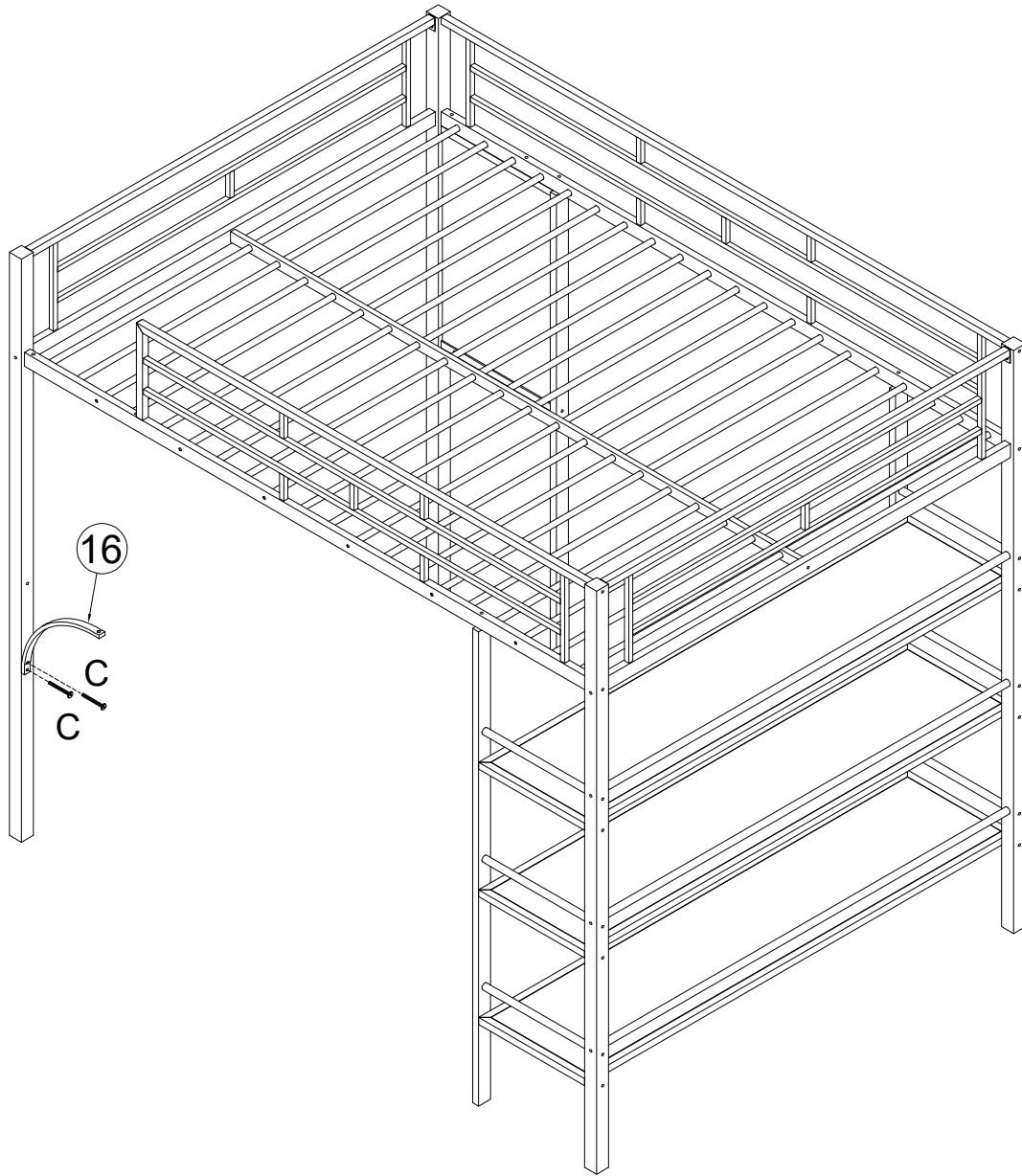
2 PCS



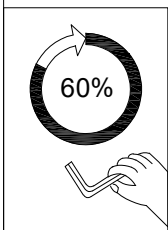
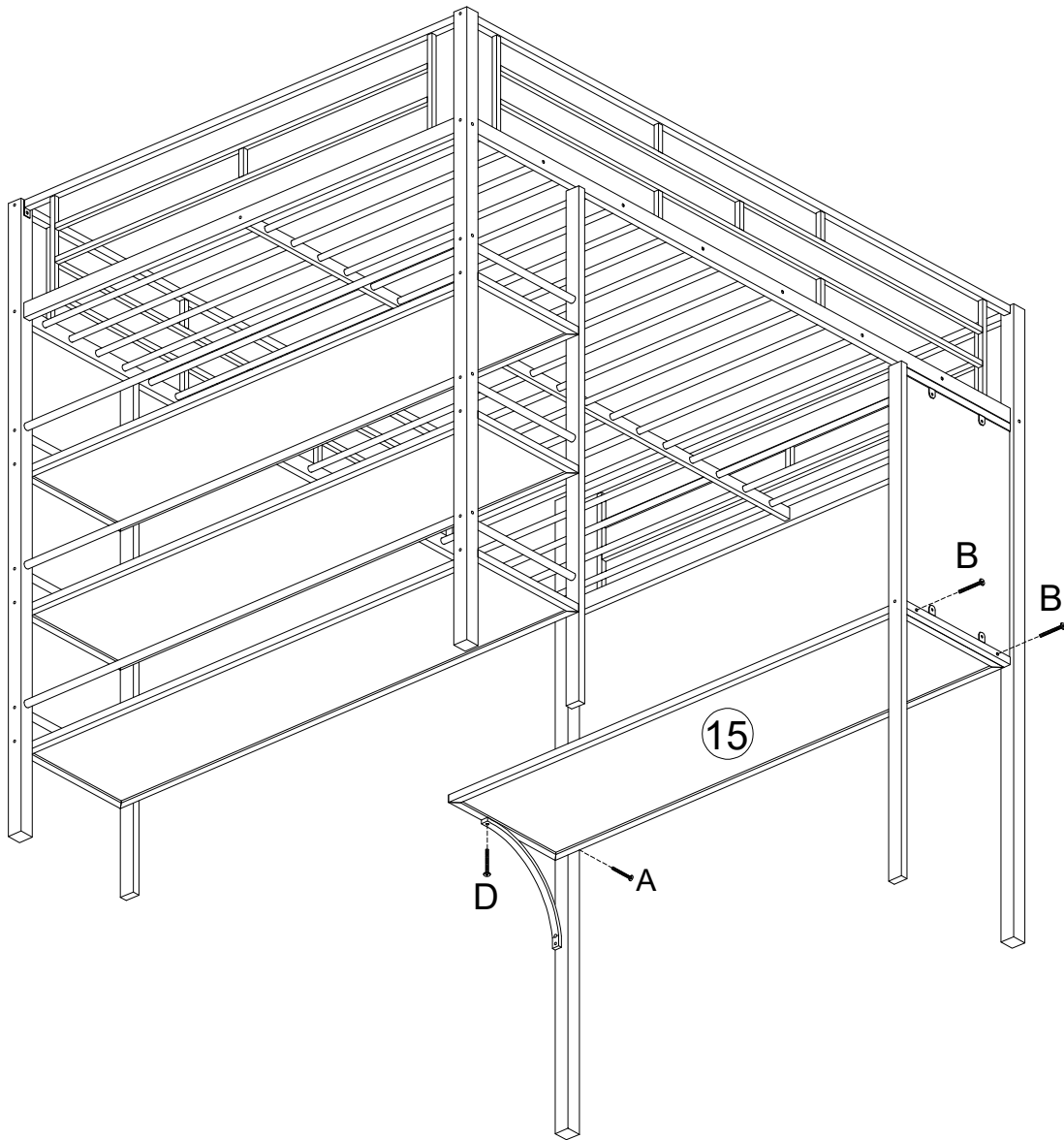

STEP 9

A	B	D
 M $\frac{1}{4}$ "x50	 M $\frac{1}{4}$ "x35	 M $\frac{1}{4}$ "x25
1 PCS	2 PCS	1 PC



STEP 10

E	G
 M $\frac{1}{4}$ "x15	 #20x20x13
2 PCS	2PCS

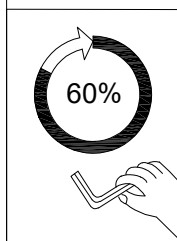
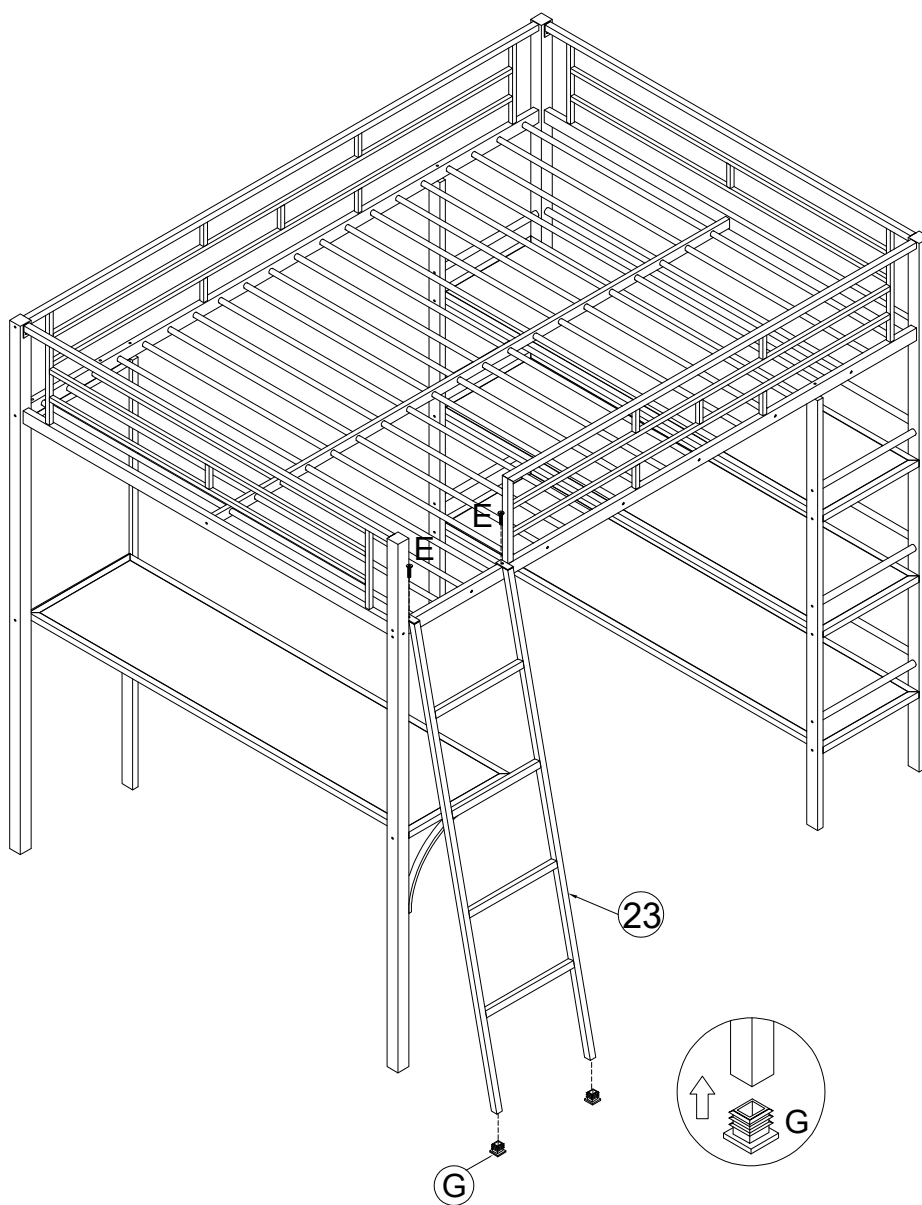

STEP 11

