

ASSEMBLY INSTRUCTION

MF298235/MF298236

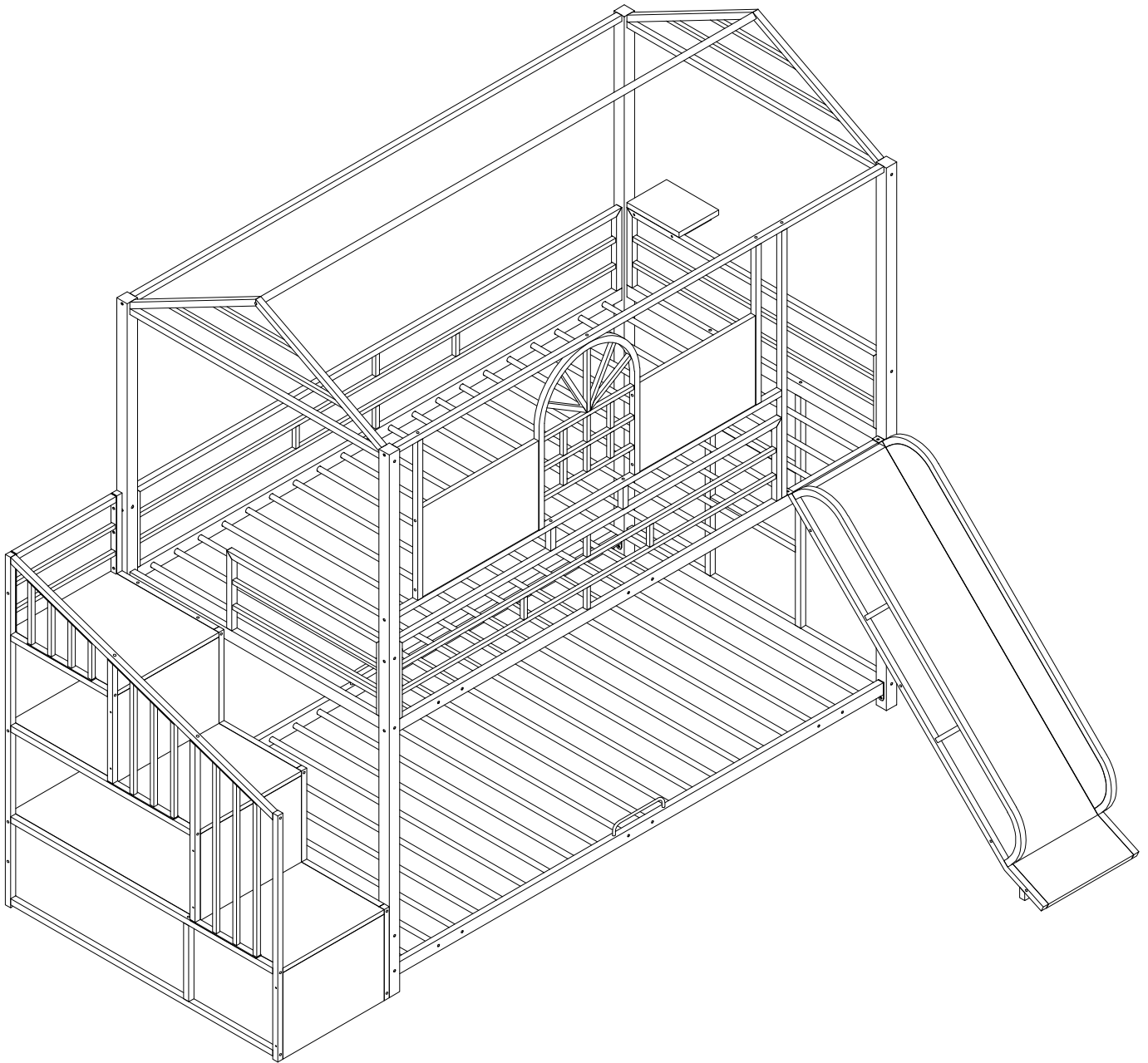

Minimum no. 2 of people
recommended to assemble
this product: Approx.
assembly time: 60 mins

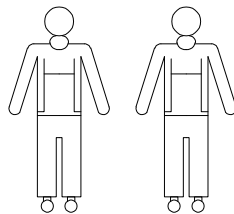

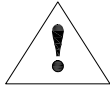

SAFETY WARNING



1. This bed is designed for use only mattress(es) meeting the following specifications on the upper bunk

Bed type	Length	Width	Thickness
Full Standard	74" - 75"	38.5"	6" Max

lower bunk

Bed type	Length	Width	Thickness
Full Standard	74" - 75"	38.5"	8"

2. Replacement parts, including additional guardrails, may be obtained from any of our (GIGACLOUD TECHNOLOGY(USA) INC. 18961 ARENTH A VENUE CITY OF INDUSTRY, CA, 91748) dealers
3. Follow the information on the warnings appearing on the upper bunk bed end structure and on the carton. Do not remove warning label from bed.
4. Always use the recommended size mattresses or mattress supports, or both, to help prevent the likelihood of entrapment or falls.
5. Surface of mattress must be at least 5" (127mm) below the upper edge of guardrails.
6. Do not allow children under 6 years of age to use the upper bunk.
7. Periodically check and ensure that the guardrail, ladder, and other components are in their proper position, free from damage, and that all connectors are tight.
8. Do not allow horseplay on or under the bed and prohibit jumping on the bed.
9. Always use the ladder for entering and leaving the upper bunk.
10. Do not use substitute part. Contact the manufacturer or dealer for replacement part.
11. Use of a night light may provide added safety precaution for a child using the upper bunk.
12. Always use guardrails on both long sides of upper bunk. If the bunk bed will be placed next to the wall, the guardrail that runs the full length of the bed should be placed against the wall to prevent entrapment between the bed and wall.
13. The use of water or sleep flotation mattresses is prohibited.
14. **STRANGULATION HAZARD** - Never attach or hang items to any part of the bunk bed that are not designed for use with the bed; for example, but not limited to, hook, belts and jump ropes.
15. Keep these instructions for future reference.
16. Prohibit more than one person on upper bunk.
17. We recommend assembling your bunk bed on the shipping carton to protect your floor or carpet.
18. Be certain all staples are out of the box before beginning assembly on the shipping carton.

1. At the beginning :

Tighten all hardware.

Check metal parts for rust. If found, sand and repaint using a non-lead-based paint meeting the requirements of 16 CFR 1303.

Check all wood members for deterioration and splinters. Sand down splinters and replace deteriorating wood members.

Rake and check depth of loose fill protective surfacing materials to prevent compaction and to maintain appropriate depth. Replace as necessary.

2. Twice a month

3. Tighten all hardware.

4. Rake and check depth of loose fill protective surfacing materials to prevent compaction and to maintain appropriate depth. Replace as necessary.

5. Owners shall be responsible for maintaining the legibility of the warning labels.

6. Disposal Instructions-

There shall be instructions advising the owner to disassemble and dispose of the playground equipment in such a way that no unreasonable hazards will exist at the time the playground equipment is discarded.

7. The instructions shall also include the information found in Section 4 of the United States Consumer Product Safety Commission's (USCPSC) Outdoor Home Playground Safety Handbook or specific surfacing guidelines for the product consistent with the USCPSC Handbook. A copy of this section may be found in Appendix X2.

8. Observing the following statements and warnings reduces the likelihood of serious or fatal injury.

9. Specifying the number and weight of occupants that may safely use the equipment singly or simultaneously,

10. Recommending on-site adult supervision for children of all ages,

11. Warning the owner to instruct children not to use the equipment in a manner other than intended,

12. Warning the owner to instruct children not to get off equipment while it is in motion,

13. Warning the owner not to allow children to wear inappropriate items, such as but not limited to, loose fitting clothing, hood and neck drawstrings, scarves, cord-connected items, capes and ponchos. These items can cause death by strangulation.

14. Warning the owner to instruct children not to climb when the equipment is wet.

15. Warning the owner to instruct children not to attach items to the playground equipment that are not specifically designed for use with the equipment, such as, but not limited to, jump ropes, clothesline, pet leashes, cables and chain as they may cause a strangulation hazard

16. Warning the owner to instruct children to remove their bike or other sports helmet before playing on the playground equipment.

17. Warning the owner to dress children with well-fitting and full foot enclosing footwear. Examples of inappropriate footwear are clogs, flip flops, and sandals.







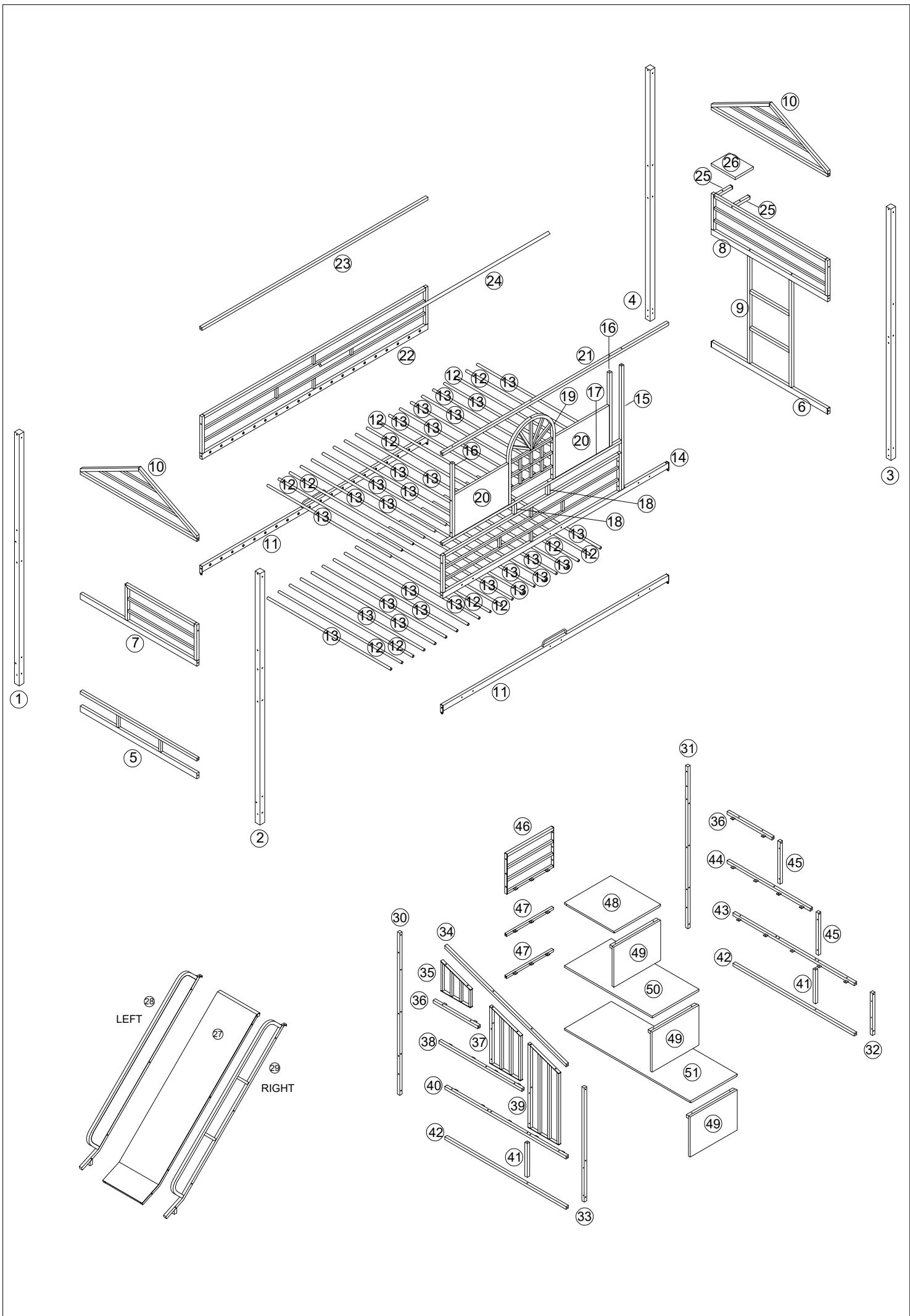

18. Place the equipment on level ground, not less than 6 ft (1.8 m) from any structure or obstruction such as a fence, garage, house, overhanging branches, laundry lines, or electrical wires

19. Do not install home playground equipment over concrete, asphalt, packed earth, grass, carpet, or any other hard surface. A fall onto a hard surface can result in serious injury or death to the equipment user

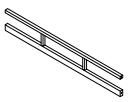
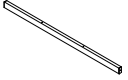
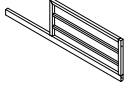
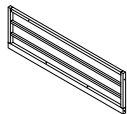
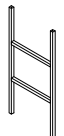
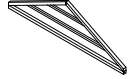
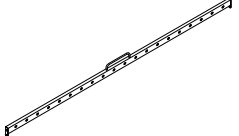
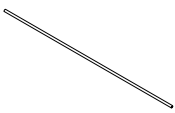
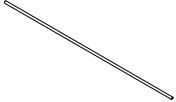
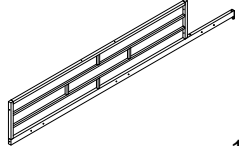

20. To prevent serious injury, cautionary statements shall be included which warn that children must not use the equipment until properly installed.

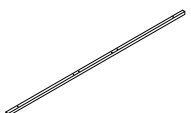

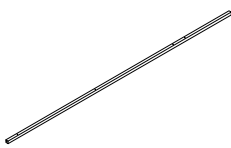



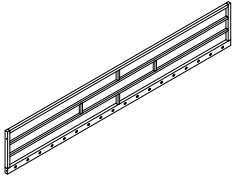
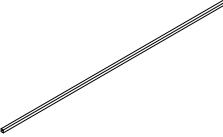
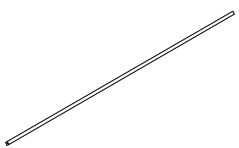



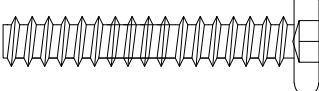
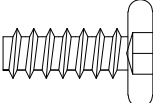

PART LIST MF298235

<p>1</p>  <p>1PC</p>	<p>2</p>  <p>1PC</p>	<p>3</p>  <p>1PC</p>
<p>4</p>  <p>1PC</p>	<p>5</p>  <p>1PC</p>	<p>6</p>  <p>1PC</p>
<p>7</p>  <p>1PC</p>	<p>8</p>  <p>1PC</p>	<p>9</p>  <p>1PC</p>
<p>10</p>  <p>2PCS</p>	<p>11</p>  <p>2PCS</p>	<p>12</p>  <p>12PCS</p>
<p>13</p>  <p>28PCS</p>	<p>14</p>  <p>1PC</p>	<p>15</p>  <p>1PC</p>
<p>16</p>  <p>2PCS</p>	<p>17</p>  <p>1PC</p>	<p>18</p>  <p>2PCS</p>
<p>19</p>  <p>1PC</p>	<p>21</p>  <p>1PC</p>	





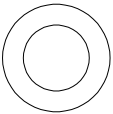





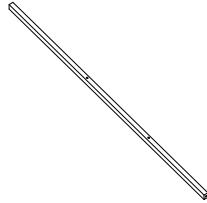

PART LIST MF298235

<div data-bbox="60 197 103 235" style="border: 1px solid black; padding: 2px;">22</div>  <p style="text-align: center;">1PC</p>	<div data-bbox="555 197 598 235" style="border: 1px solid black; padding: 2px;">23</div>  <p style="text-align: center;">1PC</p>	<div data-bbox="1050 197 1093 235" style="border: 1px solid black; padding: 2px;">24</div>  <p style="text-align: center;">1PC</p>
<div data-bbox="60 459 103 497" style="border: 1px solid black; padding: 2px;">25</div>  <p style="text-align: center;">2PCS</p>		

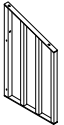
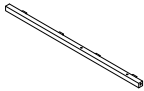
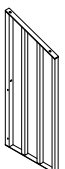
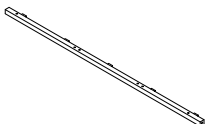
HARDWARE LIST MF298235

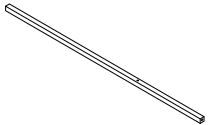
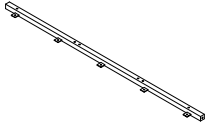
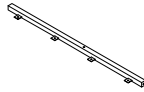
<div data-bbox="87 1355 119 1400" style="font-weight: bold;">A</div>  <p style="text-align: center;">M$\frac{1}{4}$"X50 37 PCS</p>	<div data-bbox="454 1355 486 1400" style="font-weight: bold;">B</div>  <p style="text-align: center;">M$\frac{1}{4}$"X30 2 PCS</p>	<div data-bbox="821 1355 853 1400" style="font-weight: bold;">C</div>  <p style="text-align: center;">M$\frac{1}{4}$"X35 73 PCS</p>	<div data-bbox="1197 1355 1228 1400" style="font-weight: bold;">D</div>  <p style="text-align: center;">M$\frac{1}{4}$"X15 41 PCS</p>
<div data-bbox="87 1590 119 1635" style="font-weight: bold;">E</div>  <p style="text-align: center;">M4X23X57 1 PC</p>	<div data-bbox="454 1590 486 1635" style="font-weight: bold;">F</div>  <p style="text-align: center;">#40x40 4 PCS</p>	<div data-bbox="821 1590 853 1635" style="font-weight: bold;">G</div>  <p style="text-align: center;">#20x20 10 PCS</p>	<div data-bbox="1197 1590 1228 1635" style="font-weight: bold;">H</div>  <p style="text-align: center;">M4x30 18 PCS</p>
<div data-bbox="87 1780 119 1825" style="font-weight: bold;">i</div>  <p style="text-align: center;">M4x15 31 PCS</p>	<div data-bbox="454 1780 486 1825" style="font-weight: bold;">j</div>  <p style="text-align: center;">20x20 1 PC</p>	<div data-bbox="821 1780 853 1825" style="font-weight: bold;">K</div>  <p style="text-align: center;">Ø6x15 143 PCS</p>	<div data-bbox="1197 1780 1228 1825" style="font-weight: bold;">L</div>  <p style="text-align: center;">Ø6x10 8 PCS</p>

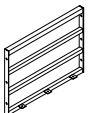
PART LIST MF298236

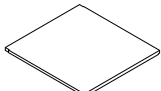
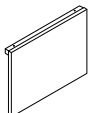
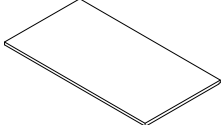
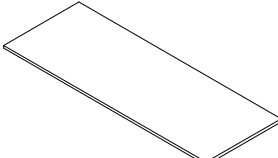
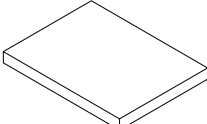
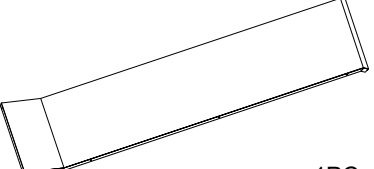
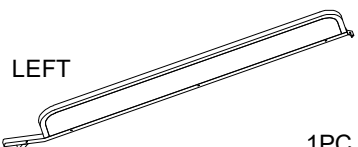
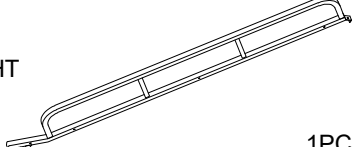
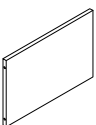
<p>30</p>  <p>1PC</p>	<p>31</p>  <p>1PC</p>	<p>32</p>  <p>1PC</p>
<p>33</p>  <p>1PC</p>	<p>34</p>  <p>1PC</p>	<p>35</p>  <p>1PC</p>
<p>36</p>  <p>2PCS</p>	<p>37</p>  <p>1PC</p>	<p>38</p>  <p>1PC</p>
<p>39</p>  <p>1PC</p>	<p>40</p>  <p>1PC</p>	<p>41</p>  <p>2PCS</p>
<p>42</p>  <p>2PCS</p>	<p>43</p>  <p>1PC</p>	<p>44</p>  <p>1PC</p>
<p>45</p>  <p>2PCS</p>	<p>46</p>  <p>1PC</p>	<p>47</p>  <p>2PCS</p>
<p>48</p>  <p>1PC</p>	<p>49</p>  <p>3PCS</p>	<p>50</p>  <p>1PC</p>
<p>51</p>  <p>1PC</p>	<p>26</p>  <p>1PC</p>	<p>27</p>  <p>1PC</p>
<p>28</p> <p>LEFT</p>  <p>1PC</p>	<p>29</p> <p>RIGHT</p>  <p>1PC</p>	<p>20</p>  <p>2PCS</p>

STEP 1

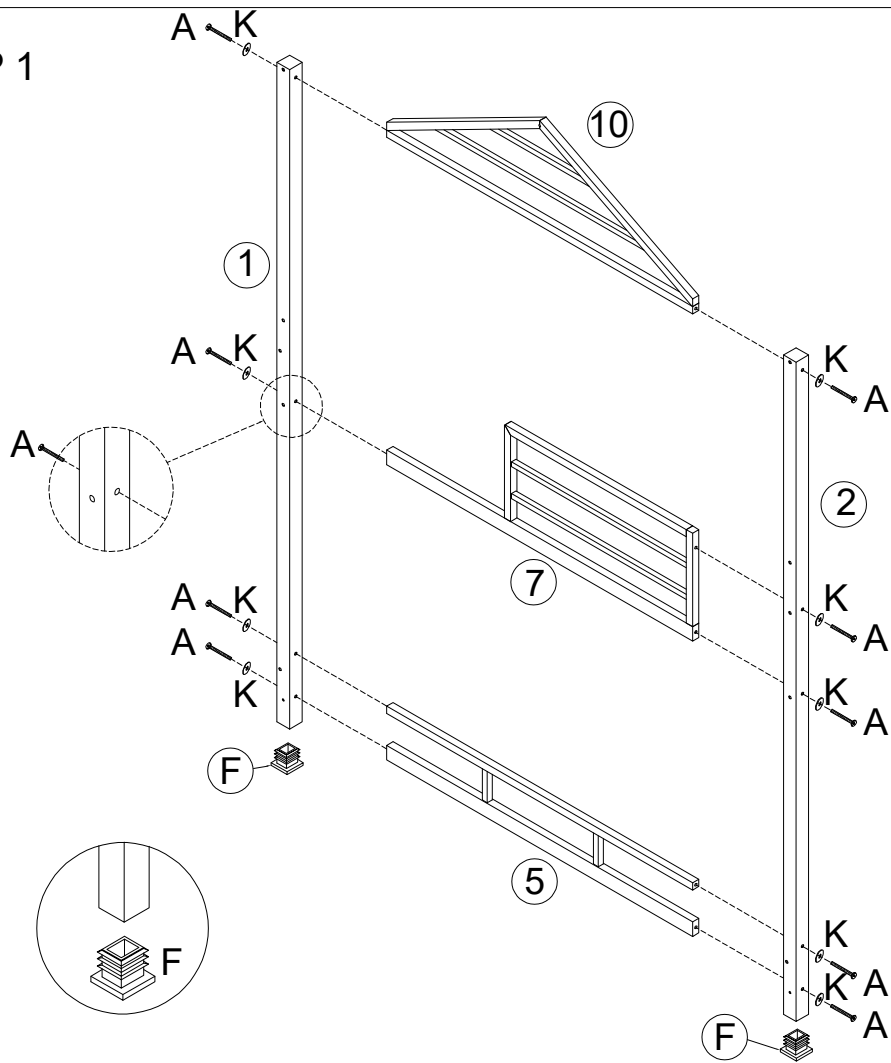

A	F	K
M $\frac{1}{4}$ "x50	#40x40	Ø6x13
9 pcs	2 pcs	9 pcs

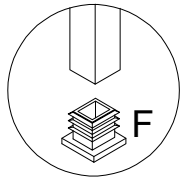
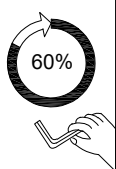

STEP 2

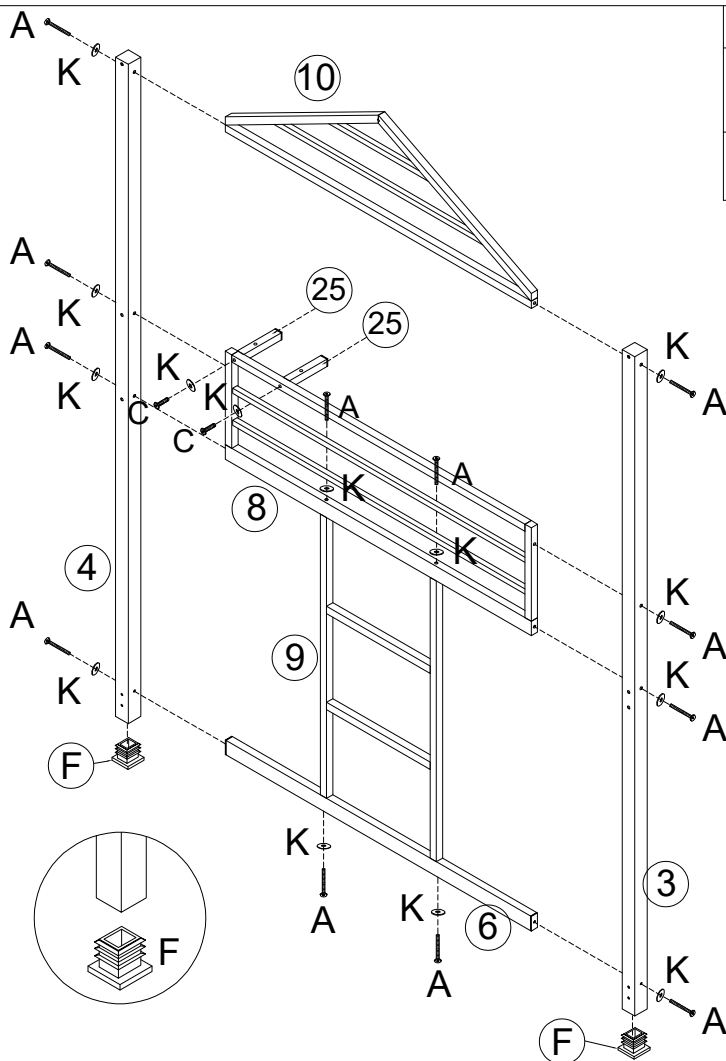

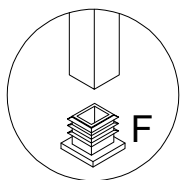
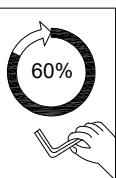

A	C	F	K
M $\frac{1}{4}$ "x50	M $\frac{1}{4}$ "x35	#40x40	Ø6x13
12 pcs	2 pcs	2 pcs	14 pcs

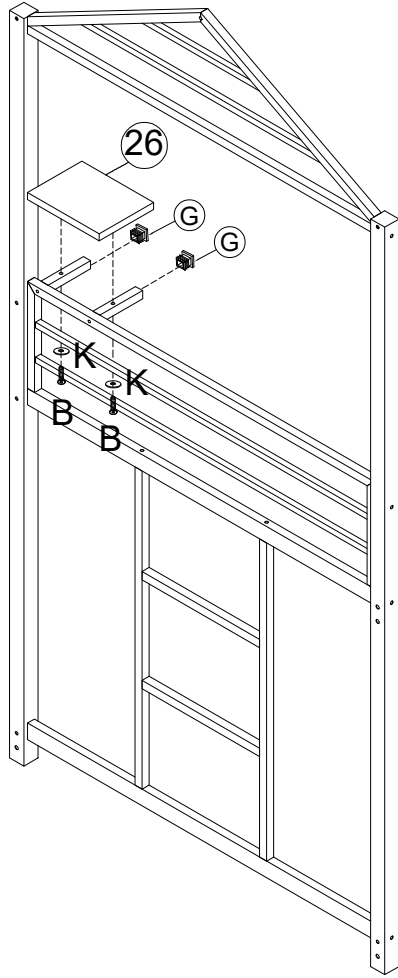

STEP 3



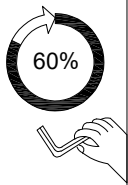

B	G	K
		
M $\frac{1}{4}$ "x30	#20x20	Ø6x13
2 pcs	2 pcs	2 pcs



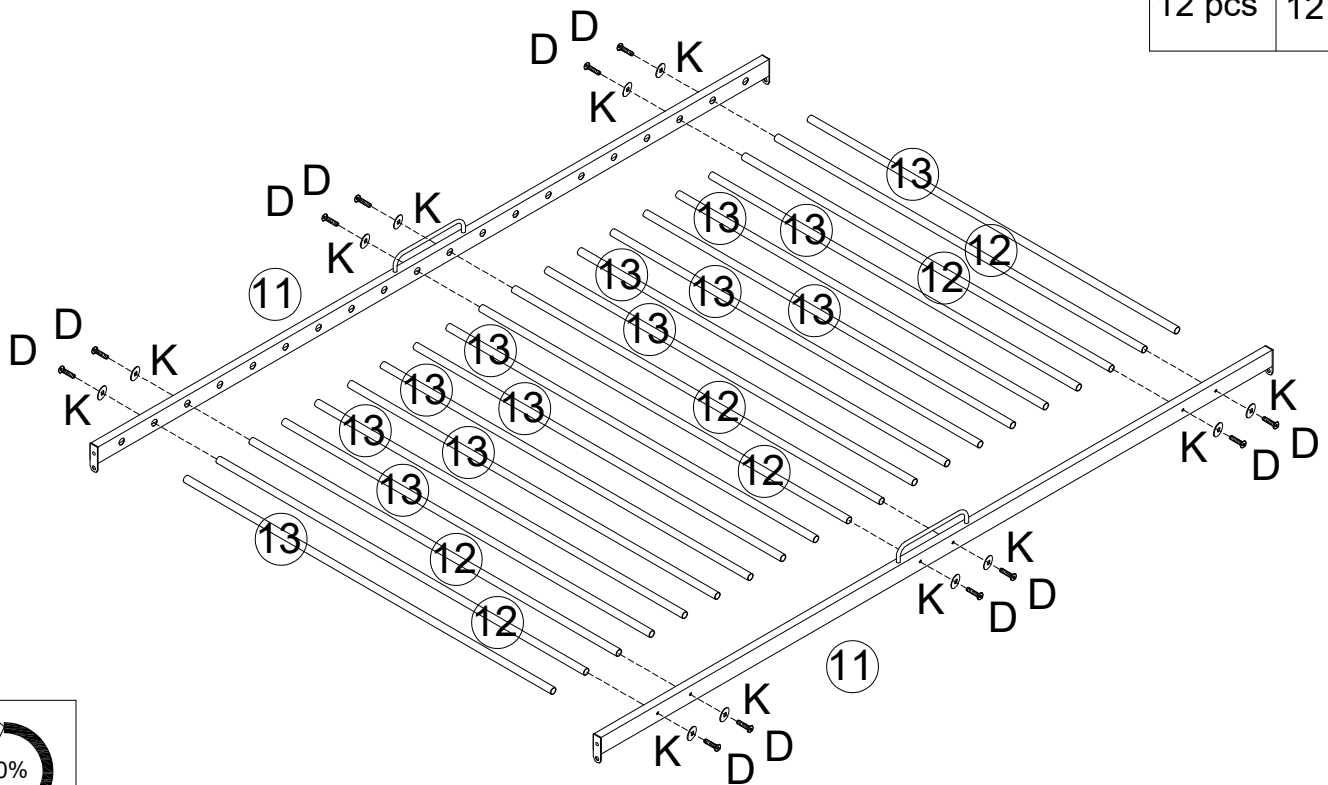

STEP 4

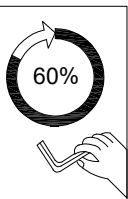

D	K
	
M $\frac{1}{4}$ "x15	Ø6x13
12 pcs	12 pcs





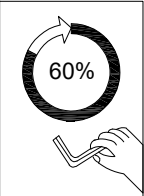
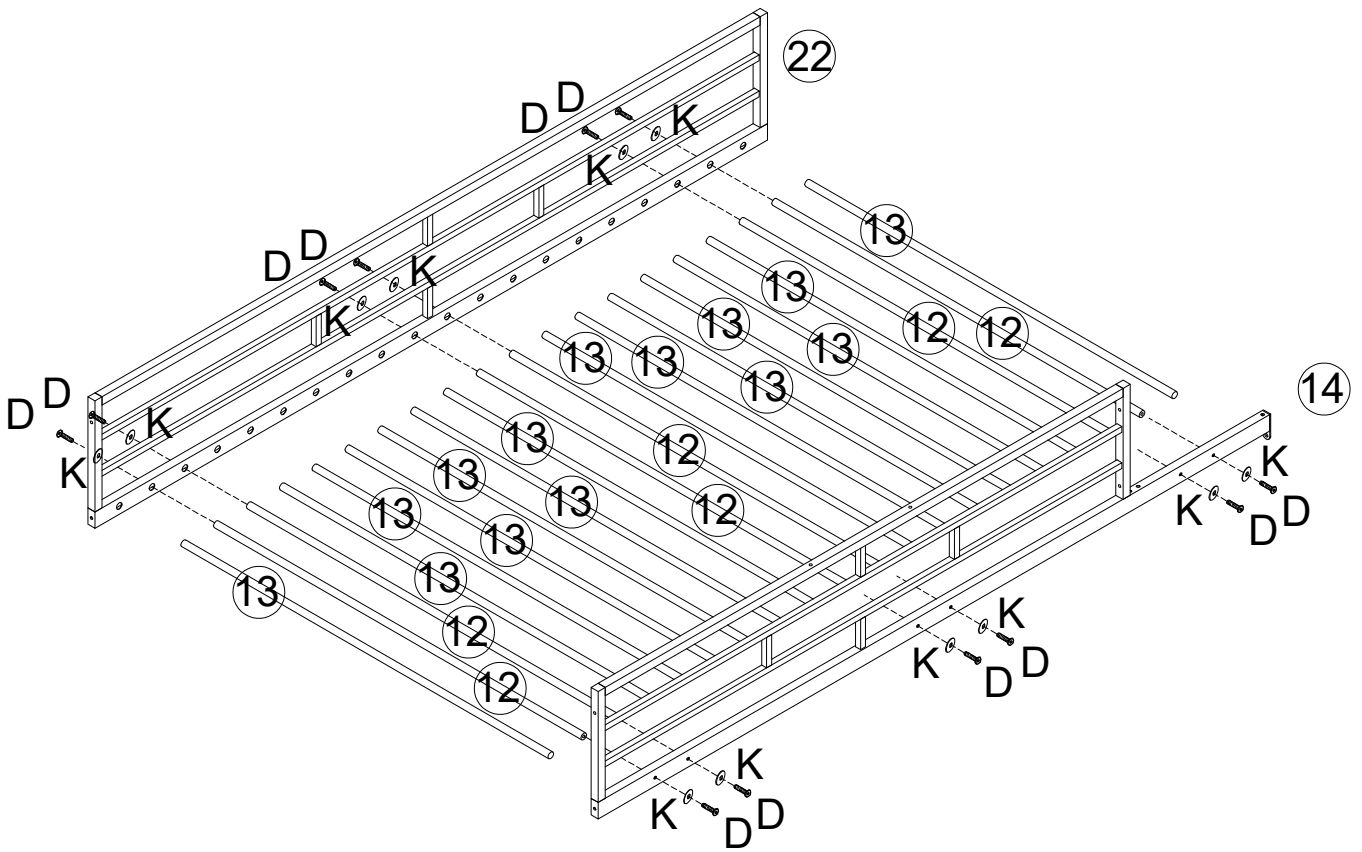

STEP 5

D	K
 M ₄ ¹ x15	 Ø6x13
12 pcs	12 pcs



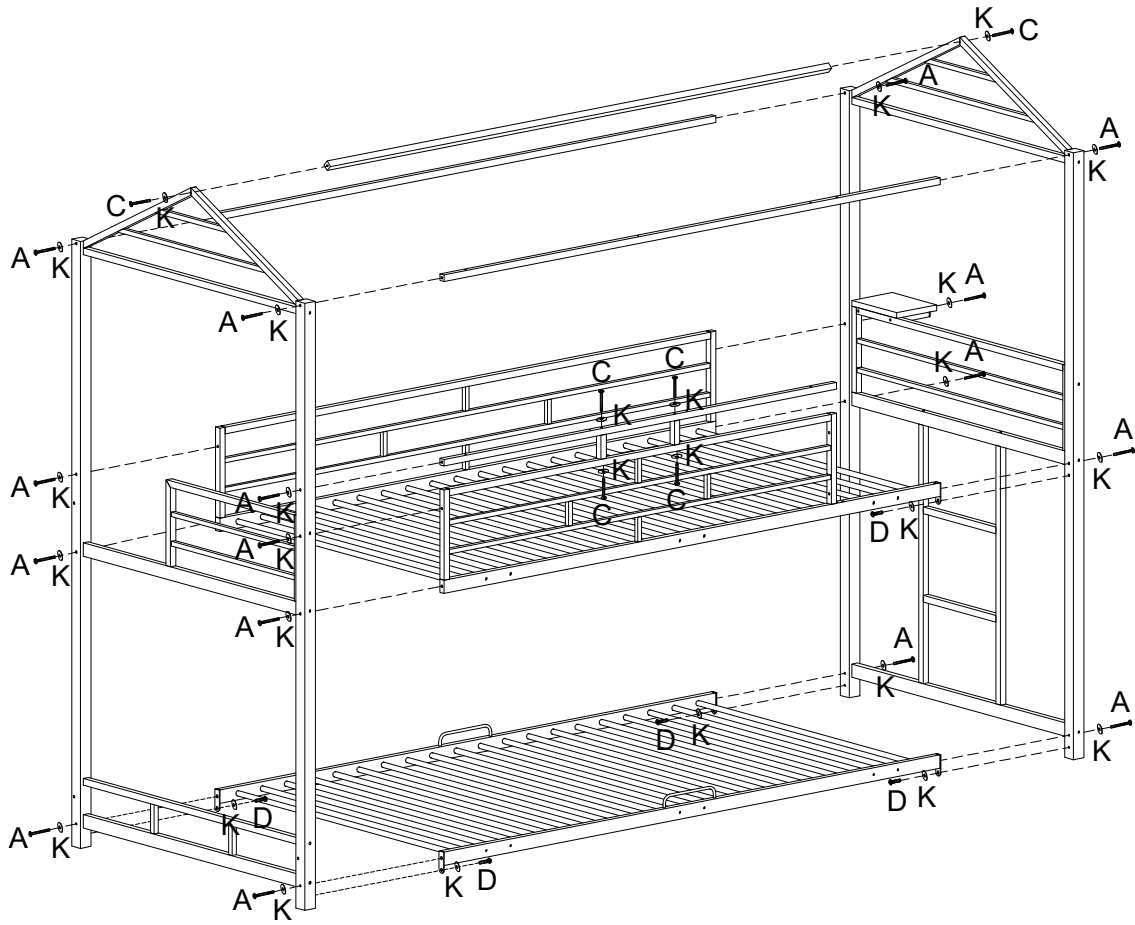

STEP 6

A	C	D	K
			
M $\frac{1}{4}$ x50	M $\frac{1}{4}$ x35	M $\frac{1}{4}$ x15	Ø6x13
16 pcs	6 pcs	5 pcs	27 pcs



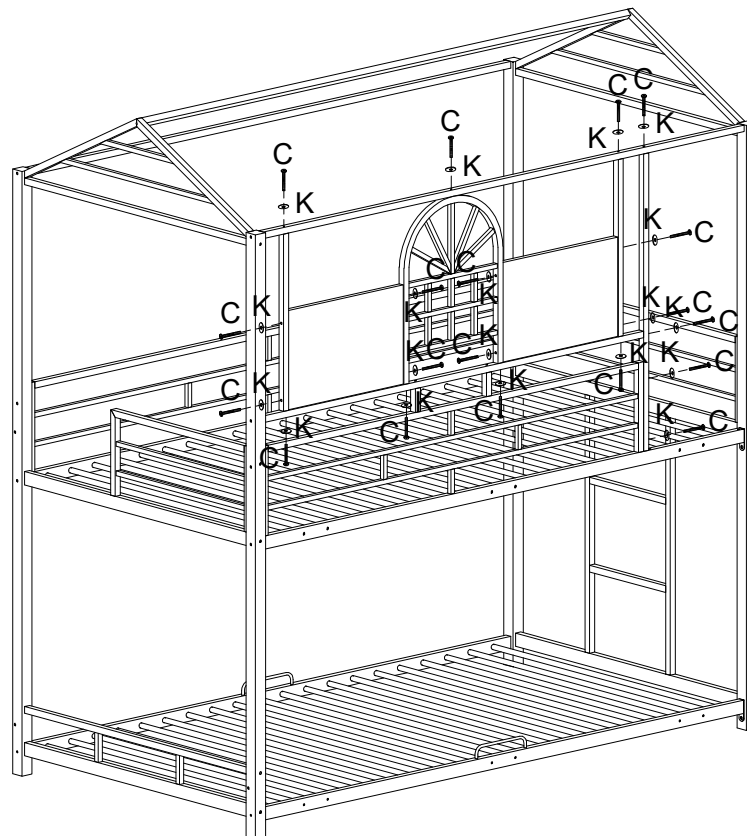

STEP 7

C	K
	
M $\frac{1}{4}$ x35	Ø6x13
19 pcs	19 pcs





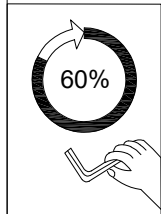
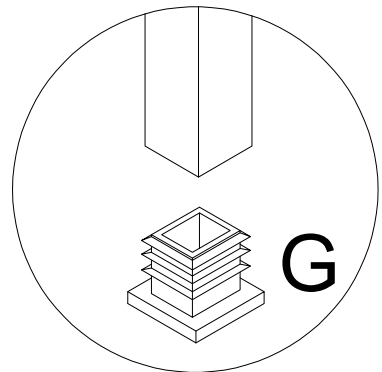
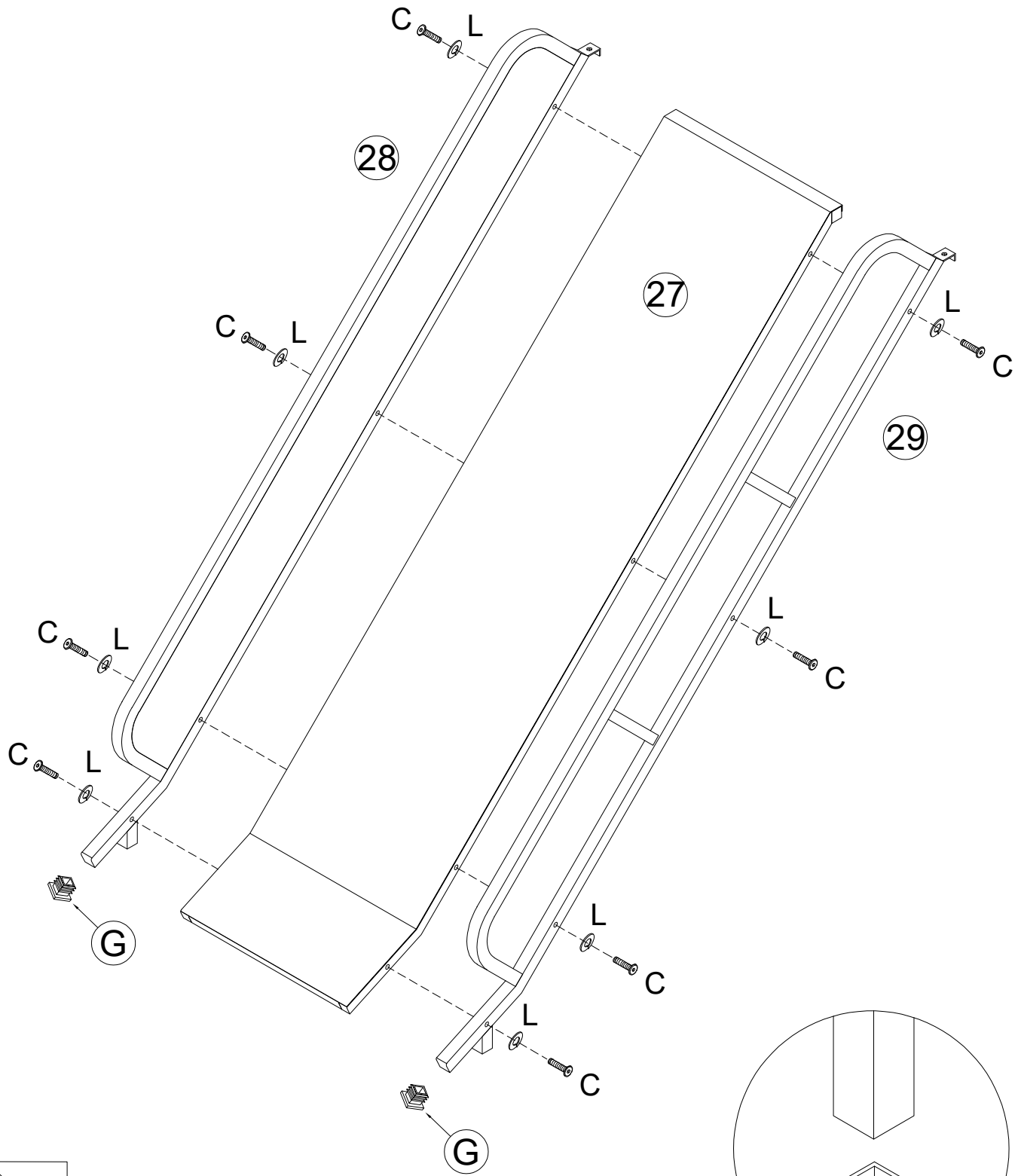

STEP 8

C	L	G
 M $\frac{1}{4}$ x35	 Ø6x10	 #20x20
8 pcs	8 pcs	4 pcs



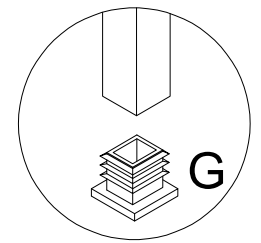
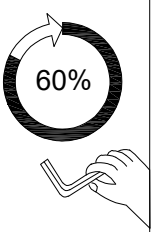
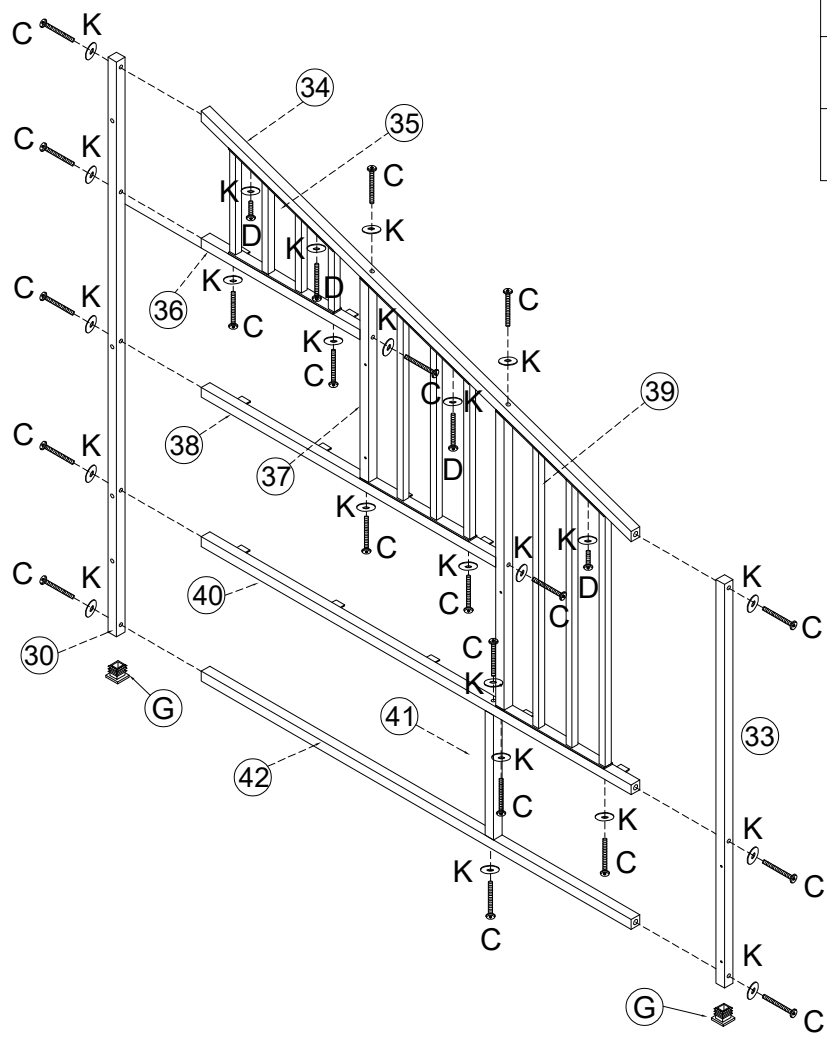

STEP 9

C	D	G	K
 M $\frac{1}{4}$ "x35	 M $\frac{1}{4}$ "x15	 #20x20	 Ø6x15
20 pcs	4 pcs	2 pcs	24 pcs



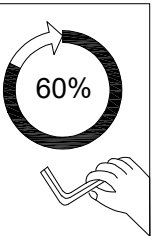
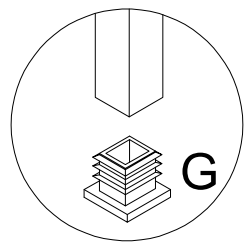
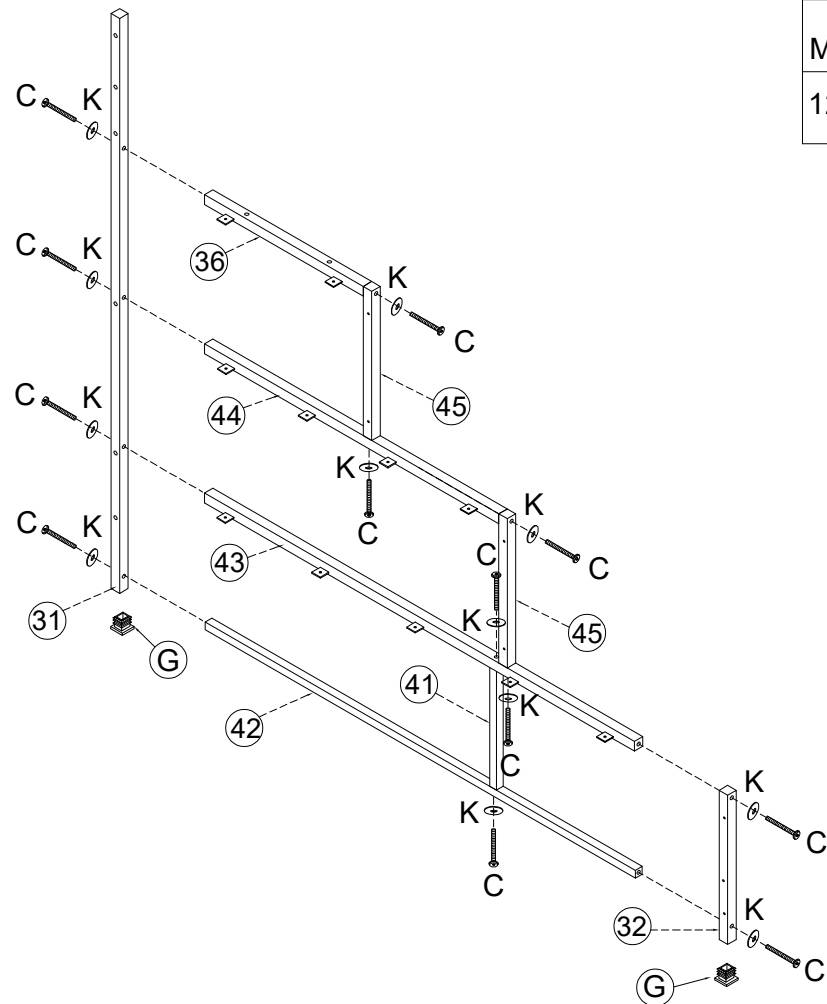

STEP 10

C	G	K
 M $\frac{1}{4}$ "x35	 #20x20	 Ø6x15
12 pcs	2 pcs	12 pcs



STEP 11

C	D	K
		
M $\frac{1}{4}$ x35	M $\frac{1}{4}$ x15	Ø6x15
4 pcs	4 pcs	8 pcs

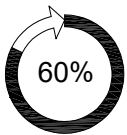
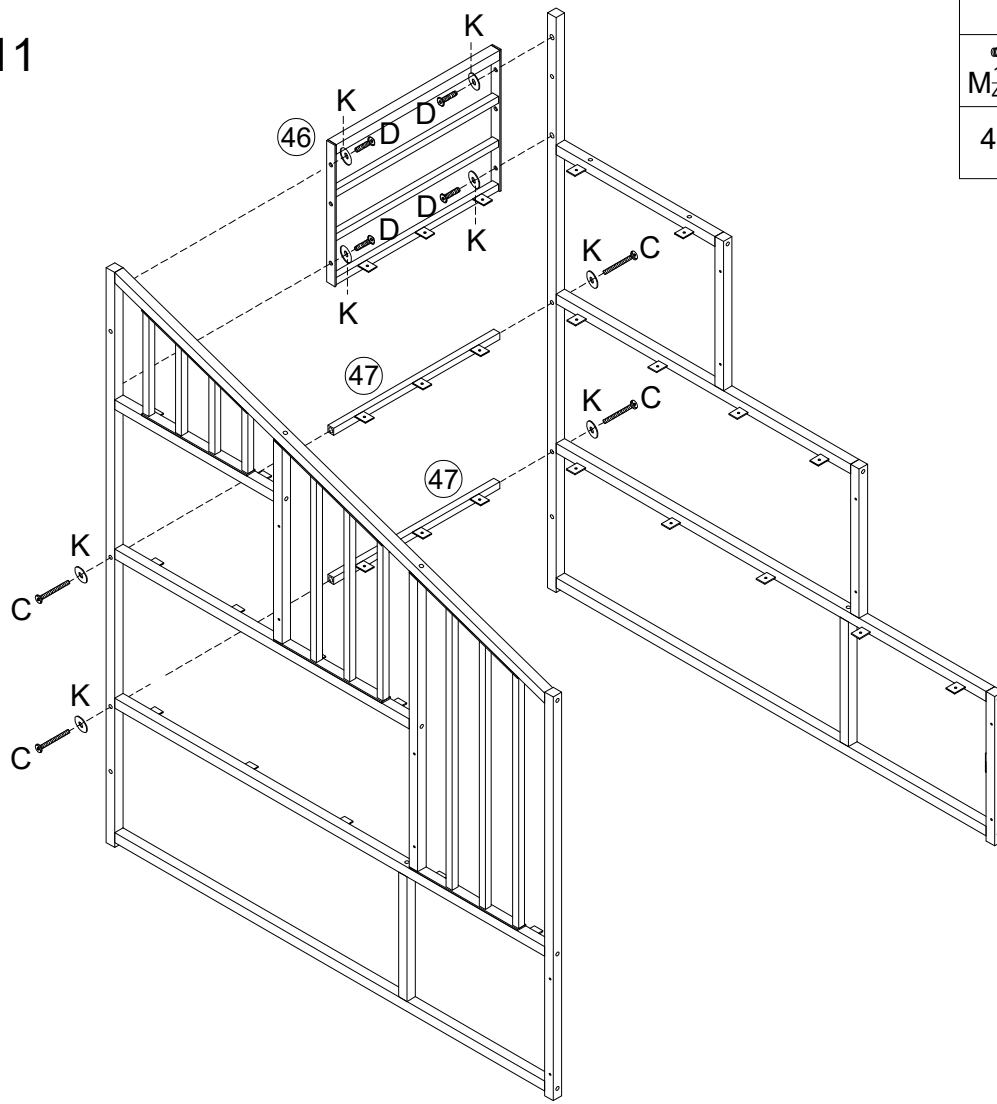

60%



STEP 12

H

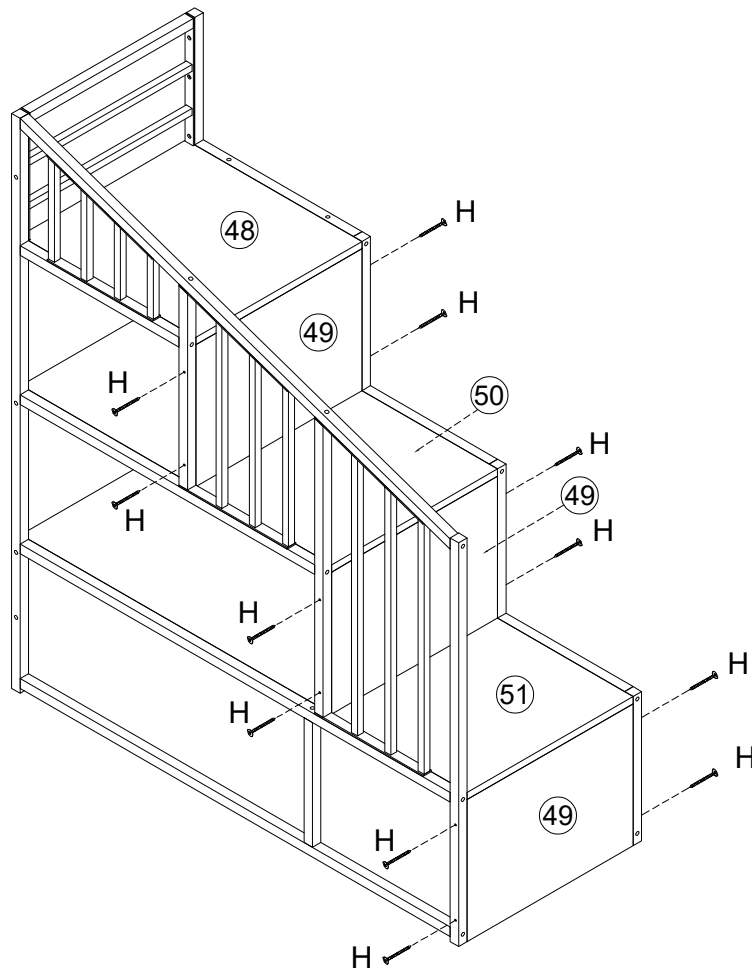
M4x30
12 pcs



360°



STEP 13

H
 M4x30
6 pcs

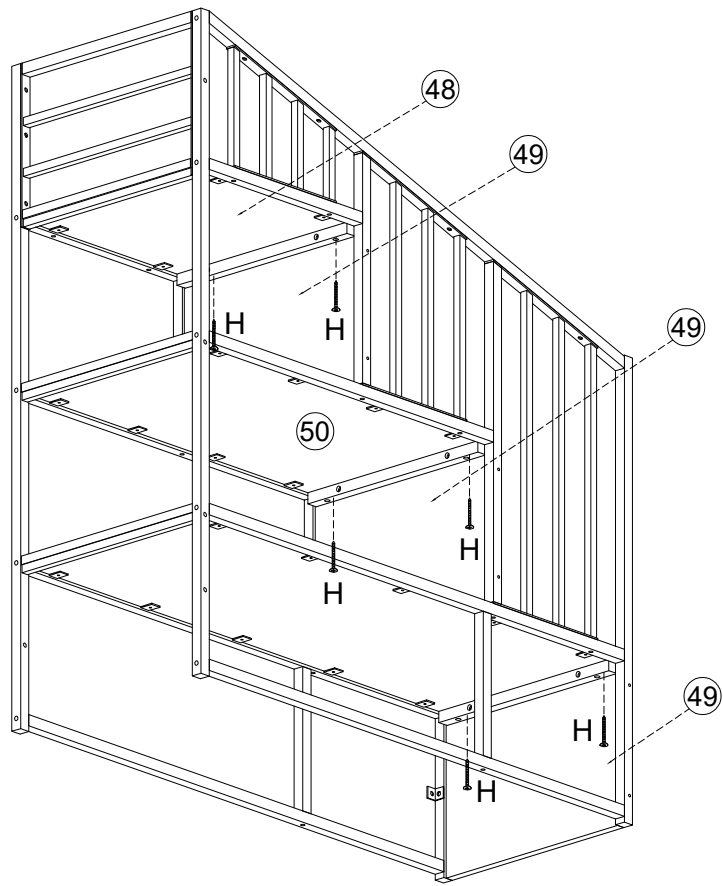

STEP 14

i
 M4x15
31 pcs

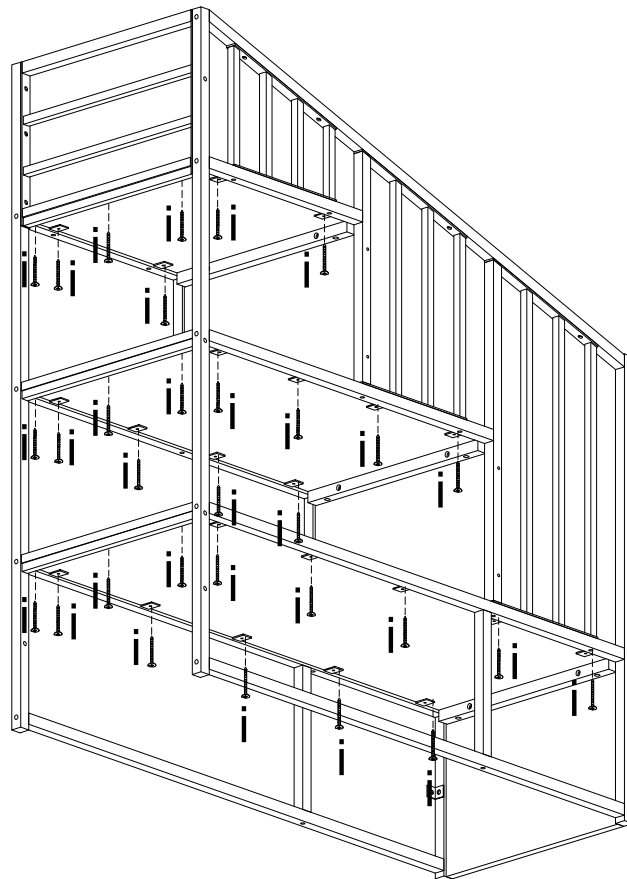

STEP 15

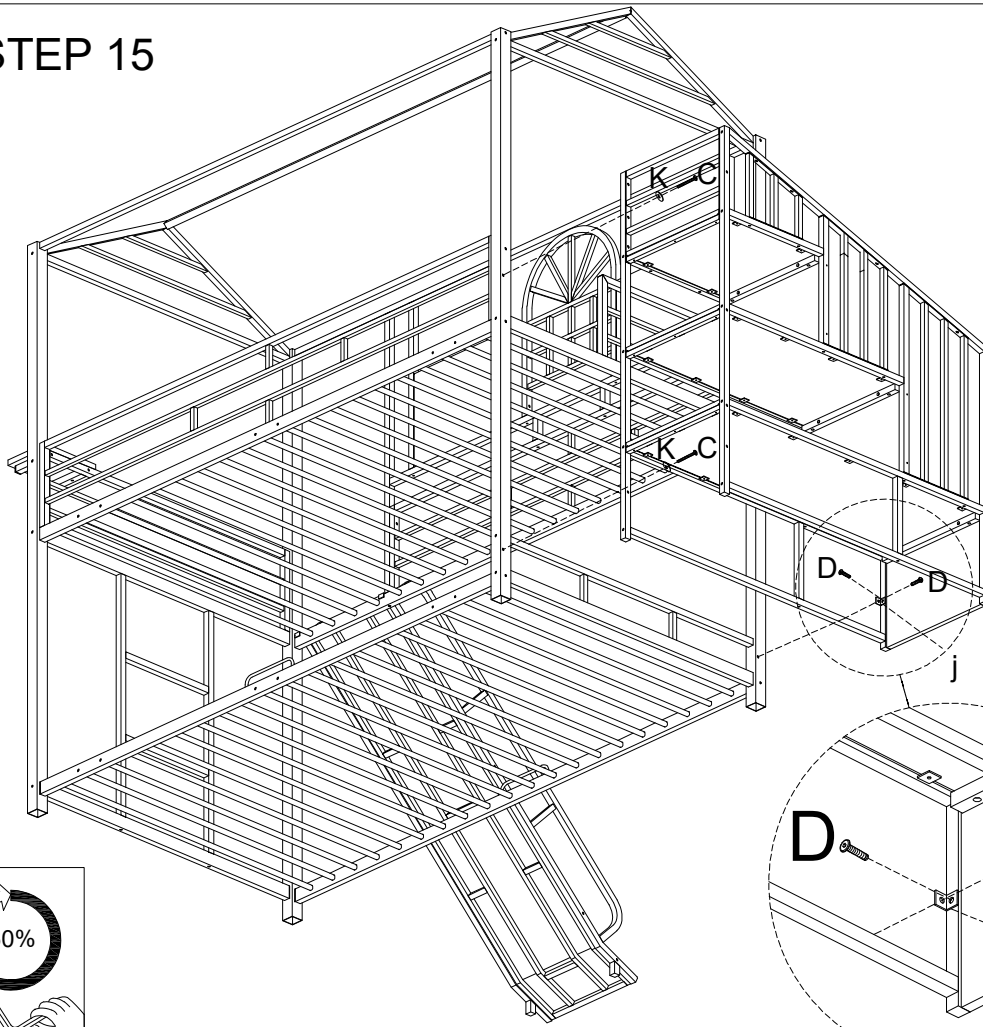

j	K
20x20	Ø6x15
1 pcs	2 pcs

M $\frac{1}{4}$ x15 2 pcs	D
M $\frac{1}{4}$ x35 2 pcs	C

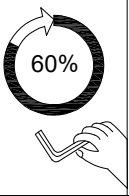

STEP 16

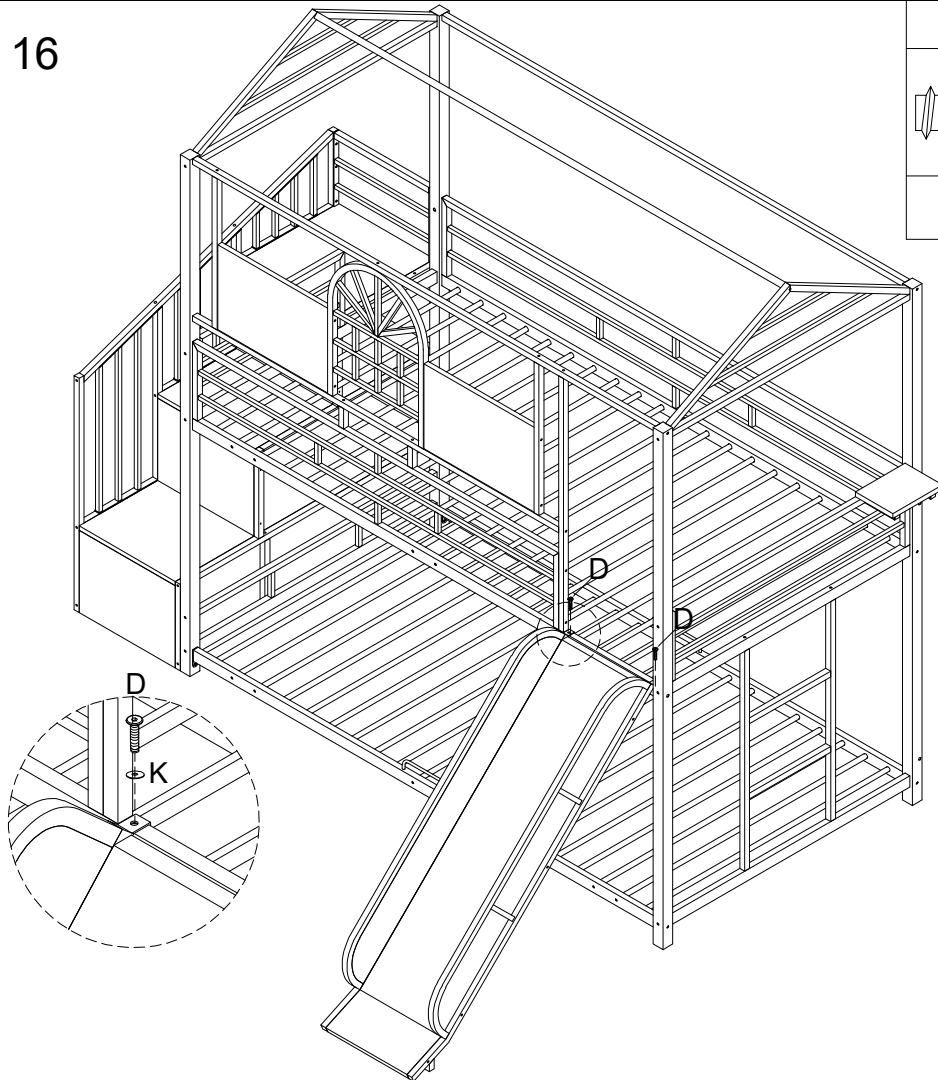

D	K
M $\frac{1}{4}$ x15	Ø6x15
2 pcs	2 pcs

