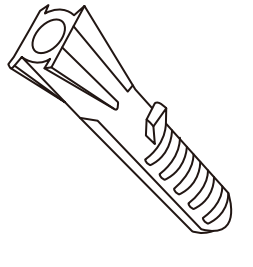
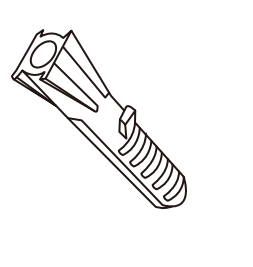
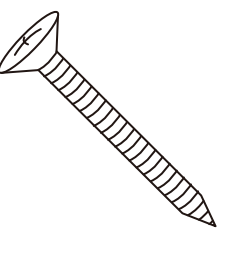
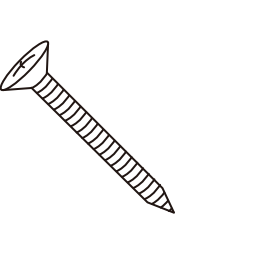
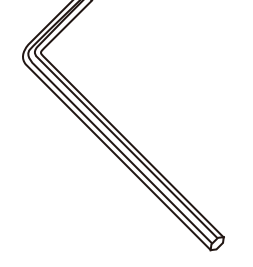
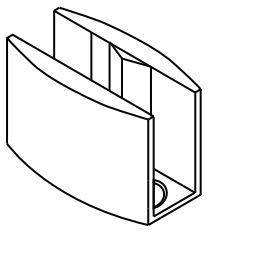
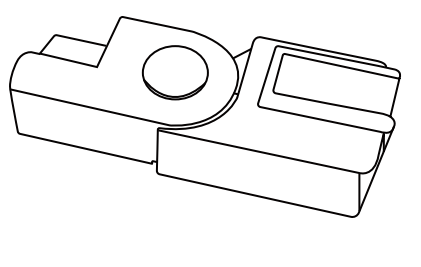
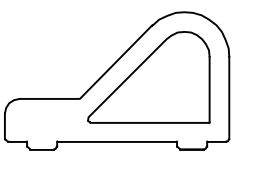
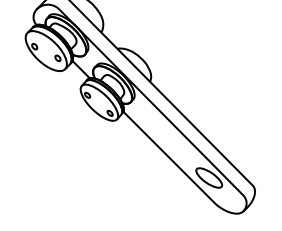
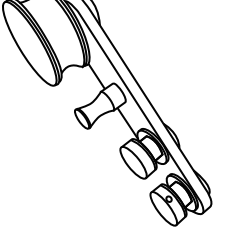
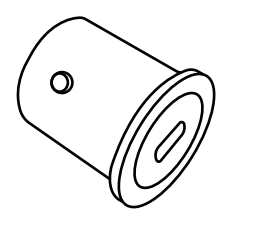
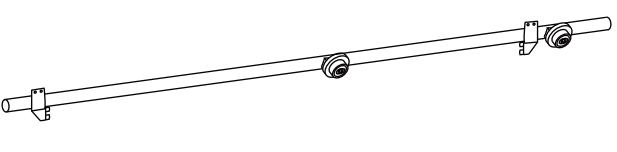
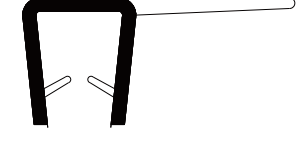
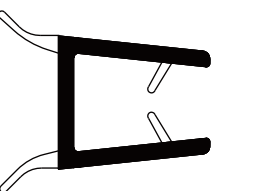
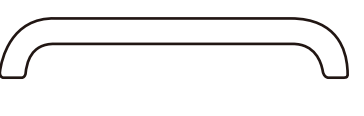
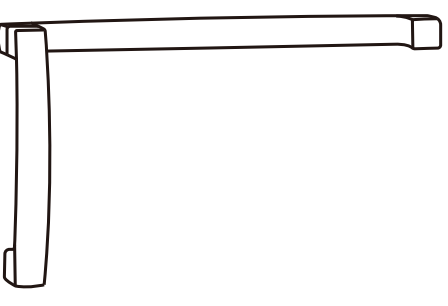
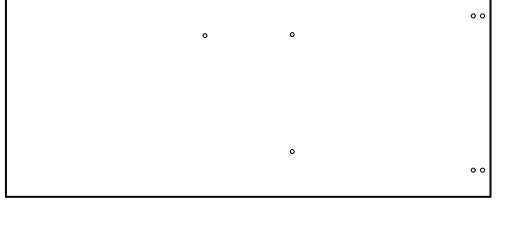
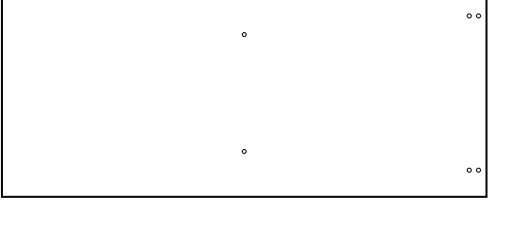
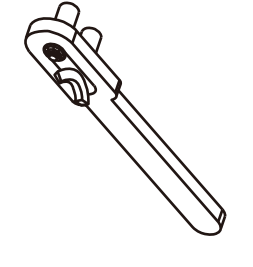
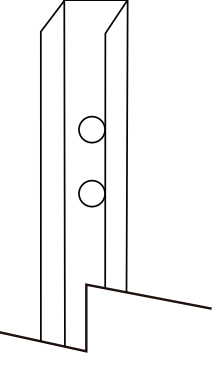
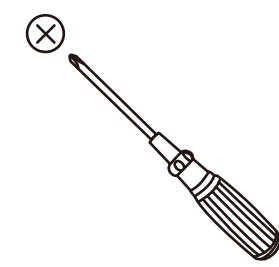
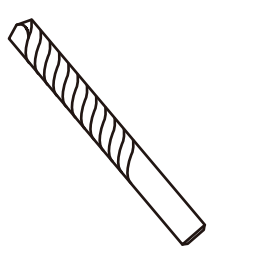
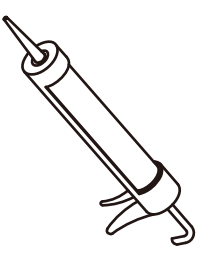
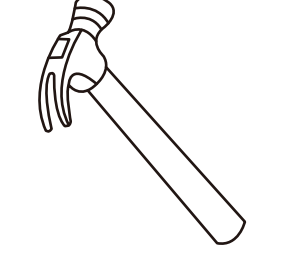
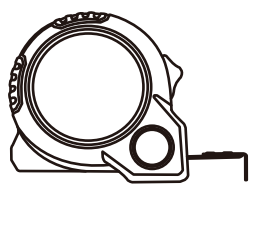
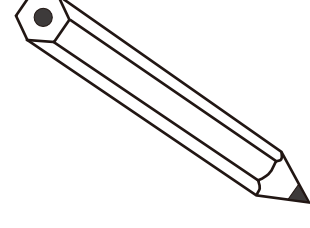
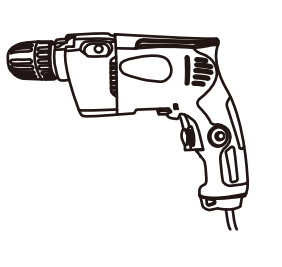
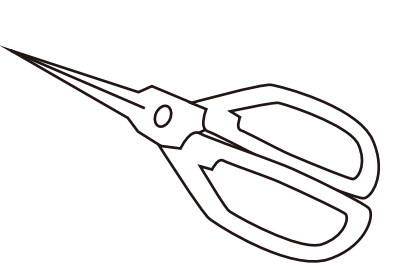
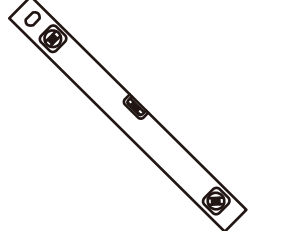

Check carefully after opening the box. Make sure there are no missing pieces and the shower doors do not have any cracks. During installation, please be careful with the corners of the glass doors. They are very fragile. After the shower doors are installed, the sliding doors should be parallel to each other to open and close smoothly, without gaps or water seepage, and the shower and the bottom basin should be sealed with silicone between them.

### Parts list

 <b>A-1×2</b> Internal accessories length: 35mm	 <b>A-2×2</b> Internal accessories length: 25mm	 <b>B-1×2</b> Internal accessories length: 40mm	 <b>B-2×2</b> Internal accessories length: 30mm	 <b>C×2</b> Internal accessories Nail bit	 <b>D×1</b> Internal accessories Guide Block	 <b>E×2</b> Internal accessories Aluminum Cover-Right
 <b>F×1</b> Internal accessories Anti-splash Threshold	 <b>G×2</b> Internal accessories Glass Bracket	 <b>H×2</b> Internal accessories length: 190mm	 <b>I×2</b> Internal accessories Guide Rail Bracket	 <b>J×1</b> Internal accessories Upper Guide Rail	 <b>K×2</b> Internal accessories Water blocking	 <b>L×1</b> Internal accessories Water blocking
 <b>M×1</b> Internal accessories Handle	 <b>N×1</b> Internal accessories Handle	 <b>O×2</b> Internal accessories Glass	 <b>P×1</b> Internal accessories Glass	 <b>Q×1</b> Internal accessories Nail bit	 <b>R×1</b> Aluminum material Measuring Tool	

### Tools Not Included

 <b>Phillips screwdriver</b> Tools needed	 <b>Assorted Drill Bits</b> Tools needed
 <b>Glue gun</b> Sillicona Nail bit	 <b>Adjustable Wrench</b> Nail bit
 <b>Internal accessories</b> Tools needed	 <b>Internal accessories</b> Tools needed
 <b>Percussion Drill</b> Tools needed	 <b>Internal accessories</b> Tools needed
 <b>Level</b> Tools needed	

### Package contents

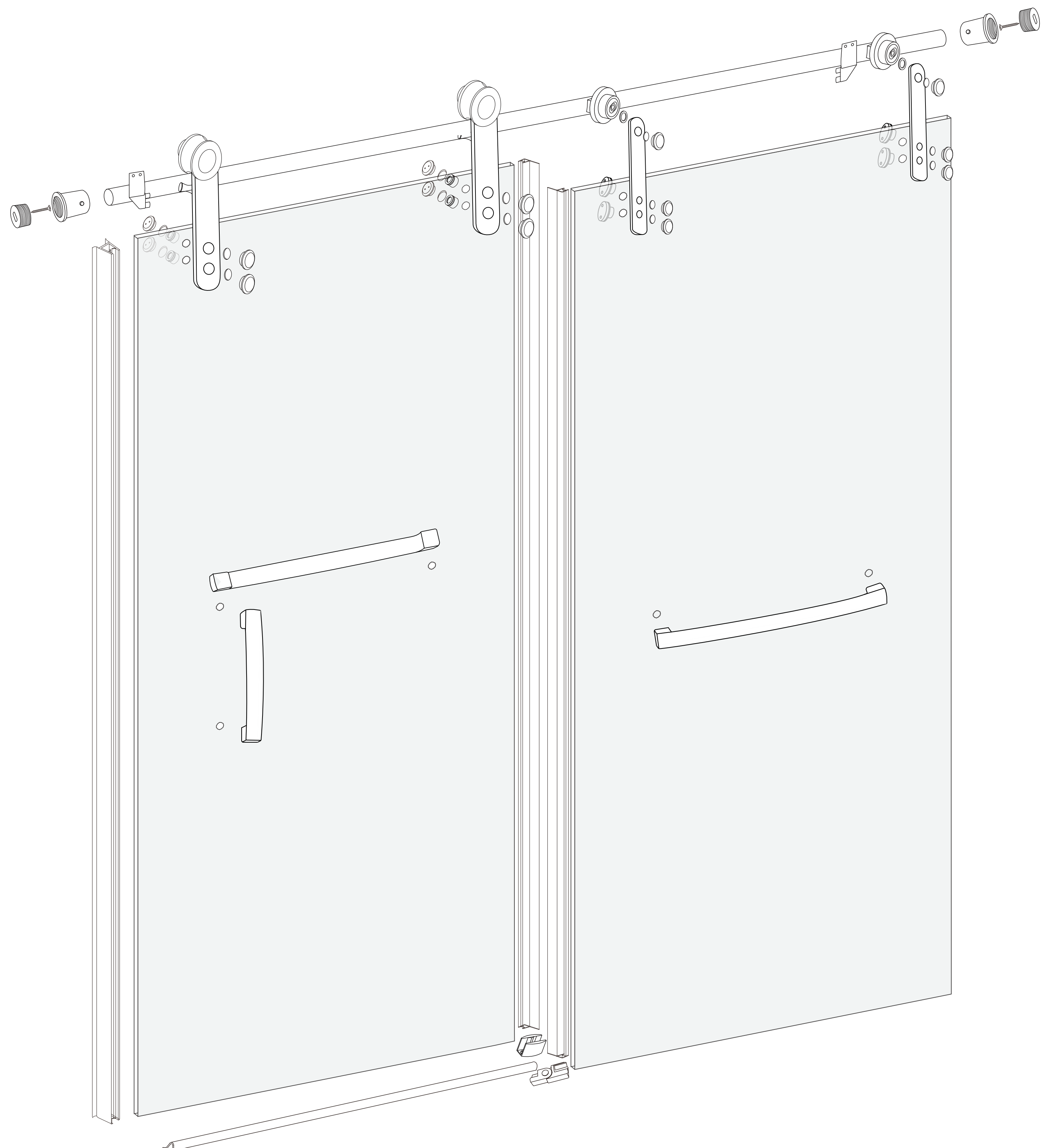

The following instructions will guide you through the installation of a sliding shower door.

\*Glass doors can be installed on either side.  
Frame parts will need to be flipped over to install the sliding door on the left or right side.

## Step 01

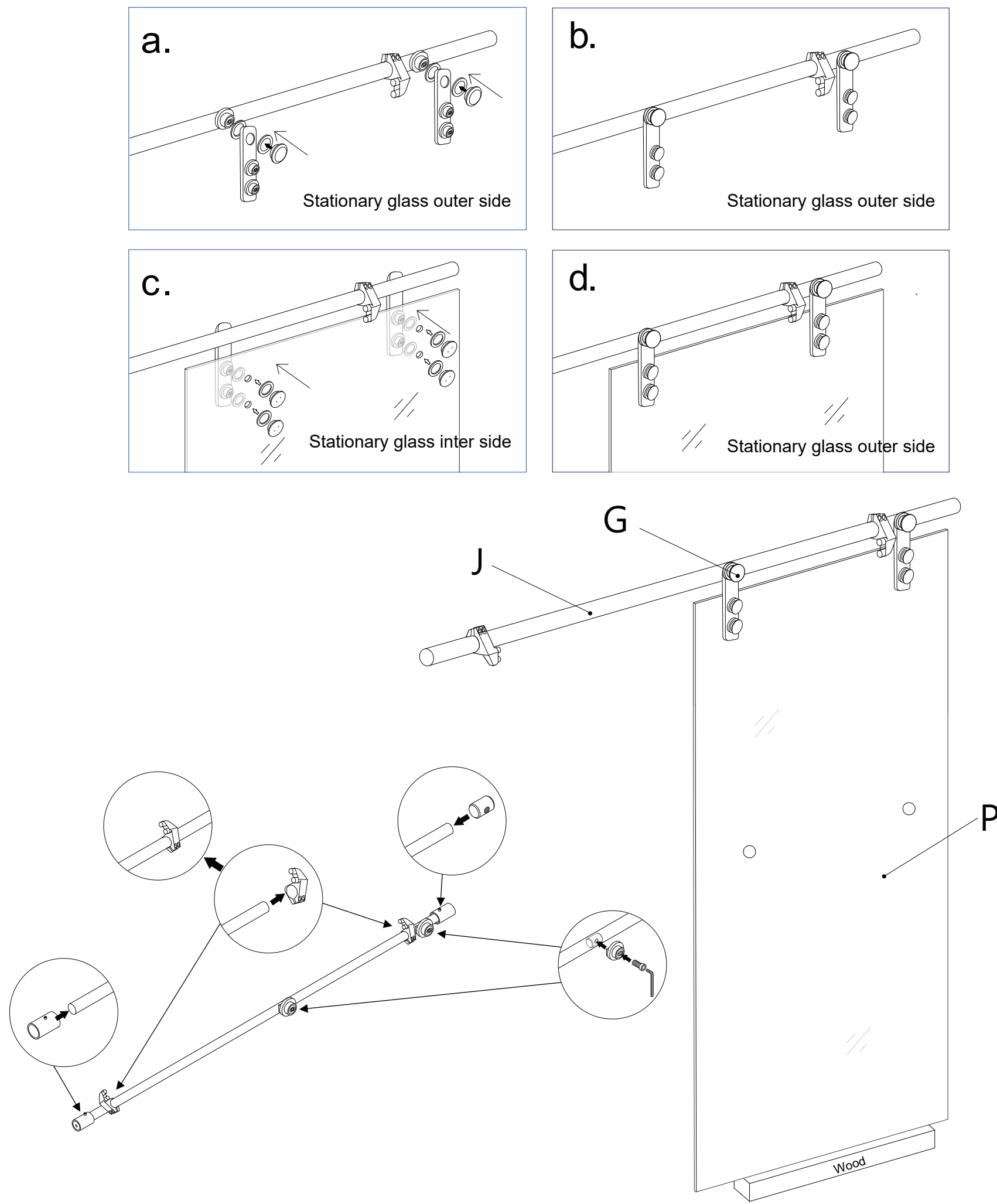

## Step 02

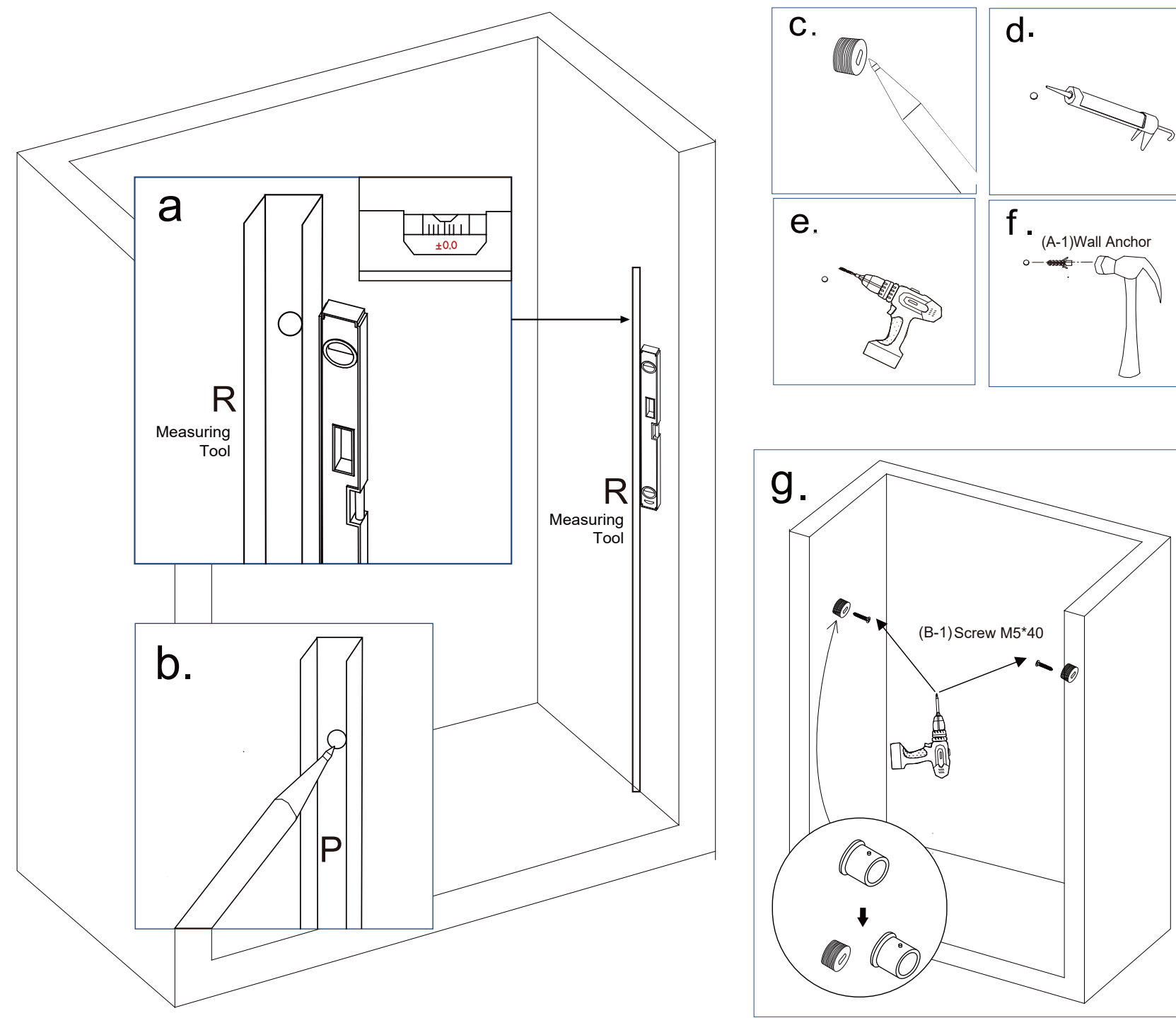

## Step 03

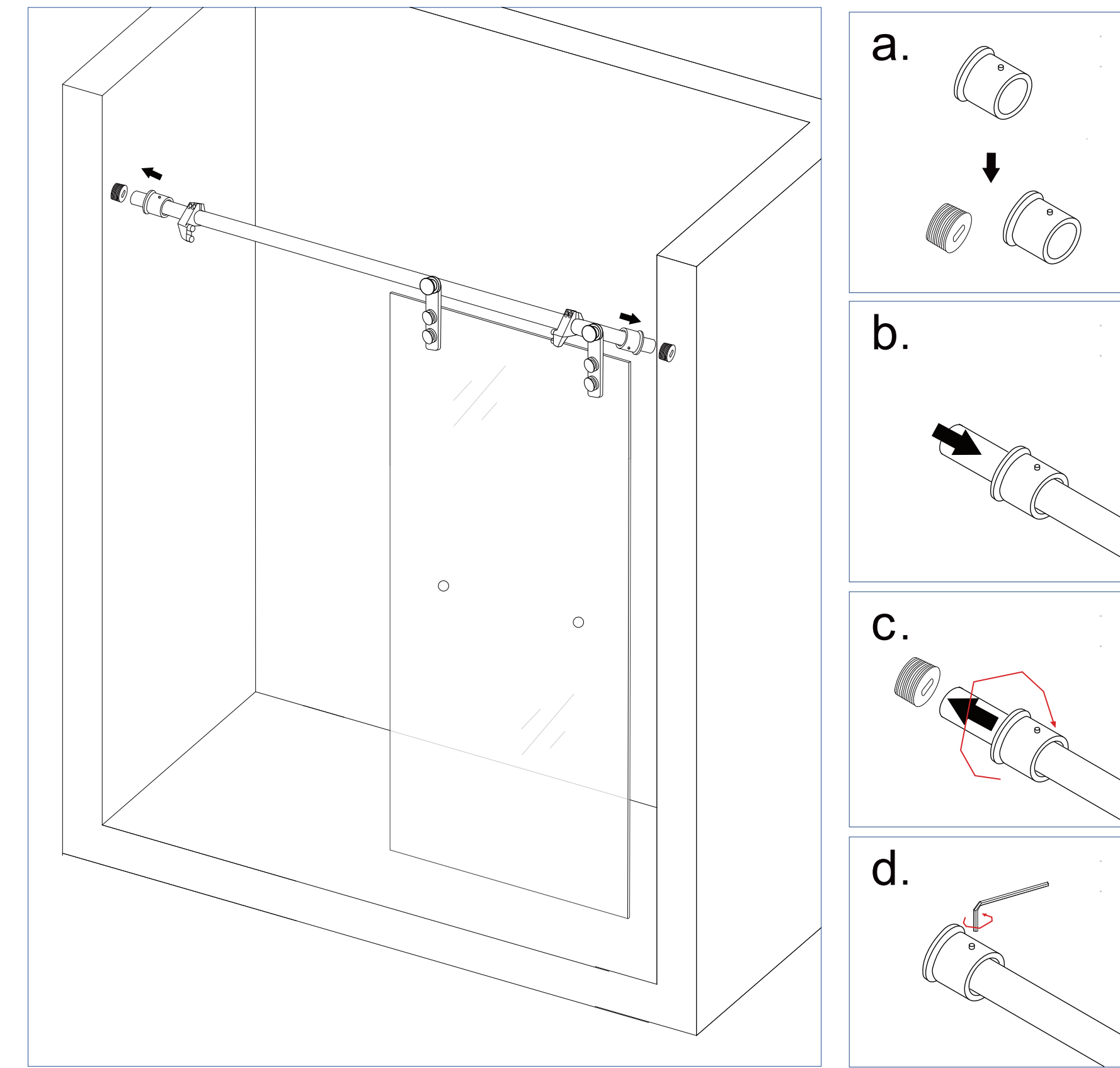

## Step 04

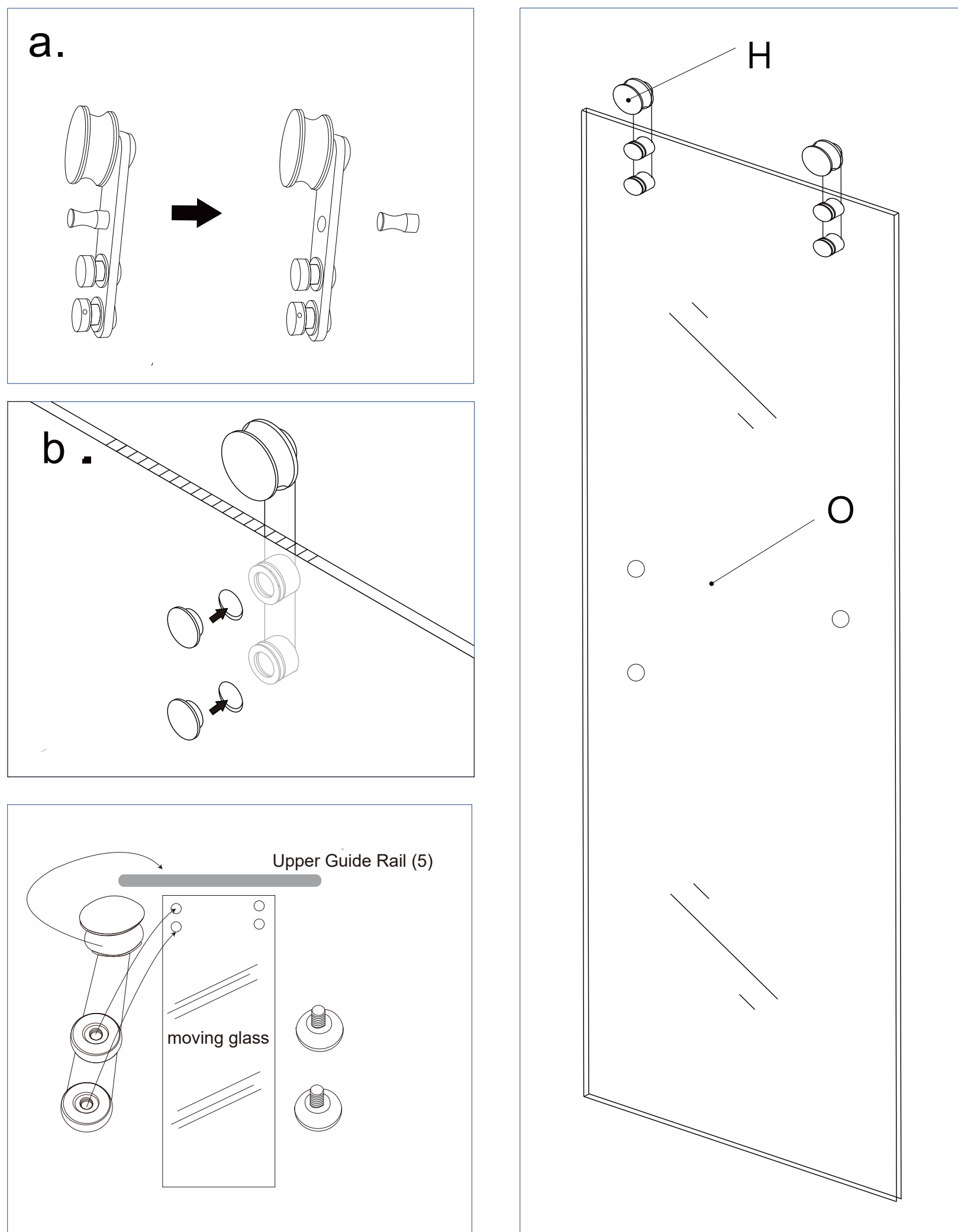

## Step 05

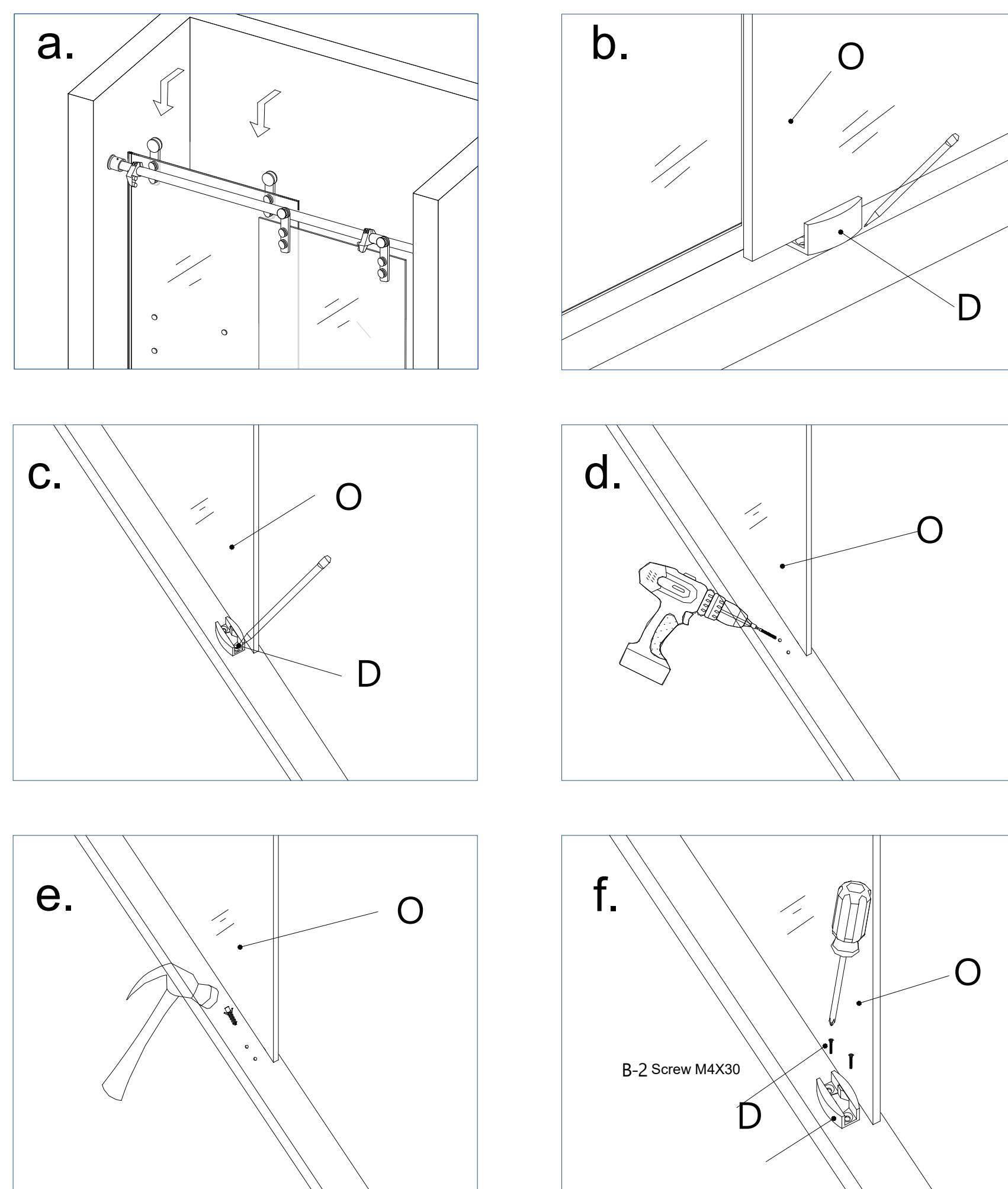

## Step 06

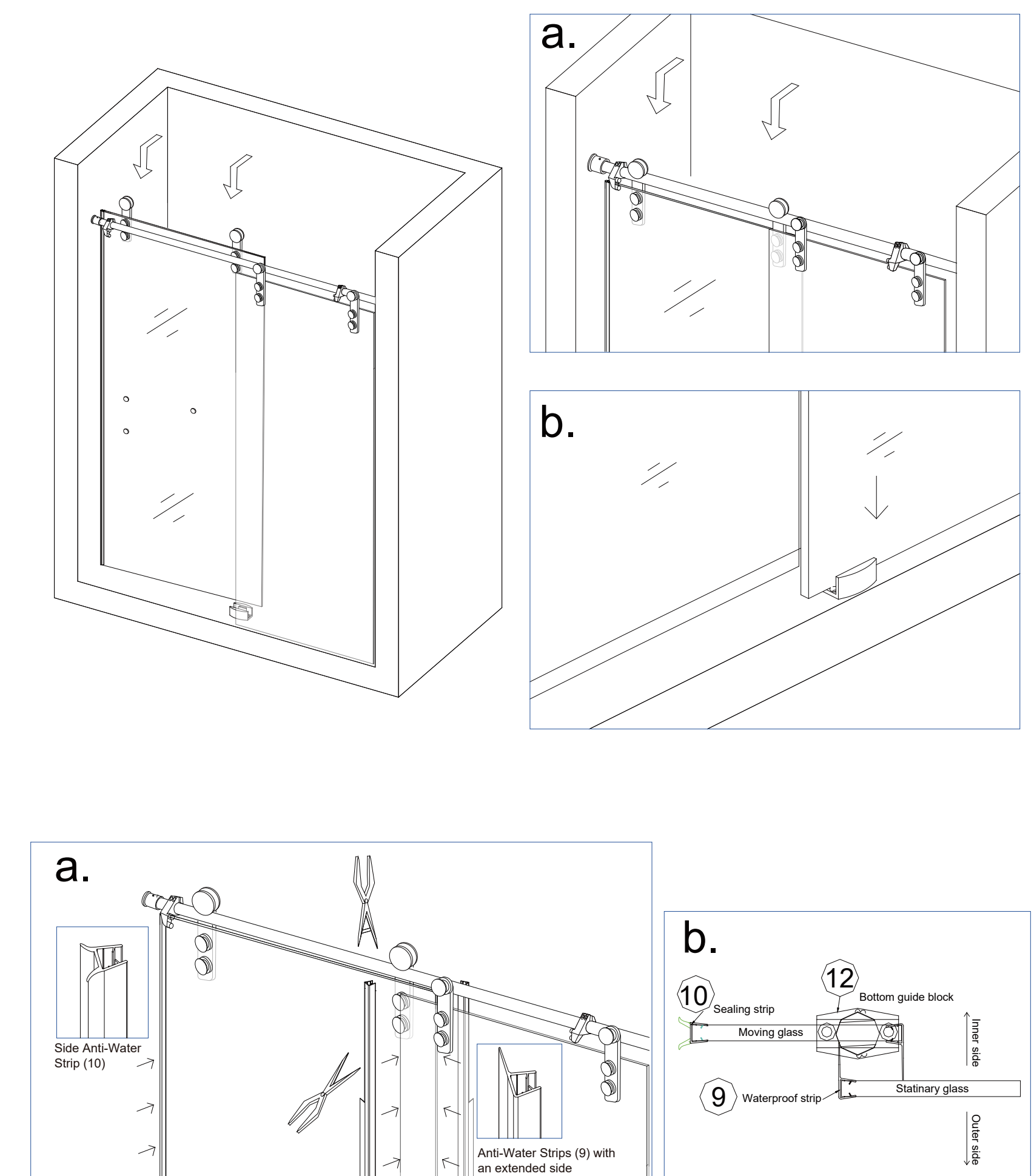

## Step 07

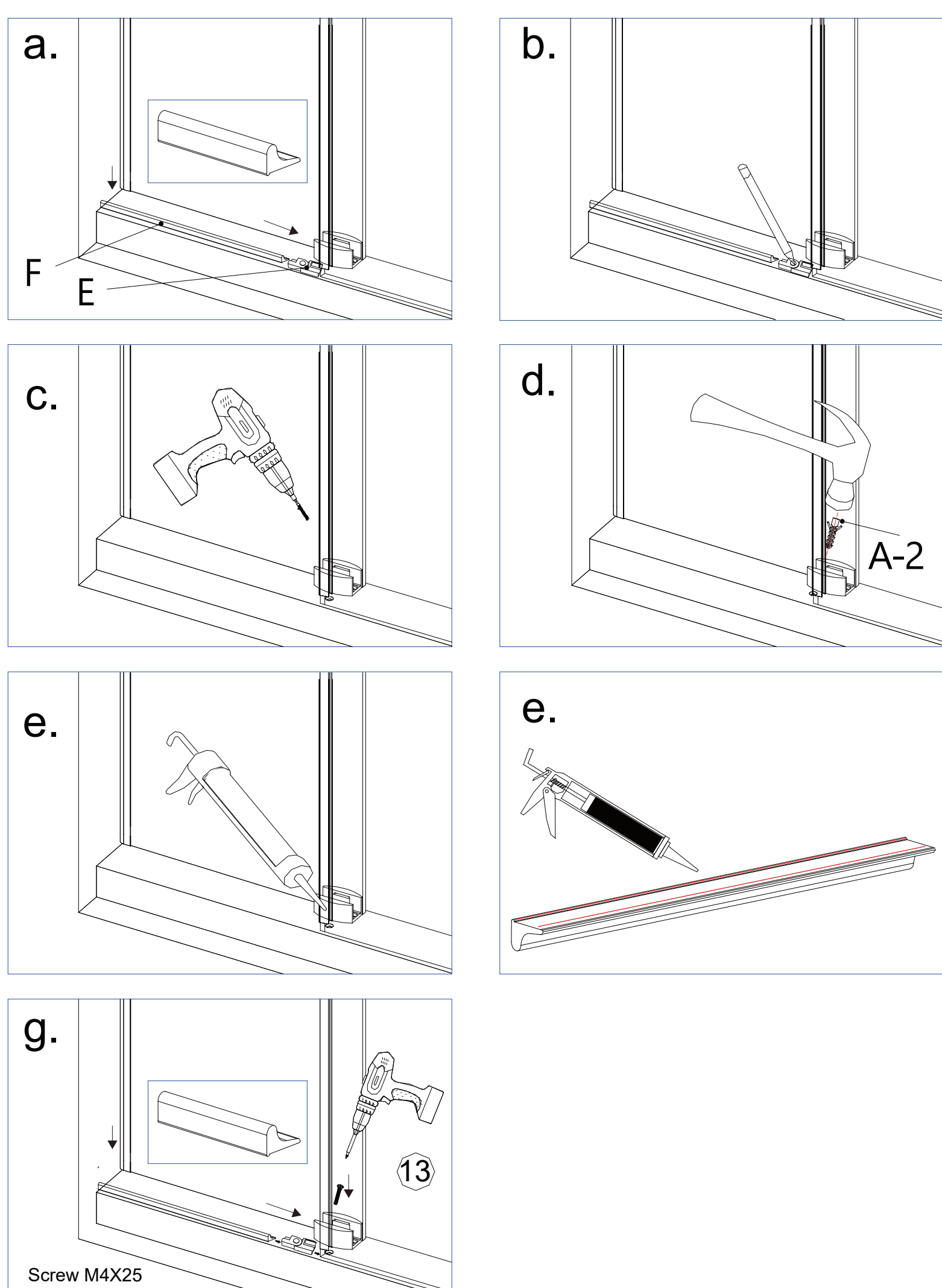

## Step 08

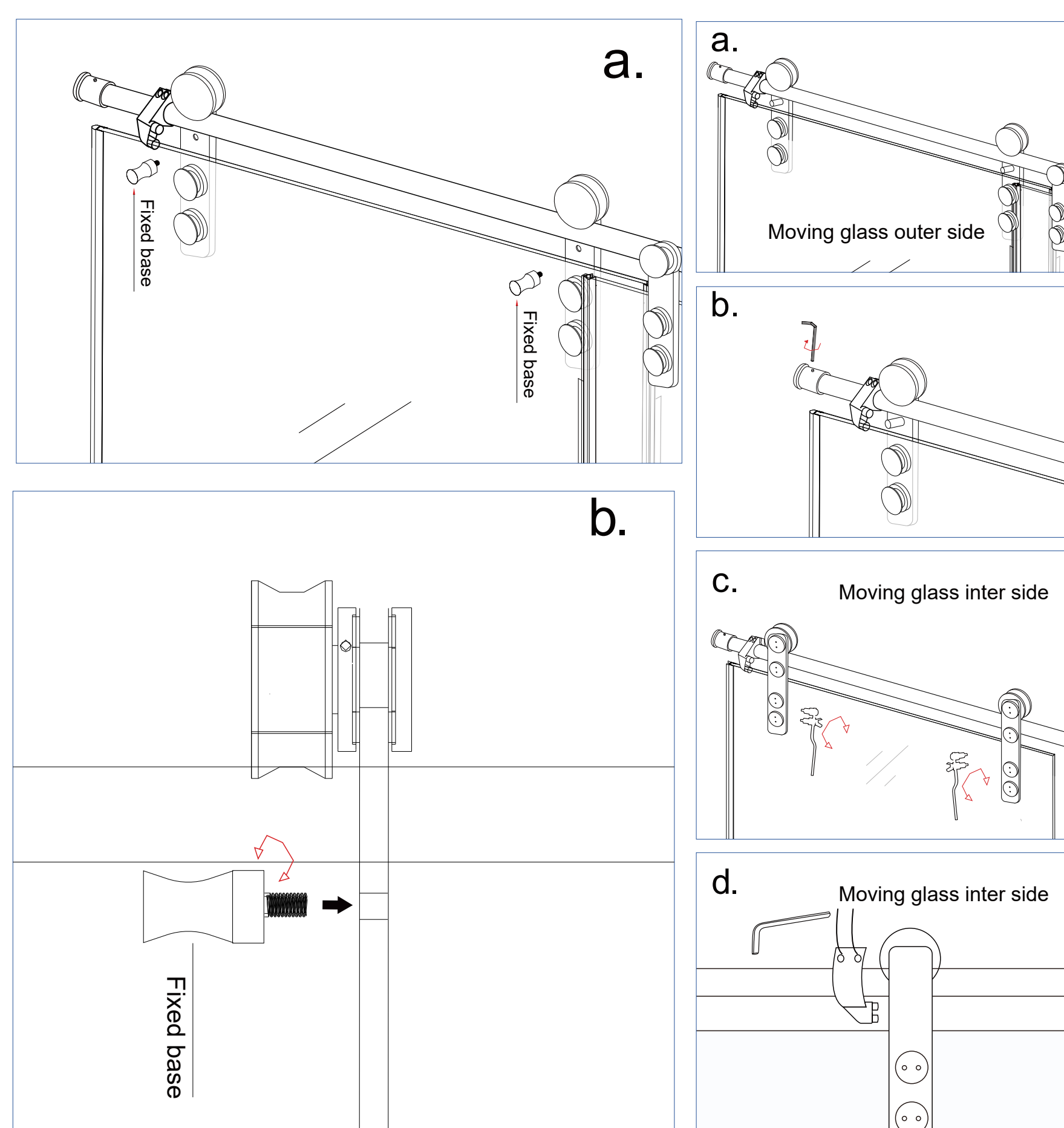

## Step 09

