

Kids Playset with Double Slide

USER MANUAL



READ AND SAVE THIS INSTRUCTION FOR FUTURE USE

SAFETY & WARNINGS

ADULT ASSEMBLY REQUIRED.

- Keep these instructions for future reference.
- This product is intended for indoor, outdoor, family, domestic use only.
- Place this product on level ground and at least 6.6' away from a fence, building, overhead branches, laundry lines or electrical wires. This product should be placed away from furniture that could cause injury if a fall occurs.
- Ensure the installation area is ventilated.
- Do not use the product if it is damaged or defective. If it is damaged or defective, please contact a qualified technician.
- Check that all parts are assembled well and are stable before use. Defective parts must be changed immediately as they can impair the function and the safety of the product.
- When temperatures fall below freezing (0°C/32°F), outdoor use of this product is not recommended. In extreme cold, plastic materials lose resilience and may become brittle and crack with impact. Store product in a warmer, protected place.
- Keep away from fire or any source of ignition.
- Packing materials are not toys, keep them away from children.
- Instruct children on proper use of this product: only after properly assembled and installed, and not in a manner other than intended.
- Dress children appropriately: do not allow children to wear loose-fitting clothing including ponchos, scarves and garments with drawstrings. Well-fitting shoes must be worn at all times.
- Avoid placing equipment in direct sunlight as hot surfaces could cause serious burns.
- Provide adult supervision at all times.

















PLEASE DO NOT RETURN TO STORE















**Please do not return this product to the retailer!!
We are able to assist you in ANY way**

If you find that you have any trouble with assembly or missing or damaged parts please contact the seller.

Part List

 ① 3PCS	 ② 2PCS	 ③ 2PCS	 ④ 2PCS
 ⑤ 4PCS	 ⑥ 4PCS	 ⑯ 1PC	 ⑧ 2PCS
 ⑨ 2PCS	 ⑩ 4PCS	 ⑪ 4PCS	 ⑫ 2PCS
 ⑬ 1PC	 ⑭ 2PCS	 ⑰ 2PC	 ⑱ 1PC

Part List

 A 7PCS	 B 36PCS	 C 56PCS	 D 4PCS
 E 4PCS	 F 1PC	 G 1PC	 H 1PC
 M 4PC	 J 1PC	 P 1PC	 Q 1PC

① ASSEMBLY

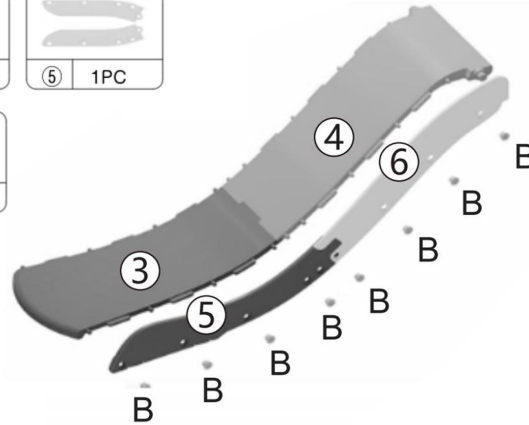
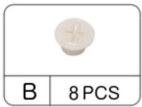
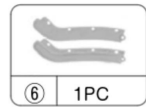
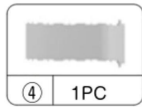
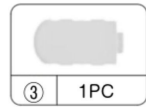

STEP1

Connect Part ③, ④, ⑤, ⑥ together as shown, and secure with 8pcs Screw B.

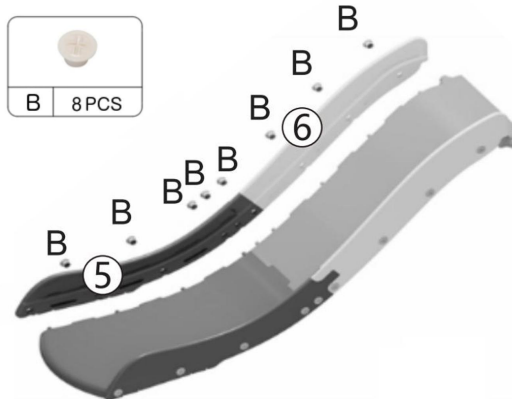
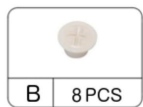
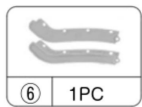
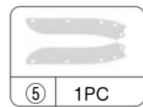

STEP2

Connect the Part ⑤ to Part ⑥. Then attach the assembled parts to the STEP 1 assembled parts, secure with 8 Screw B

① ASSEMBLY



STEP 3

Secure with 2 Screw D to the handrail of the slide from inside. Then Secure with 2 Screw B from outside.

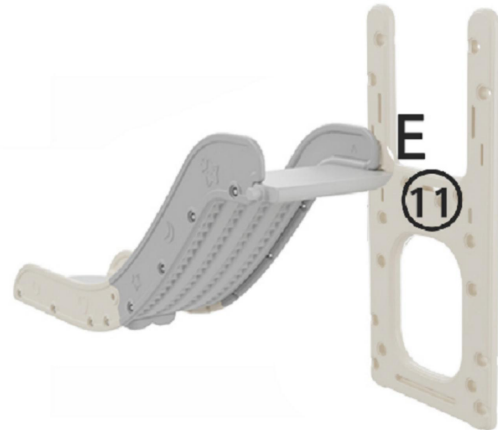
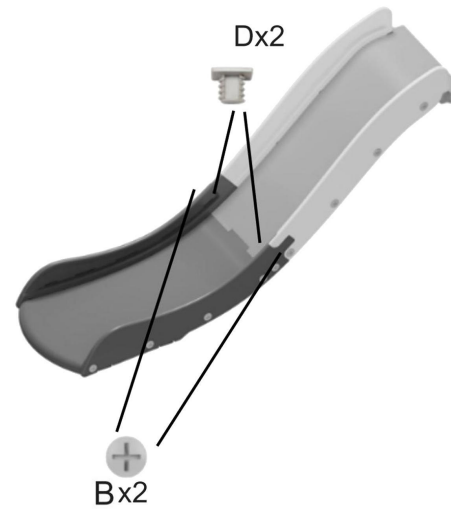

STEP 4

Connect the Part ⑪ to the STEP 3 assembled parts, secure with Screw E.

ASSEMBLY

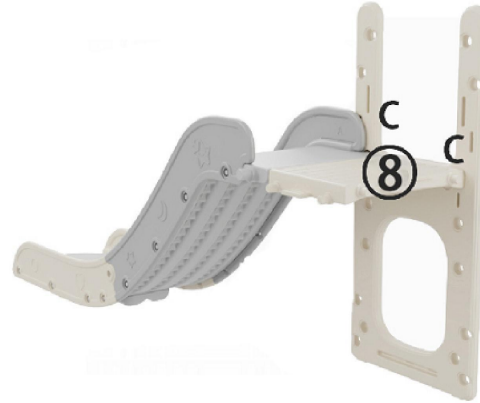
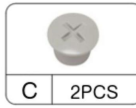

STEP5

Connect the Part ⑧ to the Part ⑪, secure with 2 Screw C.

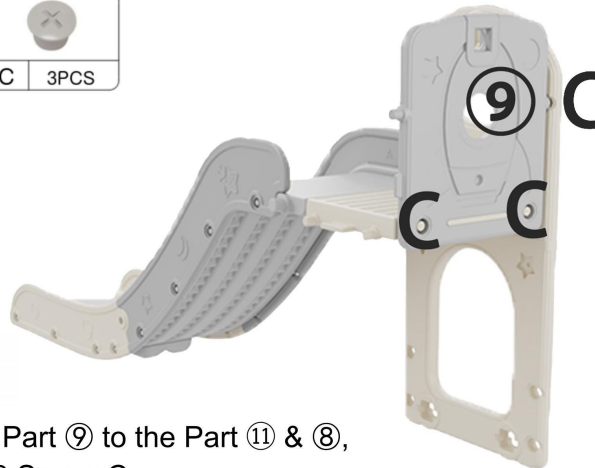
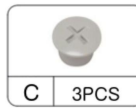
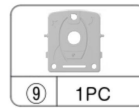

STEP6

Connect the Part ⑨ to the Part ⑪ & ⑧, secure with 3 Screw C.

ASSEMBLY

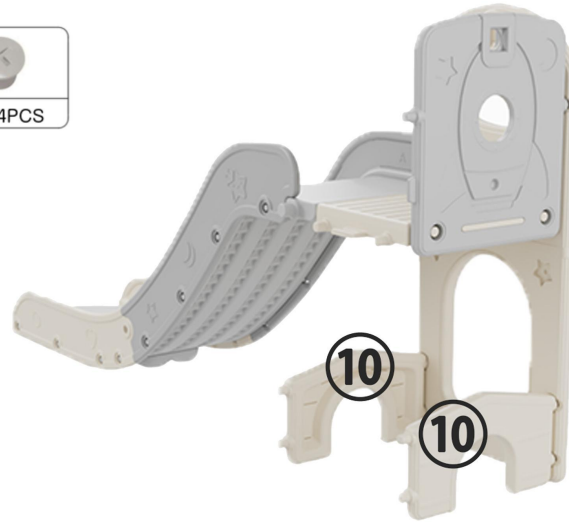

STEP7

Connect the 2 Part ⑩ to the Part ⑪, secure with 4 Screw C.



STEP8

Connect the Part ⑪ to the STEP 7 assembled parts, secure with 7 Screw C and Screw F



ASSEMBLY

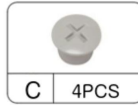
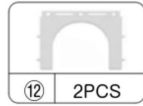

Note: The 2 sides of Part 12 are different. The concave side always faces inward.

STEP9

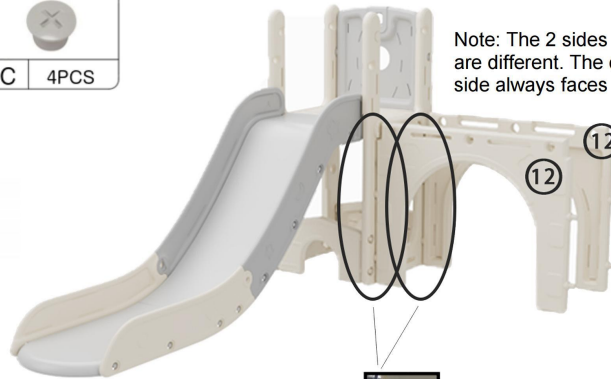

Connect the 2 Part ⑫ to the STEP 8 assembled parts, secure with 4 Screw C. For better stability, the space around the screw hole is rather tight with limited vertical clearance. Push the screw in first, and then use a screw hat to twist the screw.

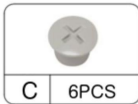
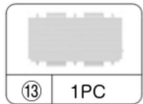
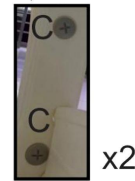

STEP10



Connect the Part ⑬ to the STEP 9 assembled parts, secure with 6 Screw C.

ASSEMBLY



STEP11

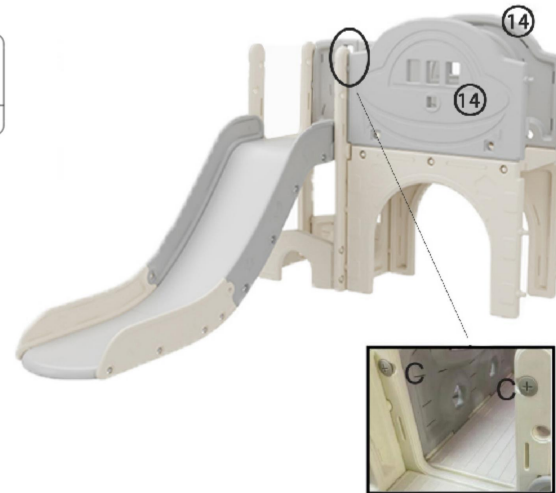

Connect the 2 Part ⑭ to the STEP 10 assembled parts, secure with 2 Screw C.
Note: The 2 sides of Part 14 are different.
The concave side always faces inward.

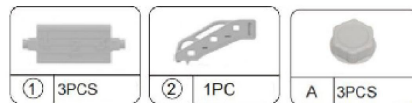

STEP12

Connect the 3 PCS Part ① to the Part ②, secure with 3 Screw A.

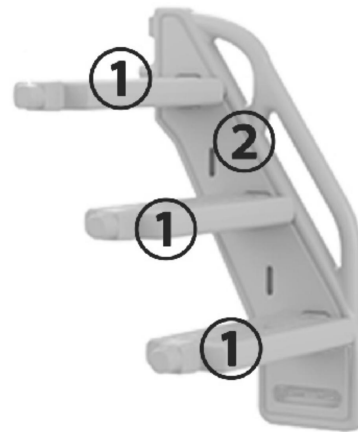

ASSEMBLY

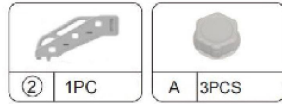

STEP13

Connect the other Part ② to the STEP 12 assembled parts, secure with 4 Screw A.

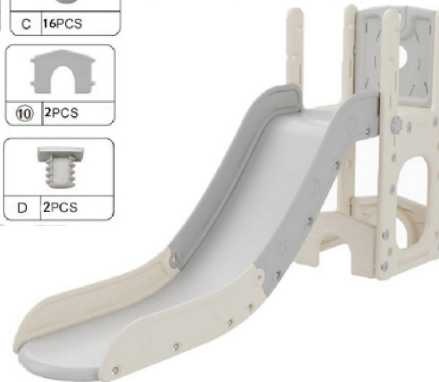
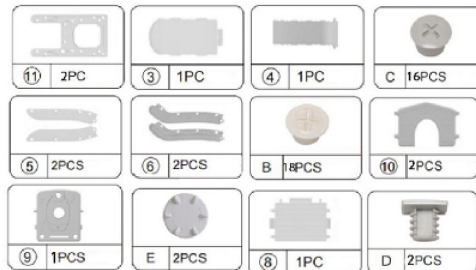

STEP14

Repeat Step 1 to Step 8.

① ASSEMBLY

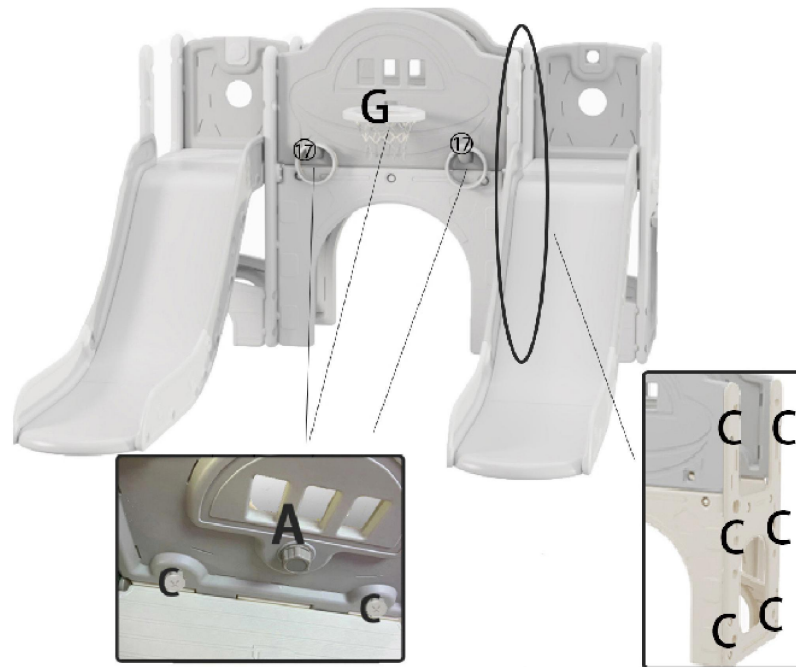

STEP15

1. Connect the STEP 14 assembled parts to the STEP 11 assembled parts, Secure with 6 Screw C.
2. Connect the 2 Part 17 to Part 14, Secure with 2 Screw C.
3. Tie the Part H to the Part G, then connect the Part G to the Part 14, Secure with Screw A.

ASSEMBLY

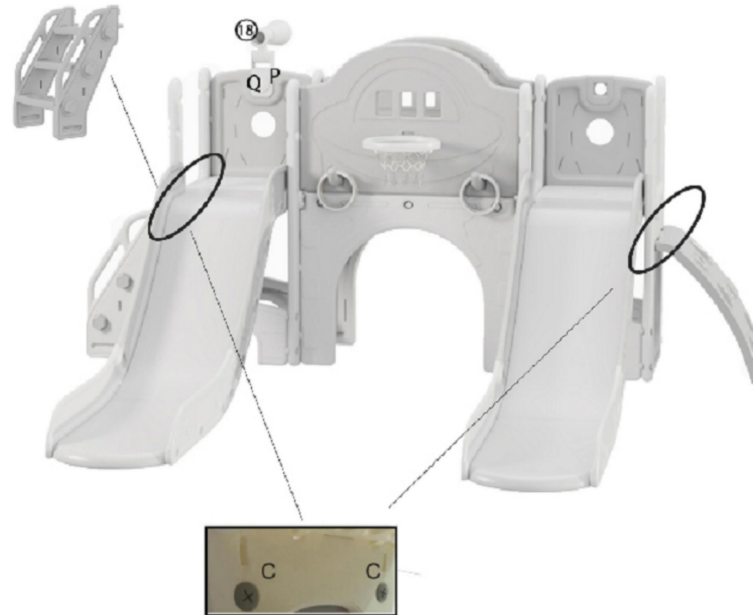
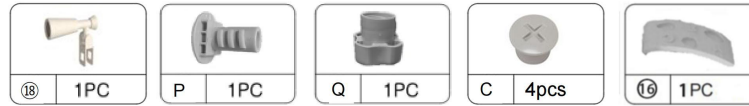

STEP16

1. Connect the STEP 13 assembled parts to the STEP 15 assembled parts, Secure with 2 Screw C.
2. Connect the Part 16 to STEP 15 assembled parts, Secure with 2 Screw C.
3. Connect the Part 18 to the Part 9, Secure with Screw P&Q.



GENERAL SAFETY INSTRUCTIONS

This product is intended for indoor, outdoor, home, domestic use only. It is not suitable for commercial or medical use.

The assembly of the product must be done carefully and by an able-bodied adult. If in any doubt, ask a technically qualified person.

Do not use the product if it is damaged or defective. If it is damaged or defective, please contact a qualified technician.

Check the product before each use. Defective parts must be changed immediately as they can impair the function and the safety of the product.

Use the product only on even and non-slip surfaces. Keep sufficient space around for safety.

Beware that when using tools or doing technical work, there is always a risk of injuries. Assemble the product with care.

After installing the product according to the instruction manual, ensure all screws, bolts and nuts are correctly installed and tightened and that all joints are secure.

Do not make alterations to the product. Only use original spare parts. Only qualified technicians should carry out repairs - improper repairs can lead to danger for the user. Use this product only as described in this manual.

IMPORTANT

The owner's manual contains safety, assembly, use and maintenance instructions. The product must be assembled by an adult who has read and understood these instructions. Keep the packaging away from children and dispose of all packaging before use.

OPERATION INSTRUCTIONS

Provide adult supervision at all times.

The disassembled product contains small parts which pose a choking hazard to children under 3.

Dress children appropriately, including wearing well-fitting shoes that fully protect feet.

Instruct children:

- to sit in the center of the swings with their full weight on the seats,
- to avoid swinging empty seats,
- to slide feet first; one child down slide at a time,
- to remove articles, before playing on equipment, that create hazards when they get tangled and caught.
- not to walk close to, in front of, behind, or between moving items,
- not to get off equipment while it is in motion.

Never allow children to use the equipment in a manner other than intended. Do not swing while standing or slide down head first.