

ASSEMBLY INSTRUCTIONS

30 INCH BATH VANITY

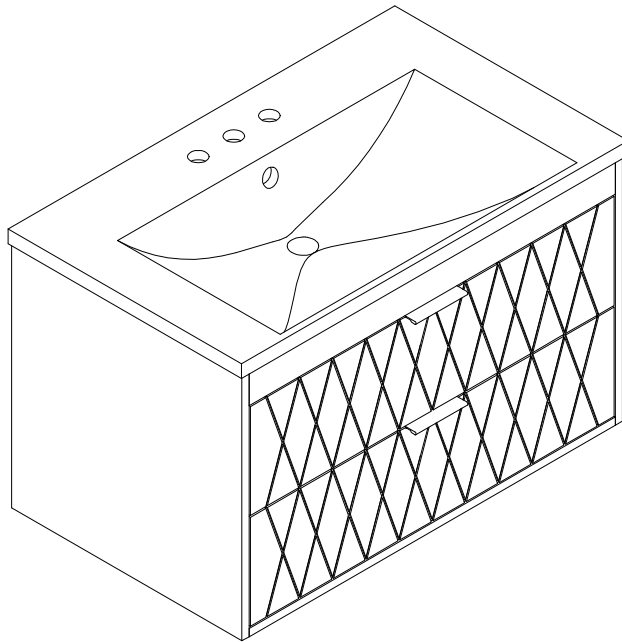

Thank you for purchasing this quality product. Be sure to check all packing material carefully for small parts which may have come loose inside the carton during shipment. Separate, identify and count all parts and hardware. Compare with the parts list to be sure all parts are present.
"DO NOT TIGHTEN SCREWS UNTIL COMPLETELY ASSEMBLED"

*** Use of power tool to assemble this product will invalidate any claim and damage this product making unsafe !!!**
*** Please assemble on a clean soft surface to avoid damage.**

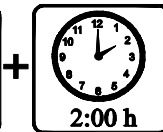
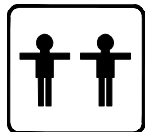

Tools Required

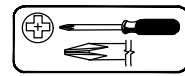

(Not included)

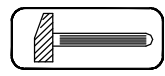

(Not included)

IMPORTANT:

PLEASE READ INSTRUCTION BEFORE STARTING THE ASSEMBLY

PLEASE DO NOT RETURN TO STORE



**Please do not return this product to the retailer!!
We are able to assist you in ANY way**

If you find that you have any trouble with assembly or missing or damaged parts please contact the seller.

Before Installation

Important – Please read these instructions fully before starting assembly

Thank you for purchasing this quality product. Be sure to check all packing materials carefully for small parts, which may have come loose inside the carton during shipment. Identify and count all items according to the PARTS LIST and/or HARDWARE LIST shown below. Check you have all the components and tools listed on the following pages.

- We recommend that you assemble this product with the assistance of another person; this will make the assembly easier, and will help eliminate damage to the product or injury to persons during assembly.
- Please do not over tighten screws or bolts until the assembly is completed.
- Keep children and animal away from the work area, small parts could choke if swallowed.
- Please put all parts on a non-abrasive floor before assembly, and follow the assembly steps to assemble your newly purchased product correctly and efficiently.

Cam Lock Assembly Instructions

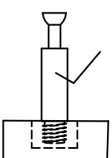
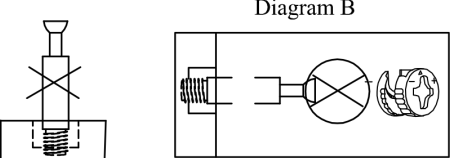
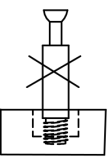
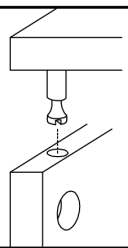
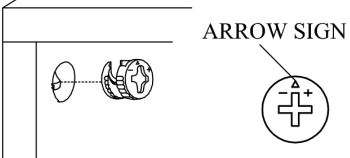
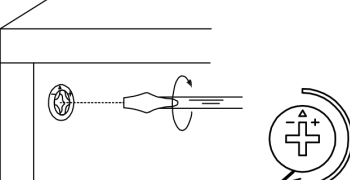
	<p>Diagram A</p>	<p>Insert Cam Bolt into hole as shown in diagram A.</p>
	<p>Diagram B</p>	<p>Make sure not to insert the Cam Bolt: Too deep as shown in figure B as this will cause the Cam Lock to be misaligned and unable to interlock properly.</p>
	<p>Diagram C</p>	<p>Also avoid inserting the Cam Bolt too close to the surface of the hole as shown in figure C, as this will cause the Cam Lock to be too loose, and not interlock properly.</p>
		<p>Connect the panels together.</p>
	<p>ARROW SIGN</p>	<p>Insert the Cam Lock so the side opening fits over the head of the Cam Bolt.</p>
		<p>To tighten the Cam Lock, turn it clockwise on half a turn with a flat screwdriver. <i>*Do not use an automatic screwdriver as it may bend or break if too much power is imposed.</i></p>

Before installing the slide, separate the cabinet member and the drawer member.

**Pay attention when connecting !
The sliding module must be at the front end.**

STEP 1 : Extend Slide

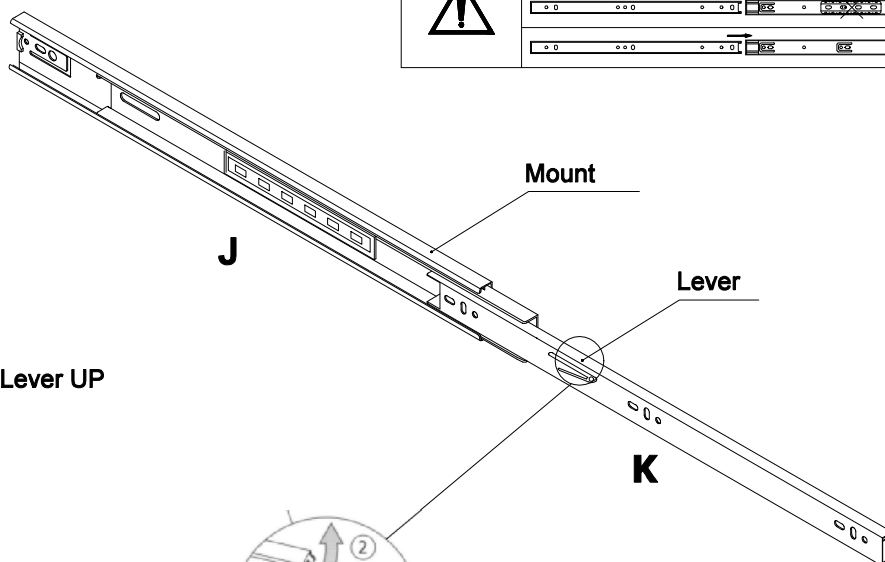
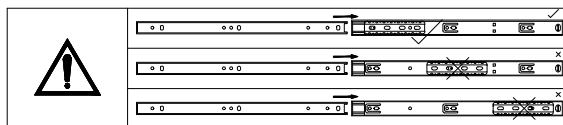

STEP 2: Push Lever UP



**Push lever for the left of drawer ,
press the lever for the right of drawer.**

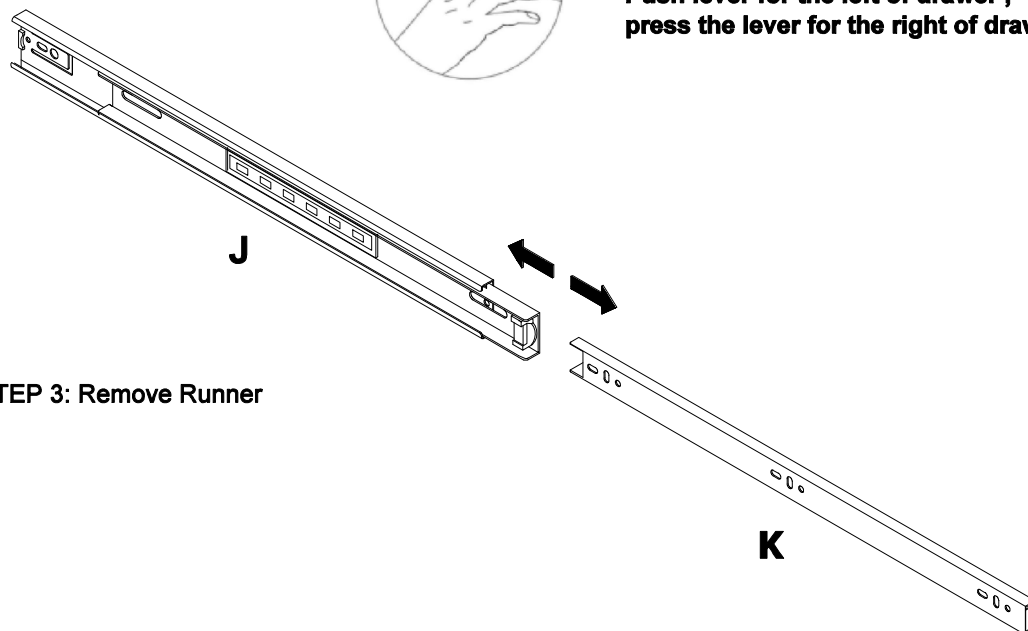

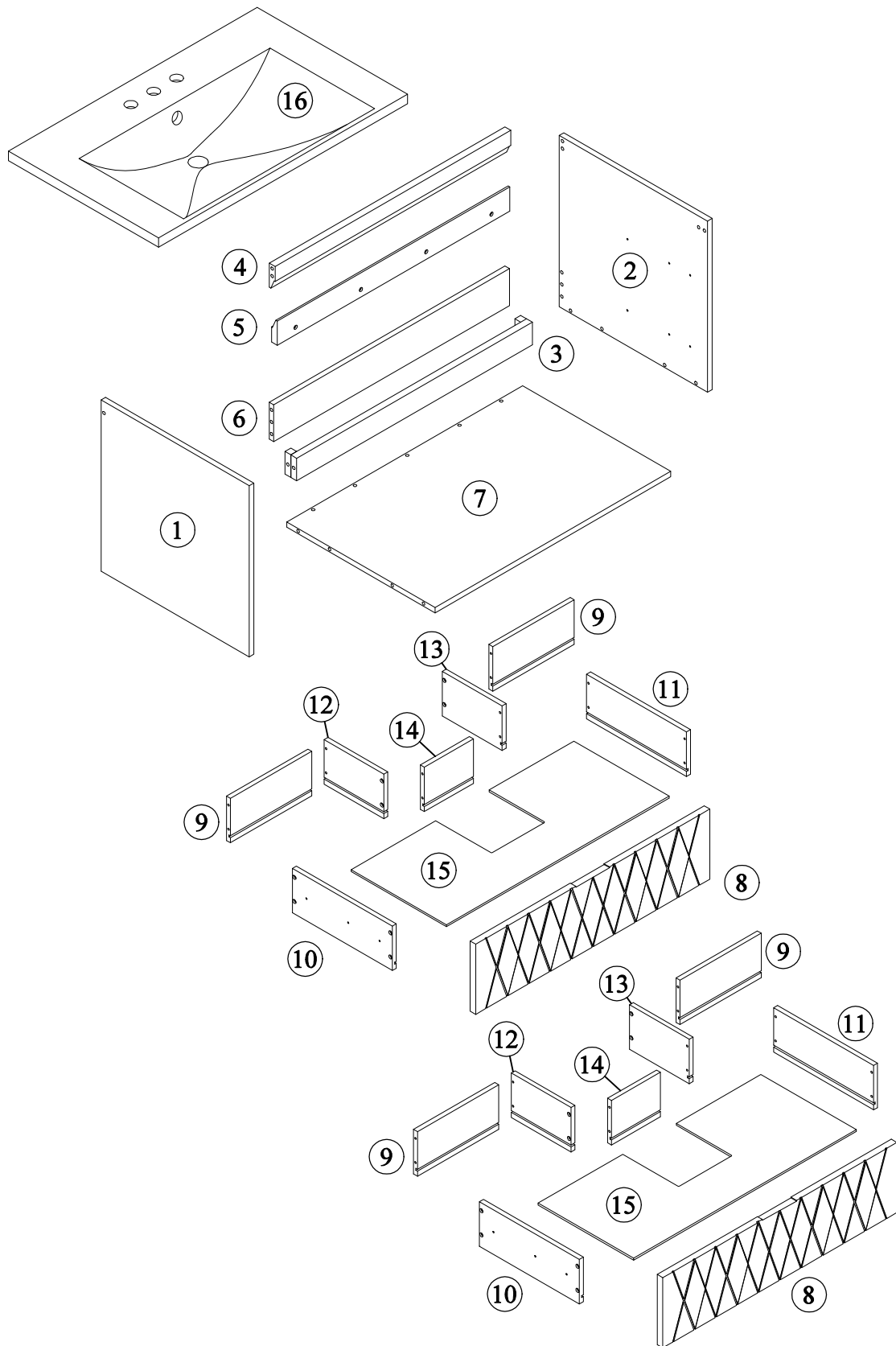

STEP 3: Remove Runner

Detail View - CABINET





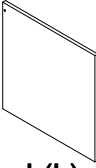
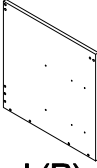
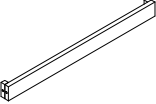
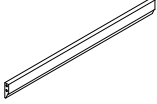
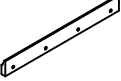
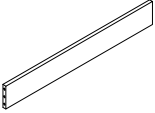
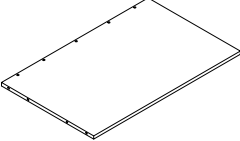
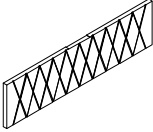
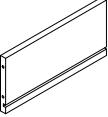
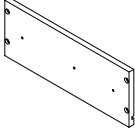
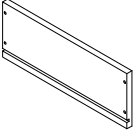
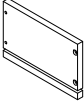
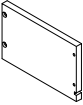

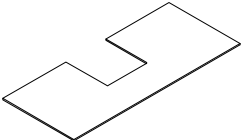
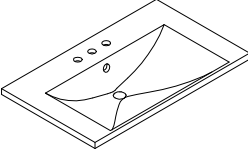



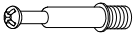

Identifying the Hardware-Identify the hardware using the illustrations below.

Part List - WF316723

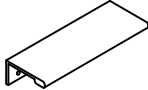
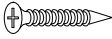
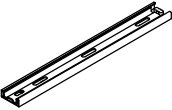
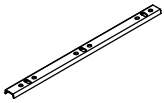
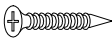
<p>1</p>  <p>Side Panel (L) - 1pc</p>	<p>2</p>  <p>Side Panel (R) - 1pc</p>
<p>3</p>  <p>Top Crossbar Front - 1pc</p>	<p>4</p>  <p>Top Crossbar Rear - 1pc</p>
<p>5</p>  <p>Connect Bar - 1pc</p>	<p>6</p>  <p>Bottom Panel Rear - 1pc</p>
<p>7</p>  <p>Bottom Panel - 1pc</p>	<p>8</p>  <p>Top Drawer Face - 2pcs</p>
<p>9</p>  <p>Drawer Rear - 4pcs</p>	<p>10</p>  <p>Drawer Panel Side (L) - 2pcs</p>
<p>11</p>  <p>Drawer Panel Side (R) - 2pcs</p>	<p>12</p>  <p>Mid Drawer Side (L) - 2pcs</p>
<p>13</p>  <p>Mid Drawer Side (R) - 2pcs</p>	<p>14</p>  <p>Mid Drawer Panel - 2pcs</p>
<p>15</p>  <p>Bottom Drawer Panel - 2pcs</p>	 <p>Sink - 1pc</p>

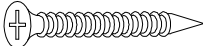
Hardware List - WF316723

<p>A</p>  <p>$\varnothing 13 \times 1/4" \times 28 \text{mm}$</p>	<p>B</p>  <p>$\varnothing 13 \times 1/4" \times 50 \text{mm}$</p>	<p>C</p>  <p>$\varnothing 1/4" \times 16 \times 1 \text{mm}$</p>
<p>Hex-Head bolts (2pcs)</p>	<p>Hex-Head bolts (2pcs)</p>	<p>Washer (2pcs)</p>
<p>D</p>  <p>$\varnothing 10 \times 13 \text{mm}$</p>	<p>E</p>  <p>$\varnothing 6 \times 35 \text{mm}$</p>	<p>F</p>  <p>$\varnothing 14.5 \times 12 \text{mm}$</p>
<p>Horizontal-Hole bolts(2pcs)</p>	<p>Three in one bolts (11pcs)</p>	<p>Three in one lock (11pcs)</p>
<p>G</p>  <p>$\varnothing 8 \times \varnothing 4 \times 32 \text{mm}$</p>	<p>H</p> 	<p>I</p>  <p>$\varnothing 7 \times \varnothing 3.5 \times 12 \text{mm}$</p>
<p>Round head screw (32pcs)</p>	<p>Handle (2pcs)</p>	<p>Flat head screw(6pcs)</p>
<p>J</p>  <p>$\varnothing 300 \times 35 \text{mm}$</p>	<p>K</p>  <p>$\varnothing 298 \times 18 \text{mm}$</p>	<p>L</p>  <p>$\varnothing 6 \times \varnothing 3 \times 12 \text{mm}$</p>
<p>Slide rails (4pcs)</p>	<p>Slide rails (4pcs)</p>	<p>Flat head screw (24pcs)</p>
<p>M</p>  <p>$\varnothing 8 \times 30 \text{mm}$</p>	<p>N</p>  <p>$\varnothing 10 \times \varnothing 5 \times 50 \text{mm}$</p>	<p>O</p>  <p>$\varnothing 12 \times 55 \text{mm}$</p>
<p>Wood dowel (12pcs)</p>	<p>Flat head screw - 4pcs</p>	<p>Plastic stopper - 4pcs</p>
<p>P</p>  <p>4mm</p> <p>Allen key (1pc)</p>		

STEP: 1

E

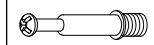

11PCS

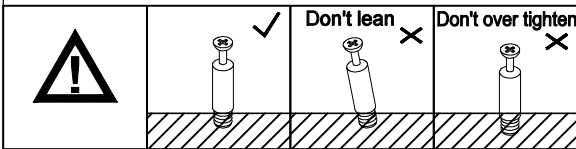
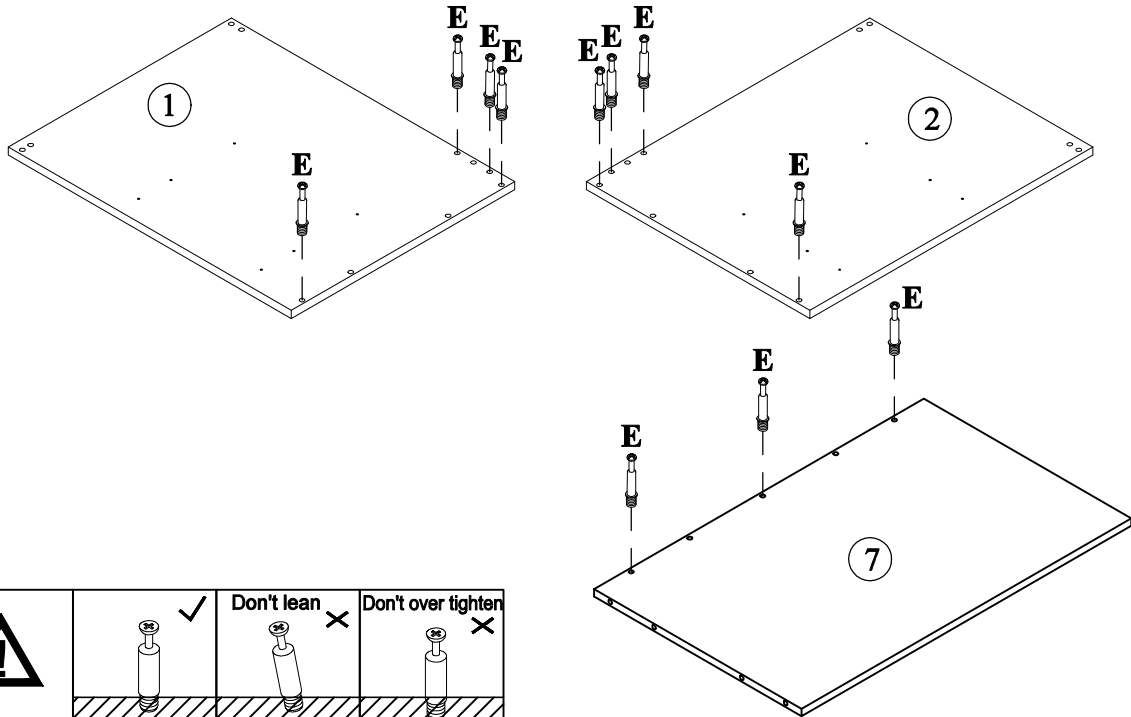

STEP: 2

J



4PCS

L



12PCS

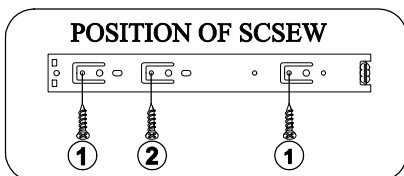
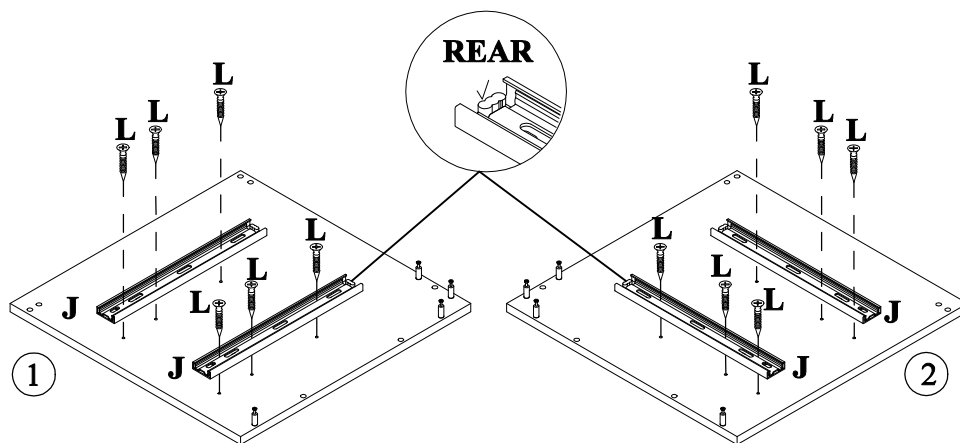



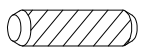

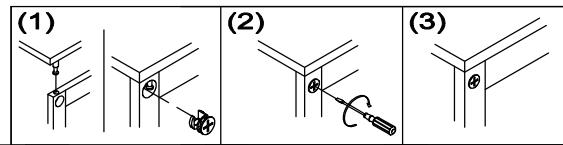
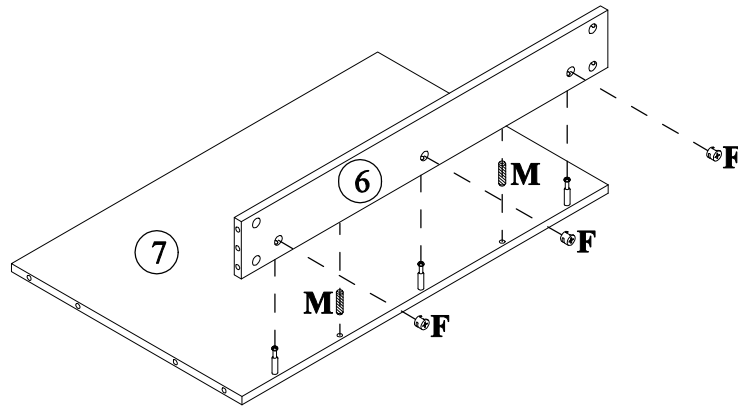
STEP: 3

F		M	
	3PCS		2PCS

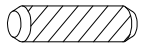

STEP: 4

A	B	C	D	M
				
1PC	1PC	1PC	1PC	2PCS

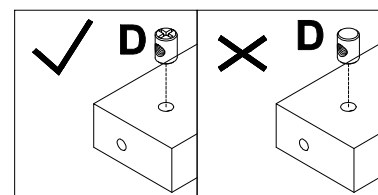
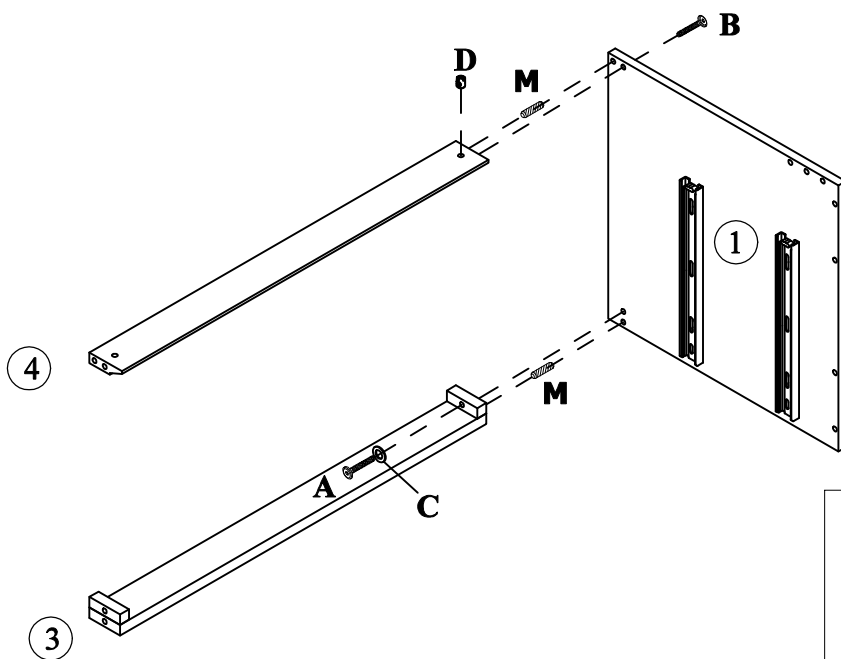



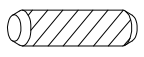

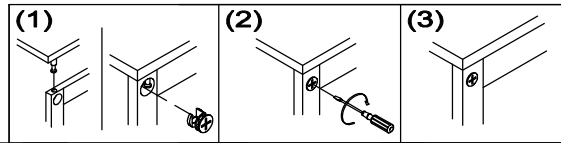
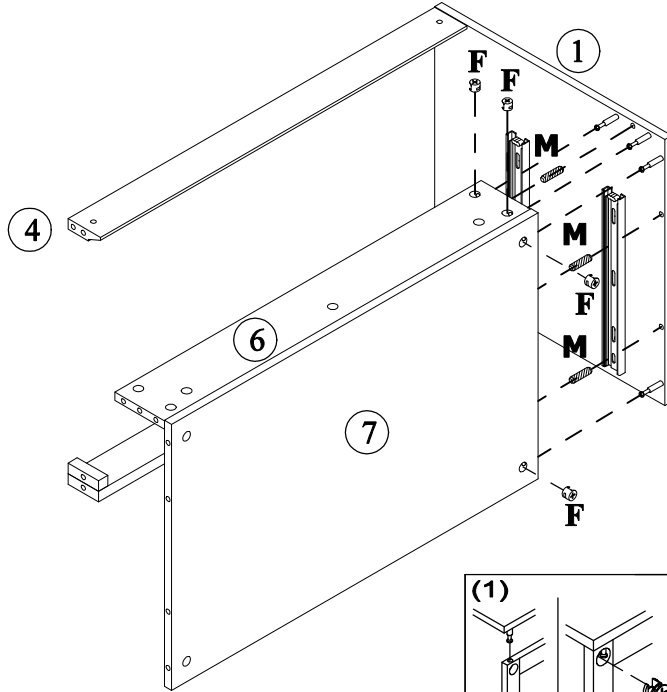
STEP: 5

F		M	
	4PCS		3PCS



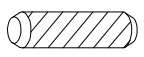

STEP: 6

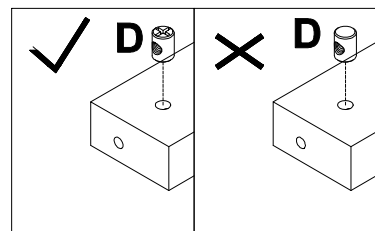
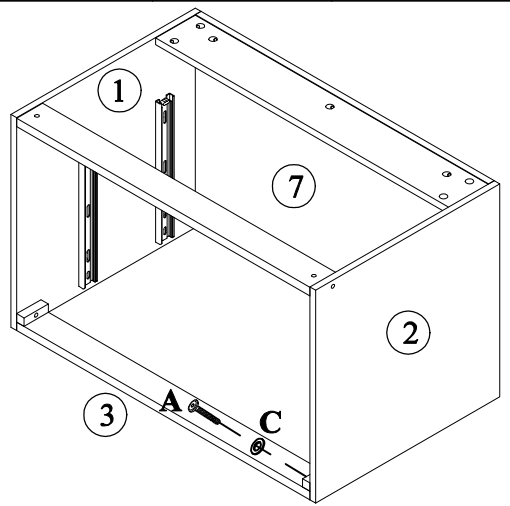
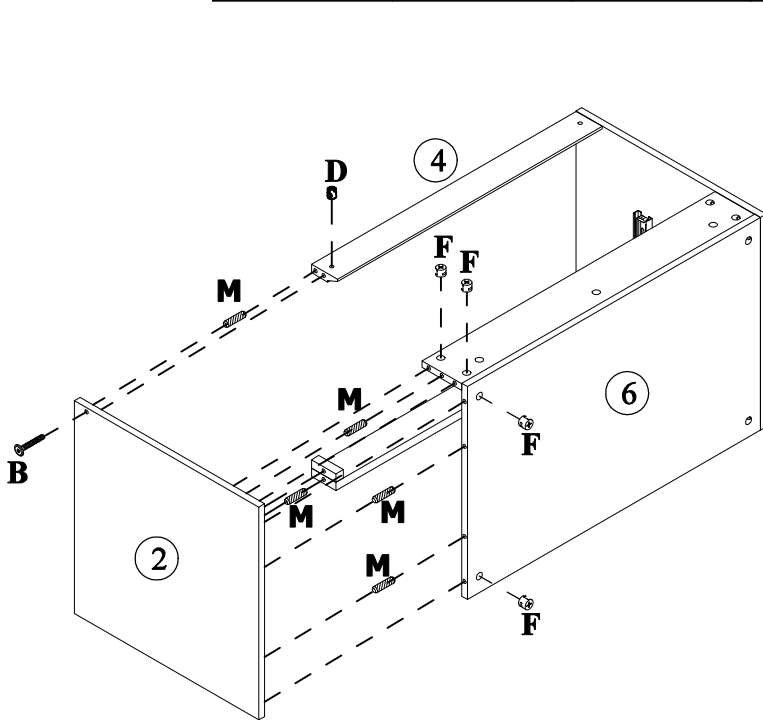
A		B		C		D		F		M	
	1PC		1PC		1PC		1PC		4PCS		5PCS

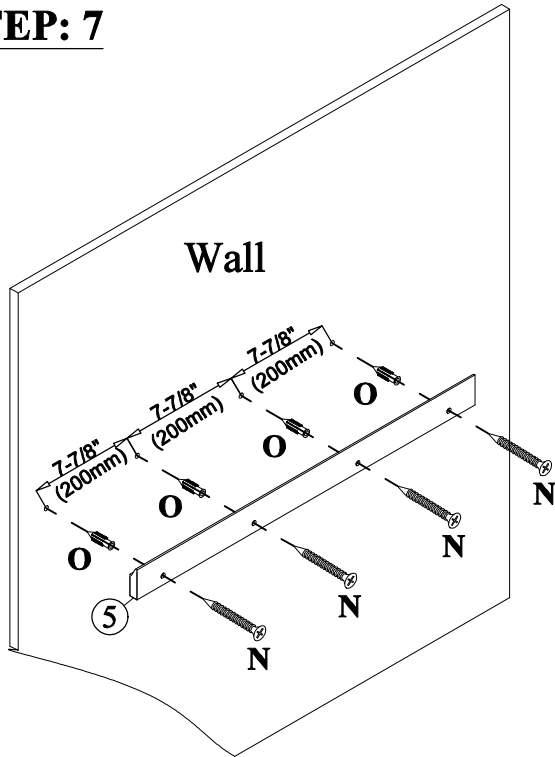

STEP: 7



N	O
	
4PCS	4PCS

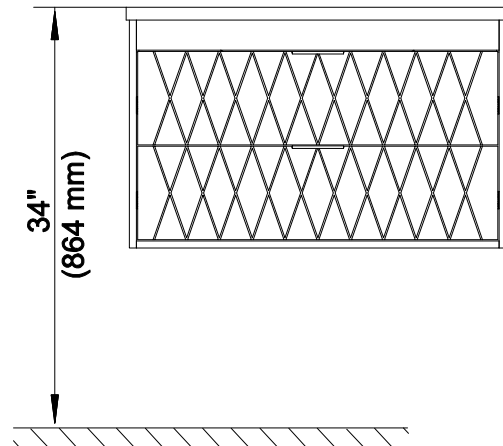

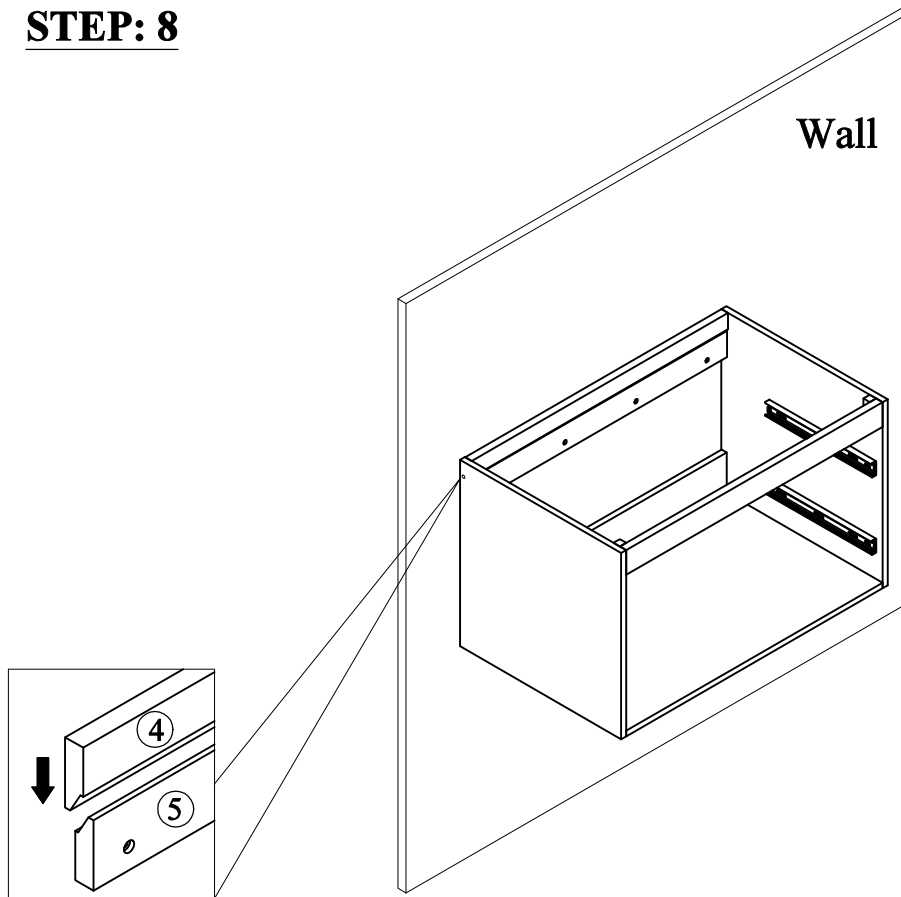

Draw the spacing between the walls and the No.5, punch holes in the wall, and fix the No.5 to the wall with screws.
Note: Appropriate distance from the top of sink to the ground is 34".

STEP: 8

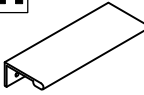
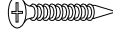
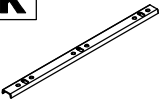

STEP: 9

G 	H 	I 	K 	L 
32PCS	2PCS	6PCS	4PCS	12PCS

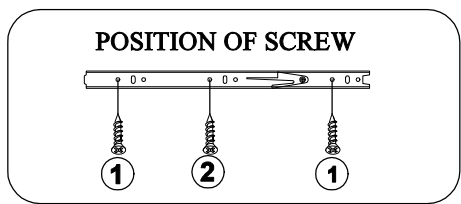
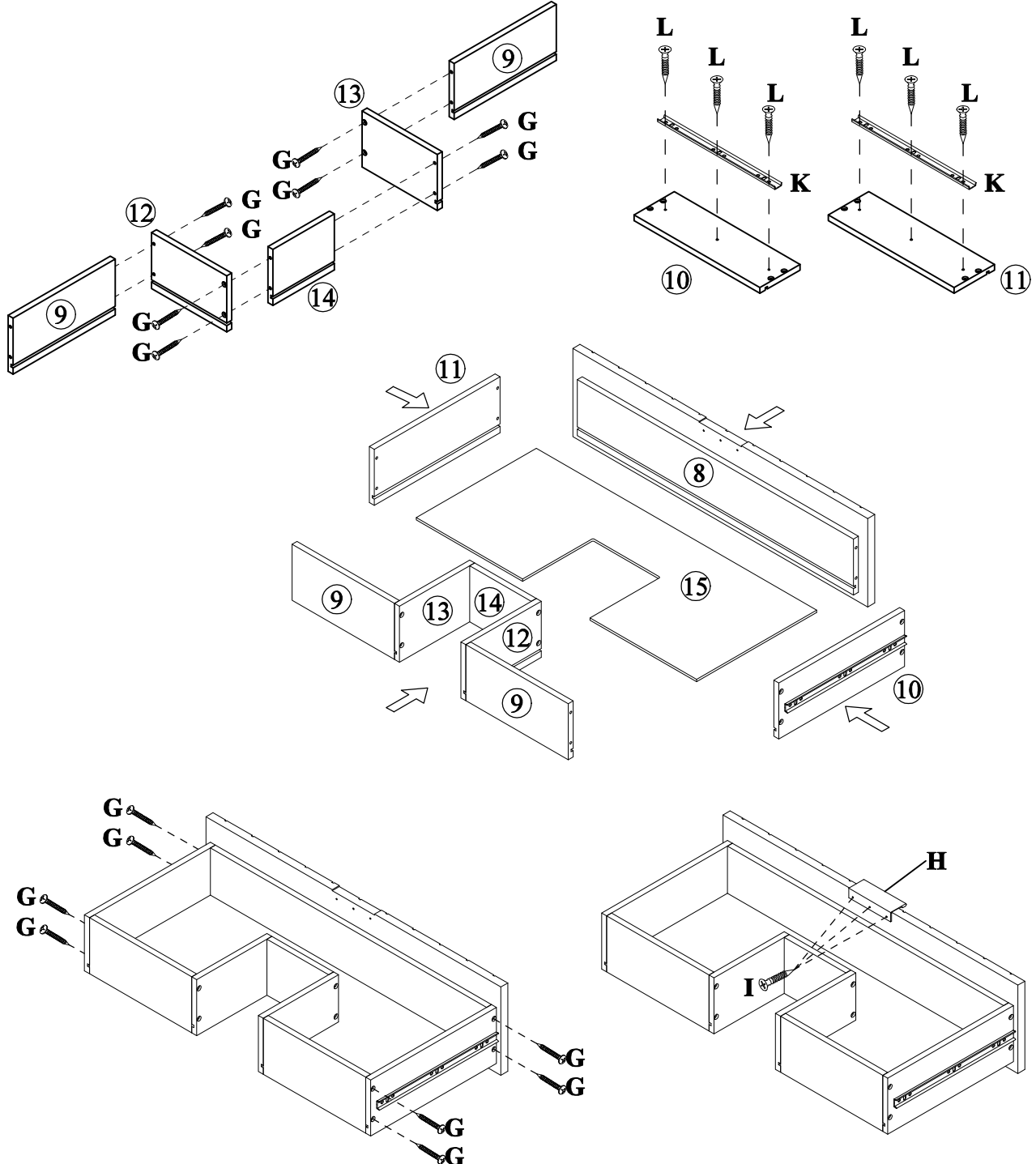

x2

STEP: 10

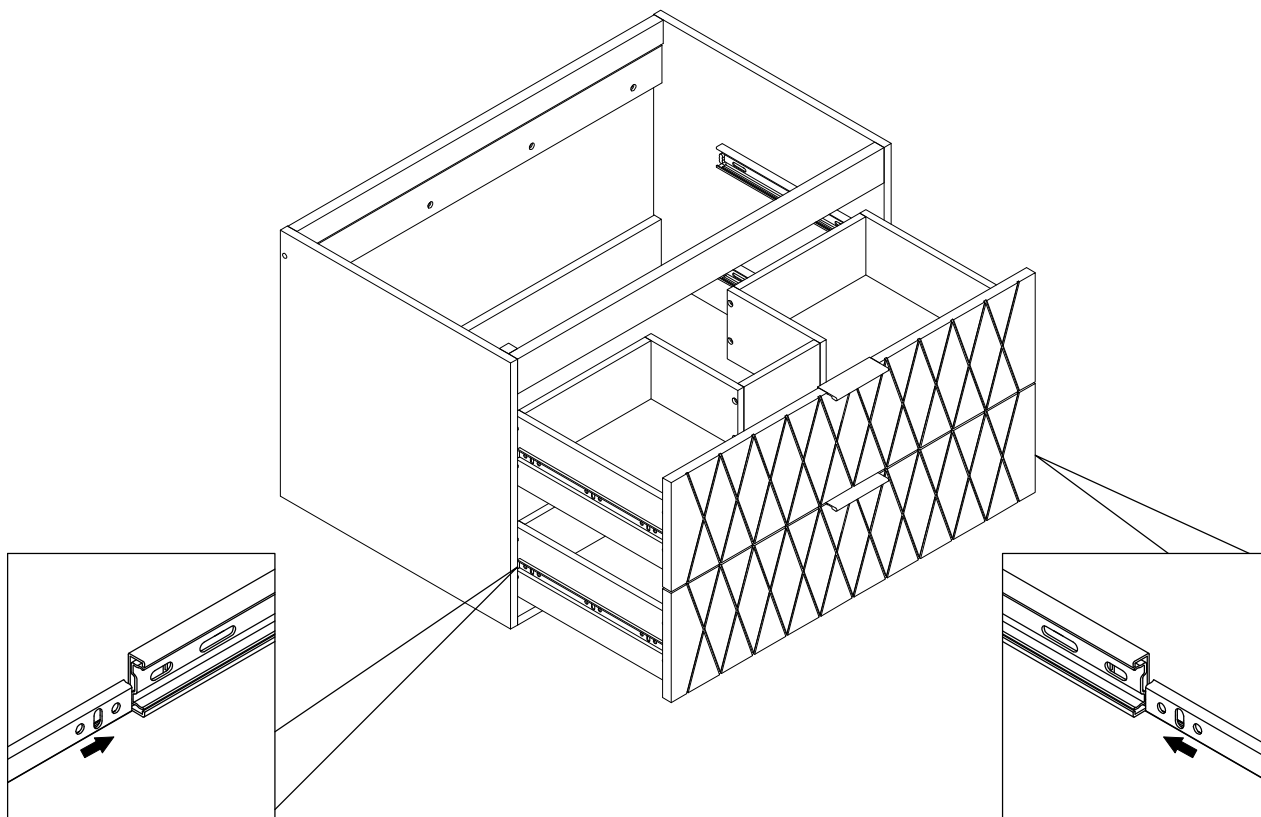

STEP: 11

Install the sink on the cabinet with glue.
Let stand for 24 hours

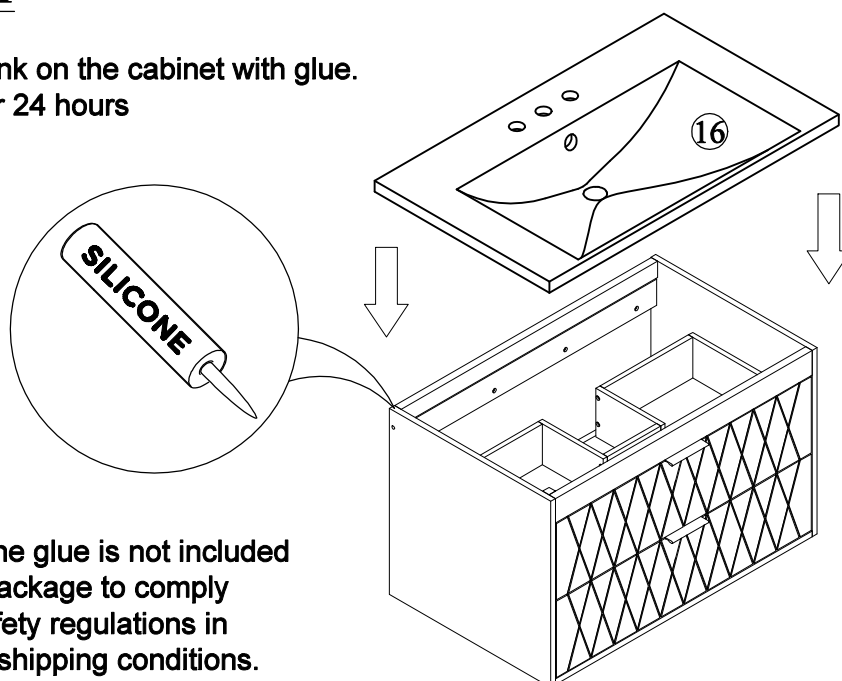

*Silicone glue is not included
in the package to comply
with safety regulations in
certain shipping conditions.

STEP: 12

Wall

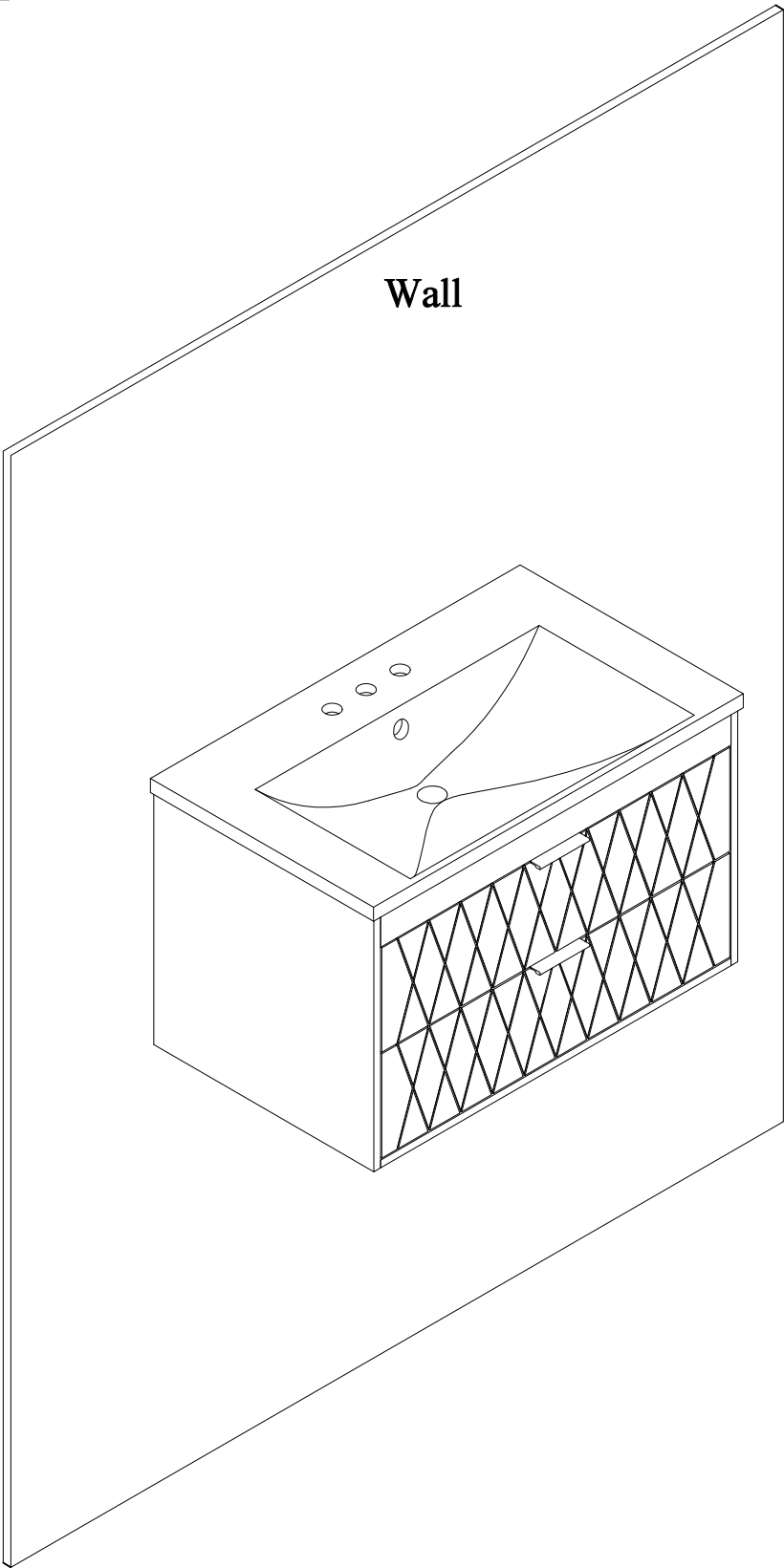

HINGE ADJUSTMENTS

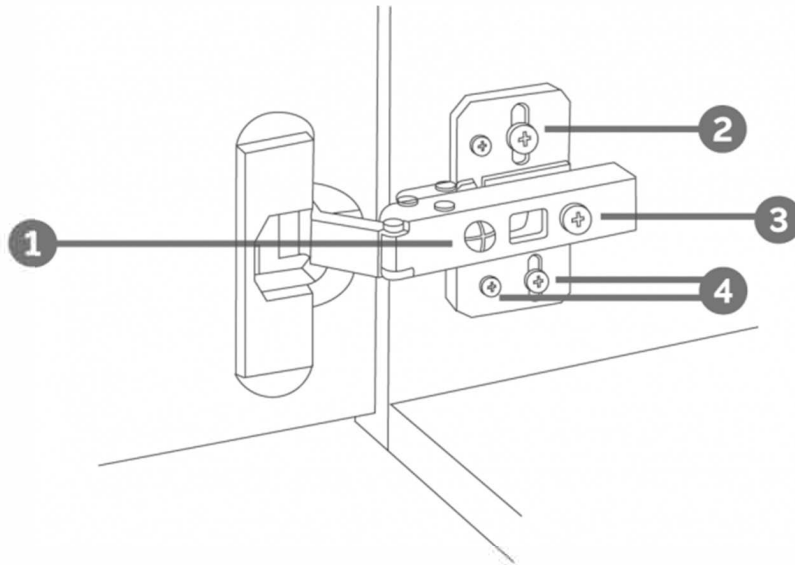

1 Sideways / Tilt adjustment

Turn the screw
clockwise to move the door further away from
the side of the cabinet
anticlockwise to move the door closer to the
side of the cabinet

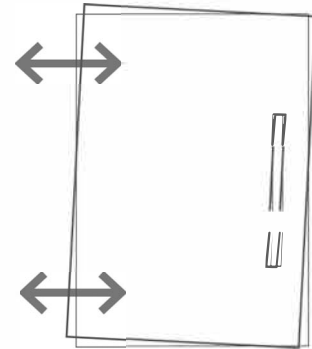

2 4 Height adjustment

While supporting the weight of the door, turn the
screws
clockwise to move the door up
anticlockwise to move the door down

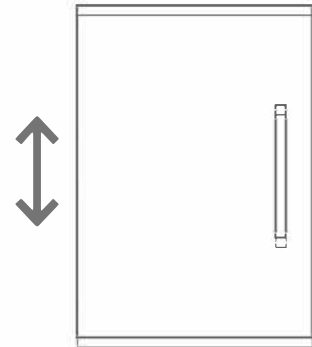

3 Forward and back adjustment

If the gap between the back of the door and the
cabinet is too small, and the door may not close
fully. Turn the screw
clockwise to decrease the gap between the
door and the cabinet
anticlockwise to increase the gap between the
door and the cabinet

