

12FT Climbing Dome

USER AND ASSEMBLY MANUAL

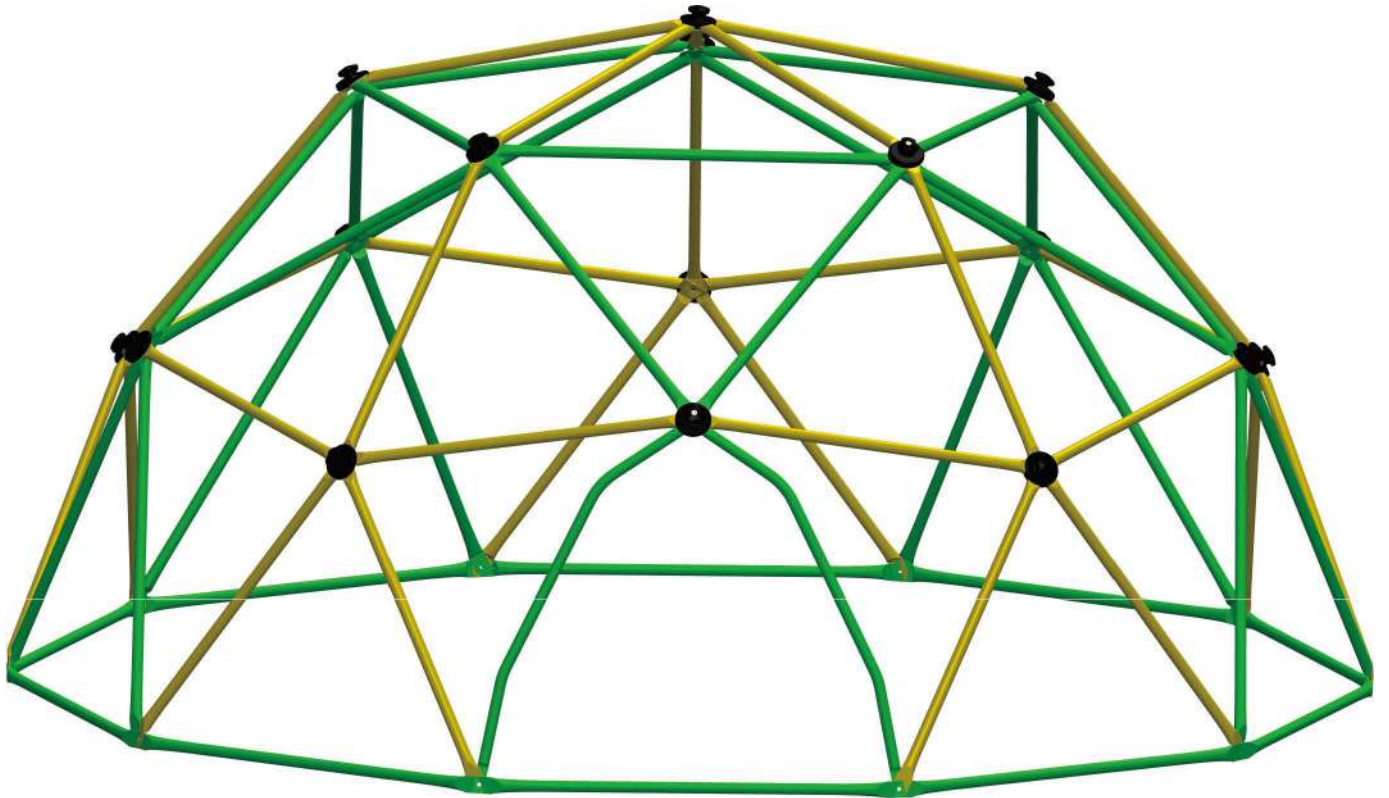

WARNINGS!

TOY MUST BE ASSEMBLED BY AN ADULT BEFORE USE.
CHILDREN MUST NOT USE THIS PRODUCT UNTIL PROPERLY INSTALLED.
THIS PRODUCT CONTAINS SMALL PARTS AND IS NOT SUITABLE FOR CHILDREN UNDER 36 MONTHS UNTIL FULLY ASSEMBLED.

REMOVE ALL PACKAGING BEFORE GIVING TO YOUR CHILDREN.
RETAIN PACKAGING FOR FUTURE REFERENCE.
KEEP AWAY FROM FIRE.

PLEASE DO NOT RETURN TO STORE



**Please do not return this product to the retailer!!
We are able to assist you in ANY way**

If you find that you have any trouble with assembly or missing or damaged parts please contact the seller.

BEFORE ASSEMBLY

Check the entire box and all packing material for parts and/or additional instruction material.

Read the instructions and identify all parts and hardware using the parts list.

Test fit all bolts by inserting them into their respective holes.

Do not scrape away all of the powder coating. Bare metal may rust.

SAFETY INSTRUCTIONS

FAILURE TO FOLLOW THESE WARNINGS MAY RESULT IN SERIOUS INJURY OR PROPERTY DAMAGE AND WILL VOID WARRANTY. Owner must ensure that all players know and follow these rules for safe operation of the system.

To ensure safety, do not attempt to assemble this product without following the instructions carefully.

- If using a ladder during assembly, use extreme caution.
- Two capable adults are recommended for this operation.
- Be aware that parts can be damaged by over tightening the screws.

All who participate in the assembly process should wear safety glasses throughout the assembly

Most injuries are caused by misuse and/or not following instructions. Use caution when using this product.

1. Do not install over concrete, asphalt, packed earth, or any other hard surface, and is for outdoor residential use only. A fall onto a hard surface can result in serious injury.
2. This product is not for Commercial use.
3. Adult assembly required.
4. Adult supervision required at all times. All players need to be supervised, regardless of skill level or age.
5. It is advised that on a regular basis (i.e. at the beginning of the season and monthly thereafter) all main parts/fixings are checked as secure, have no sharp points/edges and are intact. Replace and/or tighten when necessary. Failure to do so may result in an injury or hazard.
6. Any attachments such as swings, chains, ropes, etc must be regularly examined for evidence of deterioration.
7. Do not over-tighten nuts and screws as this may cause them to shear and potentially cause structural failure.
8. **USE AT YOUR OWN RISK! USING A DRILL IS NOT RECOMMENDED FOR DRIVING BOLTS.** A cordless drill can be used for driving screws; however, care should be taken not to over-tighten or strip screws.
9. Save this instruction for future use.

****IMPORTANT SAFETY INFORMATION****

PLEASE READ BEFORE ASSEMBLY:

INSTALLATION & GROUND PREPARATION INSTRUCTIONS:

- Place the equipment on a level, well-drained ground, not less than 6.6 ft (2.0 m) from any structure or obstruction such as a fence, garage, house, overhanging branches, laundry lines, or electrical wires.
- Provide enough room so that children can use the equipment safely. For example, for structures with multiple play activities, a slide should not be placed in front of a swing.
- Separate active and quiet activities from each other. For example, locate sandboxes away from swings or use a guardrail or barrier to separate the sandbox from the movement of the swings.
- Do not install home playground equipment over concrete, asphalt, packed earth, grass, carpet, or any other hard surface. A fall onto a hard surface can result in serious injury to the equipment user.
- To prevent serious injury, warn children that they must not use the equipment until properly installed.
- Create a site free of obstacles that could cause injuries – such as low overhanging tree branches, overhead wires, tree stumps and/or roots, large rocks, bricks, and concrete.
- Choose a level location for the equipment. This can reduce the likelihood of the play set tipping over and loose-fill surfacing materials washing away during heavy rains.

PLAYGROUND AND SURFACE MATERIALS INSTRUCTIONS

Select Protective Surfacing

One of the most important things you can do to reduce the likelihood of serious head injuries is to install shock-absorbing protective surfacing under and around your play equipment. The protective surfacing should be applied to a depth that is suitable for the equipment height in accordance with ASTM Specification F1292. There are different types of surfacing to choose from; whichever product you select, follow these guidelines:

Loose Fill Materials

- Maintain a minimum depth of 9 inches (23 cm) of loose fill materials such as wood mulch/chips, engineered wood fiber (EWF), or shredded/recycled rubber mulch for equipment up to 8 feet (244 cm) high; and 9 inches (23 cm) of sand or pea gravel for equipment up to 5 feet (152 cm) high.

NOTE: An initial fill level of 12 inches (30 cm) will compress to about a 9-inch (23 cm) depth of surfacing over time. The surfacing will also compact, displace, and settle, and should be periodically refilled to maintain at least a 9-inch (23 cm) depth. Use a minimum of 6 inches (15 cm) of protective surfacing for play equipment less than 4 feet (122 cm) in height. If maintained properly, this should be adequate. (At depths less than 6 inches (15 cm), the protective material is too easily displaced or compacted.)

- Do not install home playground equipment over concrete, asphalt, or any other hard surface. A fall onto a hard surface can result in serious injury to the equipment user. Grass and dirt are not considered protective surfacing because wear and environmental factors can reduce their shock-absorbing effectiveness. Carpeting and thin mats are generally not adequate protective surfacing. Ground level equipment – such as a sandbox, activity wall, playhouse or other equipment that has no elevated play surface – does not need any protective surfacing.
- Use containment, such as digging out around the perimeter and/or lining the perimeter with landscape edging. Don't forget to account for water drainage.
- Check and maintain the depth of the loose fill surfacing material. To maintain the right amount of loose fill materials, mark the correct level on play equipment support posts. That way you can easily see when to replenish and/or redistribute the surfacing.
- Do not install loose fill surfacing over hard surfaces such as concrete or asphalt.

Poured-In-Place surfaces or Pre-Manufactured Rubber Tiles

- You may be interested in using surfacing other than loose fill materials – like rubber tiles or poured-in-place surfaces. Installation of these surfaces generally requires a professional and are not a "do-it yourself" project.
- Review surface specifications before purchasing this type of surfacing. Ask the installer/manufacture for a report showing that the product has been tested to the following safety standard: ASTM F1292 Standard Specification for Impact Attenuation of Surfacing Materials within the Use one of Playground Equipment. This report should show the specific height for which the surface is intended to protect against serious head injury. This height should be equal to or greater than the fall height – vertical distance between a designated play surface (elevated surface for standing, sitting, or climbing) and the protective surfacing below – of your play equipment.
- Check the protective surfacing frequently for wear.

Placements

- Proper placement and maintenance of protective surfacing is essential. Be sure to: extend surfacing at least 6.6 feet (2 m) from the equipment in all directions.
- For to-fro swings, extend protective surfacing in front of and behind the swing to a distance equal to twice the height of the top bar from which the swing is suspended. For tire swings, extend surfacing in a circle whose radius is equal to the height of the suspending chain or rope, plus 6.6 feet (2 m) in all directions.

OPERATING INSTRUCTIONS

Observing the following instructions and warnings reduces the likelihood of serious or fatal injury:

- On-site adult supervision should be provided for children of all ages.
- Instruct children not to use the equipment in a manner other than intended.
- To prevent entanglement and strangulation, dress children appropriately, using well-fitting shoes and avoiding ponchos, scarves, jackets with neck drawstrings, helmets with straps, and other loose-fitting clothing that is potentially hazardous while using equipment.
- Instruct children not to play when the equipment is wet.
- Instruct children not to attach items to the playground equipment that are not specifically designed for use with the equipment, such as, but not limited to, jump ropes, clothesline, pet leashes, cables and chains, as they may cause a strangulation hazard. Do not move the equipment while in use.
- Place the equipment no less than 6.6 ft. (2.0 m) from any structure or obstruction such as a fence, garage, house, overhanging branches, laundry lines, or electrical wires.
- Impact surfacing needs to cover the entire recommended play area.





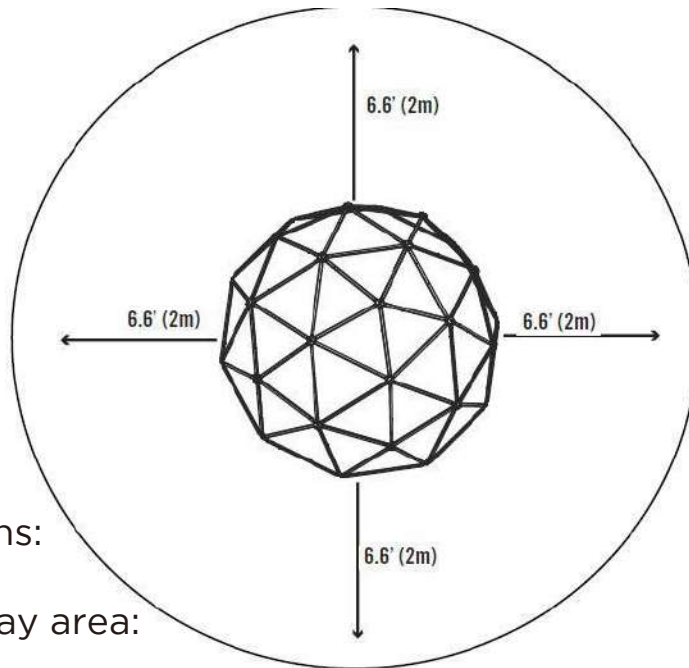









SAFE PLAY AREA

SAFETY ZONE - Place the equipment no less than 6.6 ft from any structure or obstruction such as a fence, garage, house, overhanging branches, laundry lines, or electrical wires. The impact surfacing needs to cover the entire recommended play area. Refer to the example below.



Play set dimensions:
12' x 12'
Recommended play area:
18' 6" x 18' 6"

Part List

<p>A</p>  <p>Green Long Tube (x 28 pcs)</p>	<p>B</p>  <p>Yellow Short Tube (x 30 pcs)</p>	<p>C</p>  <p>Climbing Grip (x 16 pcs)</p>	<p>D</p>  <p>M8 x 25mm Nut (x 16 pcs)</p>	<p>E</p>  <p>M8 x 40mm Bolt (x 16 pcs)</p>
<p>F</p>  <p>φ10 x 25mm Bolt (x 10 pcs)</p>	<p>G</p>  <p>M8 Nylon Nut (x 10 pcs)</p>	<p>H</p>  <p>M8 Washer (x 36 pcs)</p>	<p>I</p>  <p>Allen Key (x 2 pcs)</p>	<p>J</p>  <p>Wrench (x 1 pc)</p>
<p>K</p>  <p>M8 LockNut (x 16 pcs)</p>	<p>L</p>  <p>Gloves (x 2 pairs)</p>	<p>M</p>  <p>Tube with silver mark (x 5 pcs)</p>	<p>N</p>  <p>Left Gate Tube (x 1 pc)</p>	<p>O</p>  <p>Right Gate Tube (x 1 pc)</p>

ASSEMBLY

Step 1

Lay out 10 Green Tubes (#A) and form a decagon as illustrated below.

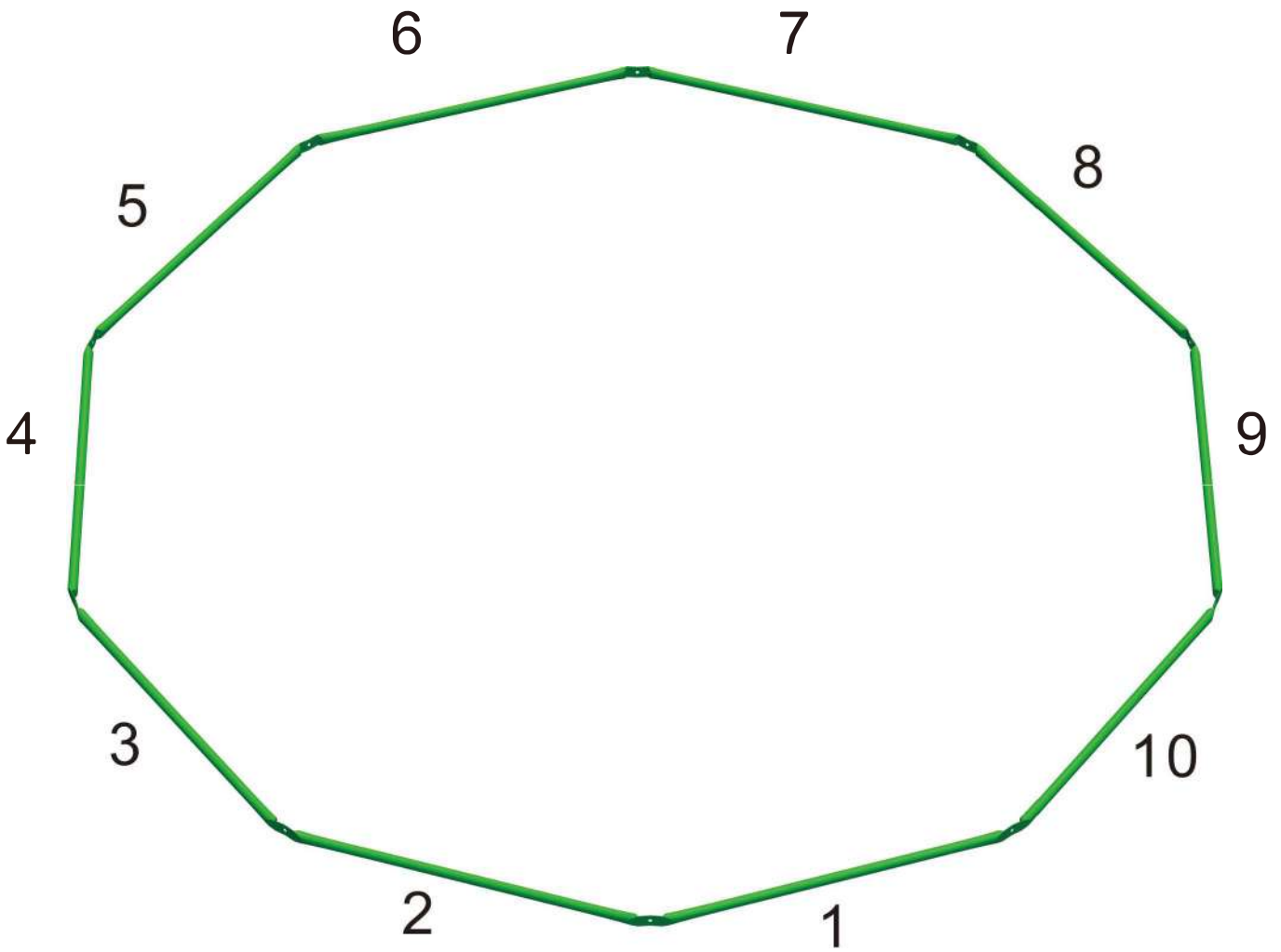

Step 2

Slide an M8 Washer(#H) over $\phi 10 \times 25\text{mm}$ Bolt(#F), then slide the Bolt(#F) through the joint of 2pcs Green Tubes(#A) on the ground, 1pc Yellow Tube(#B) and 1pc Green Left Gate Tube(#N) in the order indicated by the numbers. Slide another M8 Washer(#H) over the Bolt(#F) and secure with an M8 Nylon Nut(#G).

Hold the nut with a wrench while tightening the Bolt.

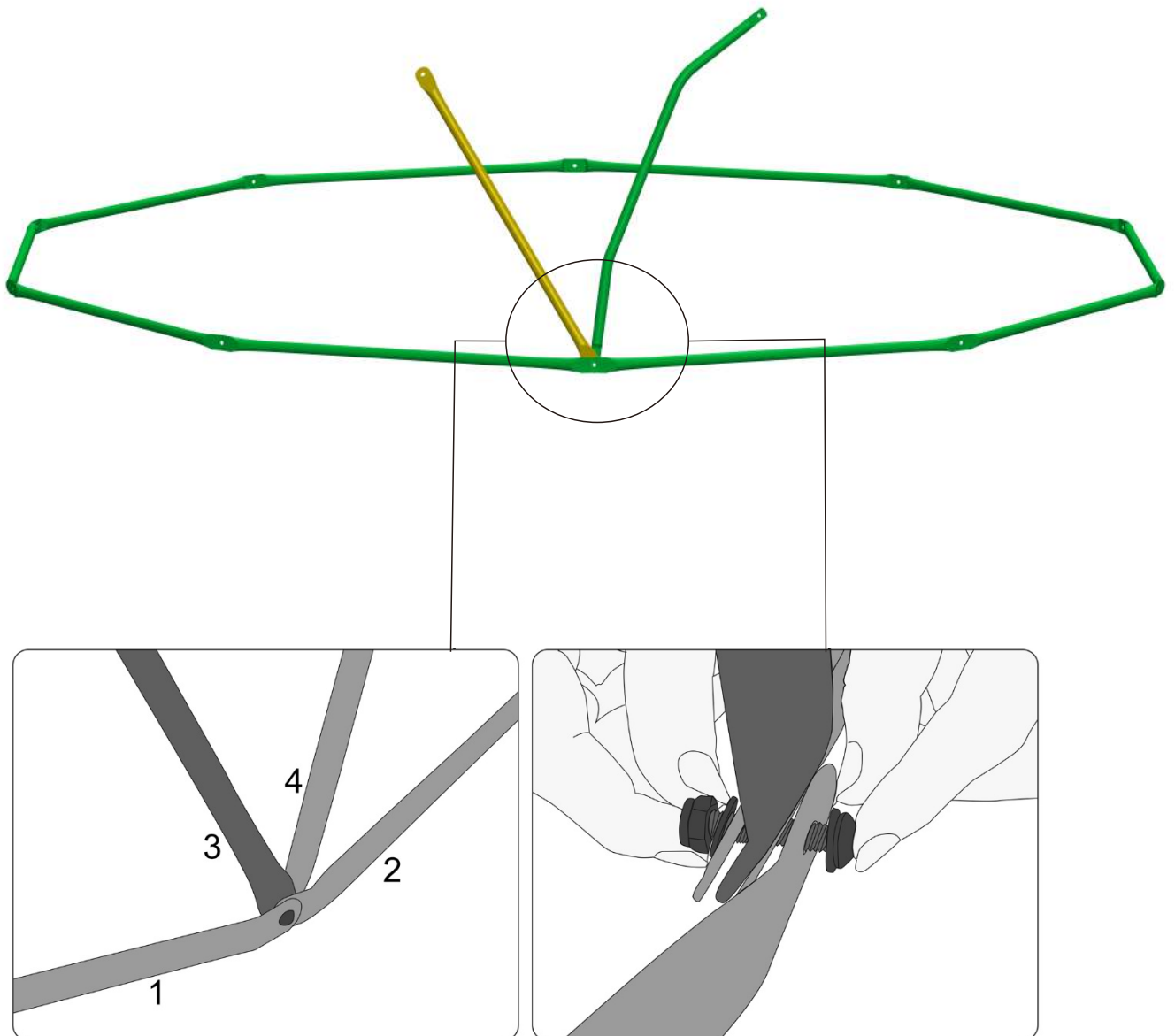

Step 3

Attach a Yellow Tube(#B) and the Green Right Gate Tube(#O) to the bottom joint in the right, slide a $\phi 10 \times 25\text{mm}$ Bolt(#F) through an M8 Washer(#H), the four tubes (in the same order indicated above), another M8 Washer(#H) and an M8 Nylon Nut(#G).

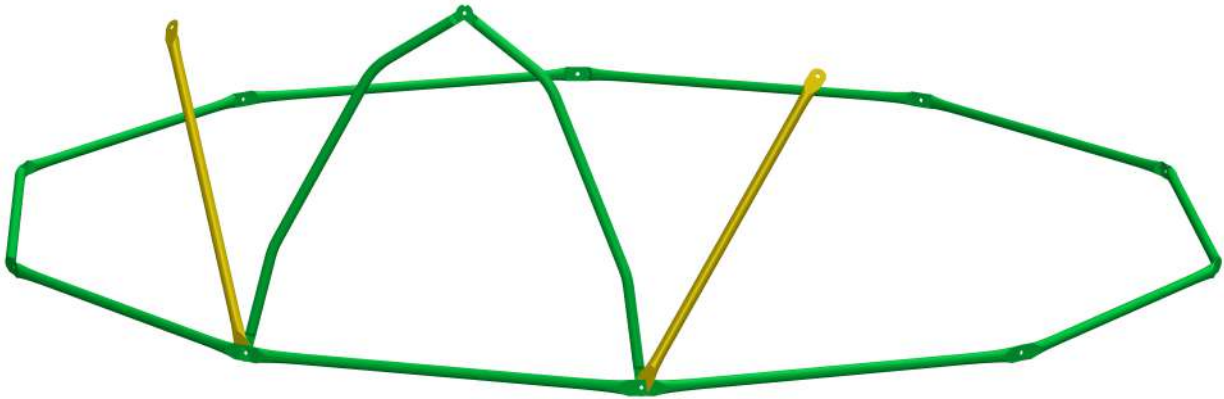

Repeat the same step to attach a Yellow Tube(#B) and a Green Tube(#A) to the next joint, and secure with 1pc $\phi 10 \times 25\text{mm}$ Bolt(#F), 2 pcs M8 Washer(#H) and 1pc M8 Nylon Nut(#G).

Repeat until you have assembled all 10 joints in the bottom. Now, the bottom circle is finished.

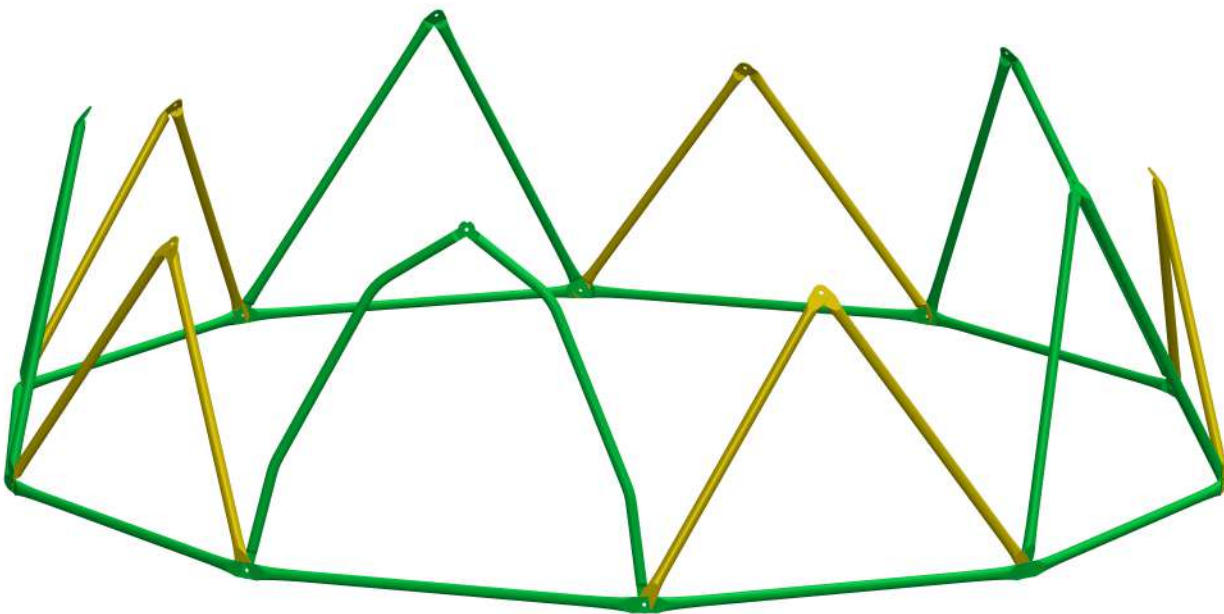

Note: Each joint at the bottom circle is connected by 4 tubes.

Now let's start the second circle!

Step 4

Attach 3 Yellow Tubes(#B) to the yellow joint in bottom circle, secure with 1pc M8 x 40mm Bolt(#E), 1pc M8 Washer (#H) and 1pc M8 Nut (#K).

Make sure the five yellow tubes are placed in an anti-clockwise direction, in the order indicated by the numbers.

Note:

The bolt goes through from inside out, with the head of the bolt on the inside.

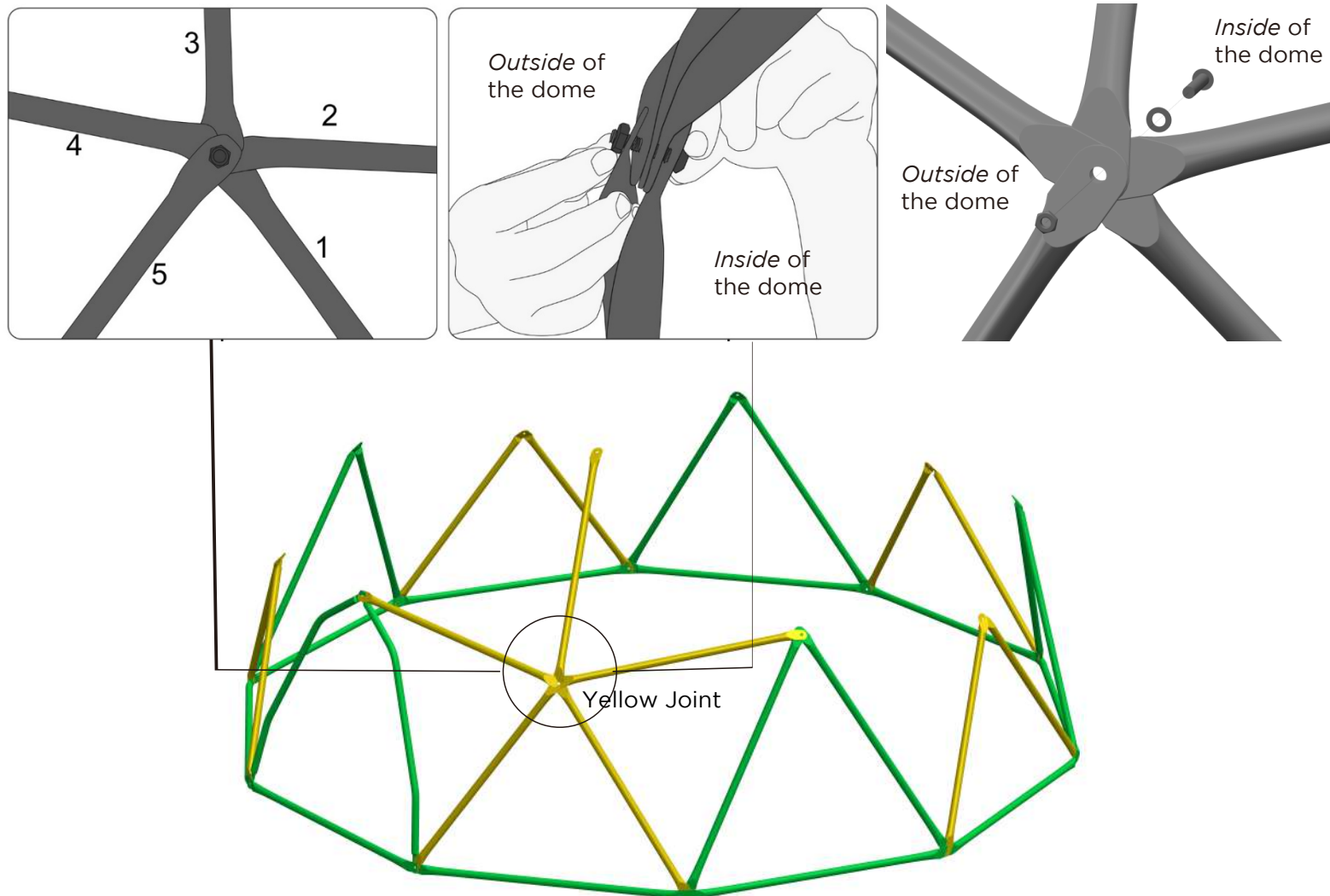

Step 5

Then, next to the joint we just assembled, add 2pcs Green Tubes(#A), 1 Yellow Tube(#B) in the order indicated by the numbers.

Secure the joint with 1pc M8 x 40mm Bolt(#E), 1pc M8 Washer(H) and 1pc M8 Nut(#K).

Note:

The bolt goes through from inside out, with the head of the bolt on the inside.

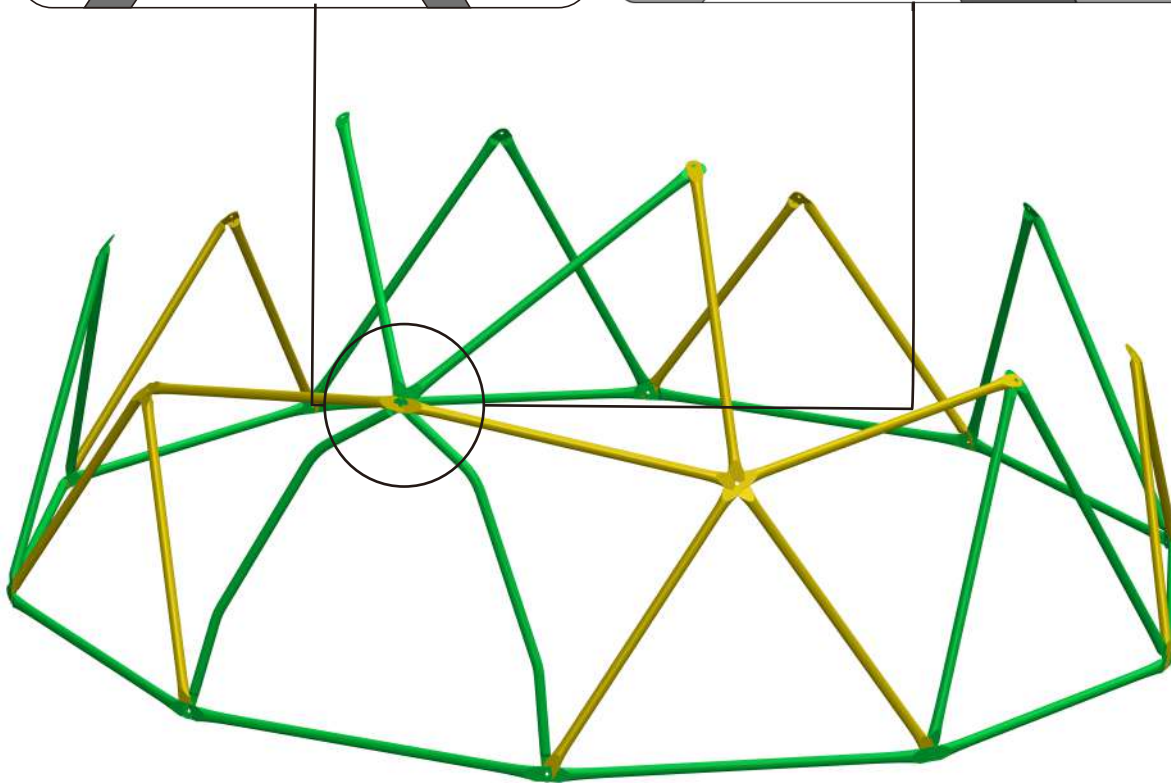
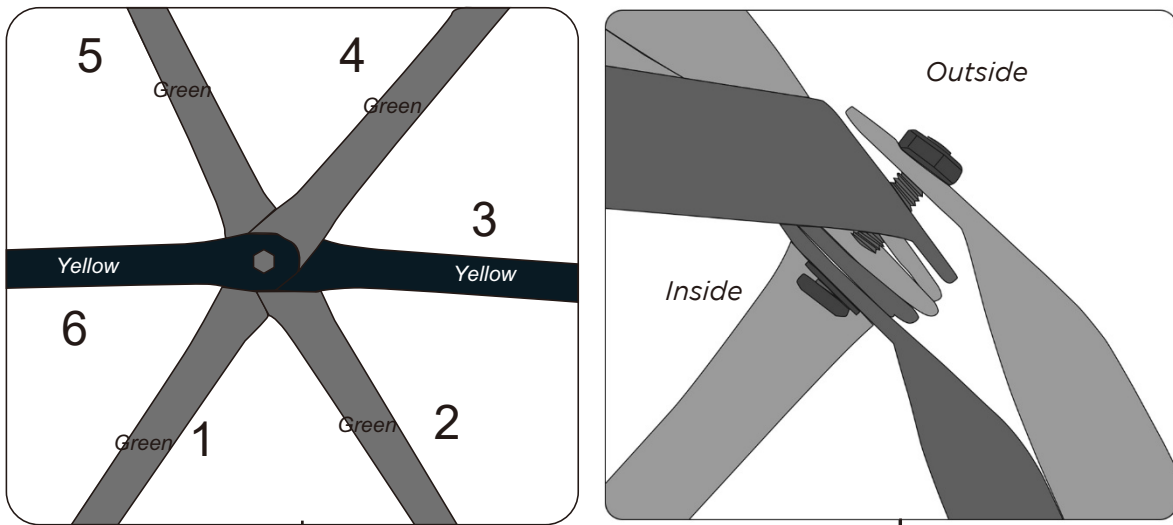

Step 6

Repeat the previous steps and assemble the second circle as illustrated below.

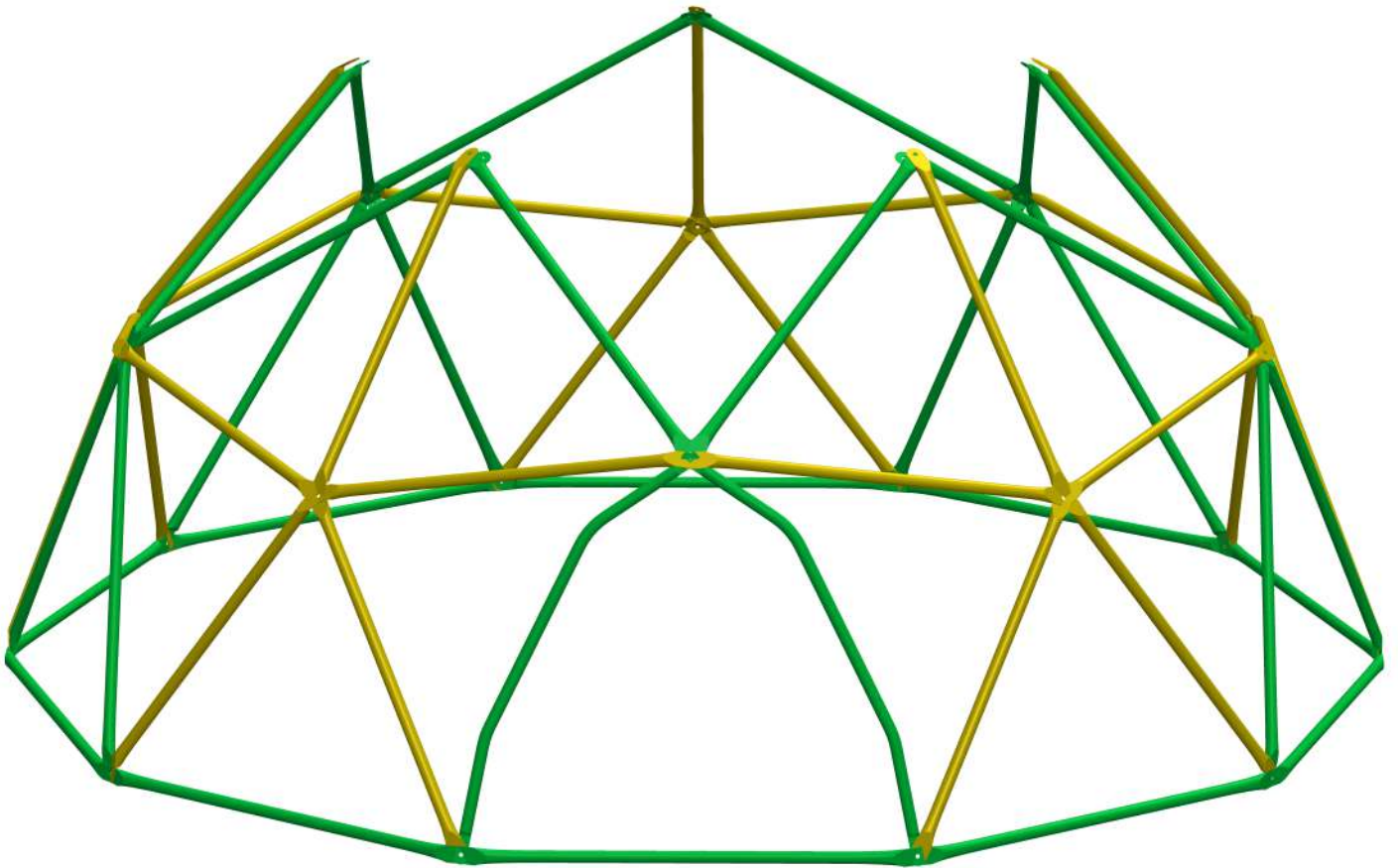

Step 7

Now let's start assembling the third circle.

Add 2pcs Green Tubes with Silver Mark(#M), 1 Yellow Tube(#B) to the joint as shown in picture, and make sure all 6 tubes are placed in the order indicated by the numbers.

Secure the joint with 1pc M8 x 40mm Bolt(#E), 1pc M8 Washer(H) and 1pc M8 Nut(#K).

Note:

The bolt goes through from inside out, with the head of the bolt on the inside.

In this joint, you have 2pcs Green Tubes (#A), 2pcs Yellow Tube(#B), and 2pcs Green Tubes with Silver Mark(#M) connected together (6pcs tubes in total).

Repeat the same step to complete the rest of the joint assembly.

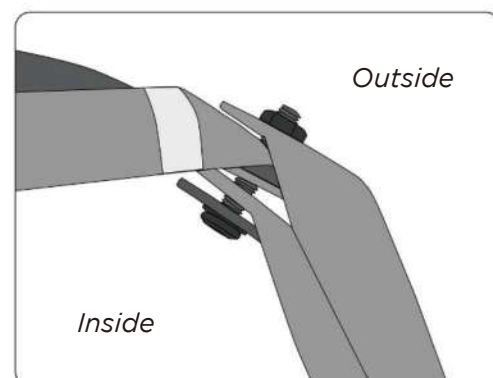
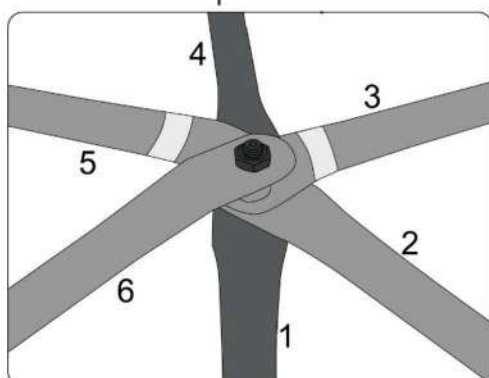
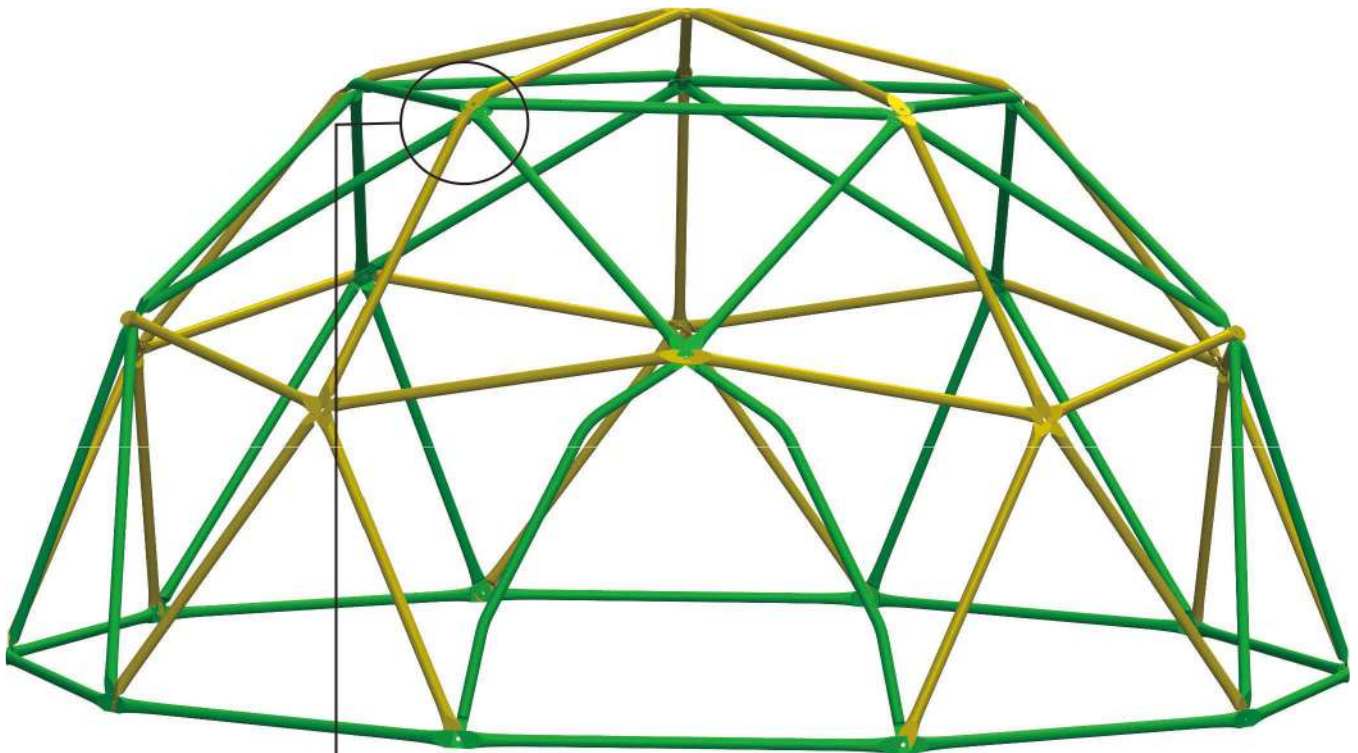

Step 8

Secure the joint on top with 1pc M8 x 40mm Bolt(#E), 1pc M8 Washer(H) and 1pc M8 Nut(#K).

Make sure the 5pcs Yellow Tubes(#B) are placed in the order indicated by the numbers.

Note:

The bolt goes through from inside out, with the head of the bolt on the inside.

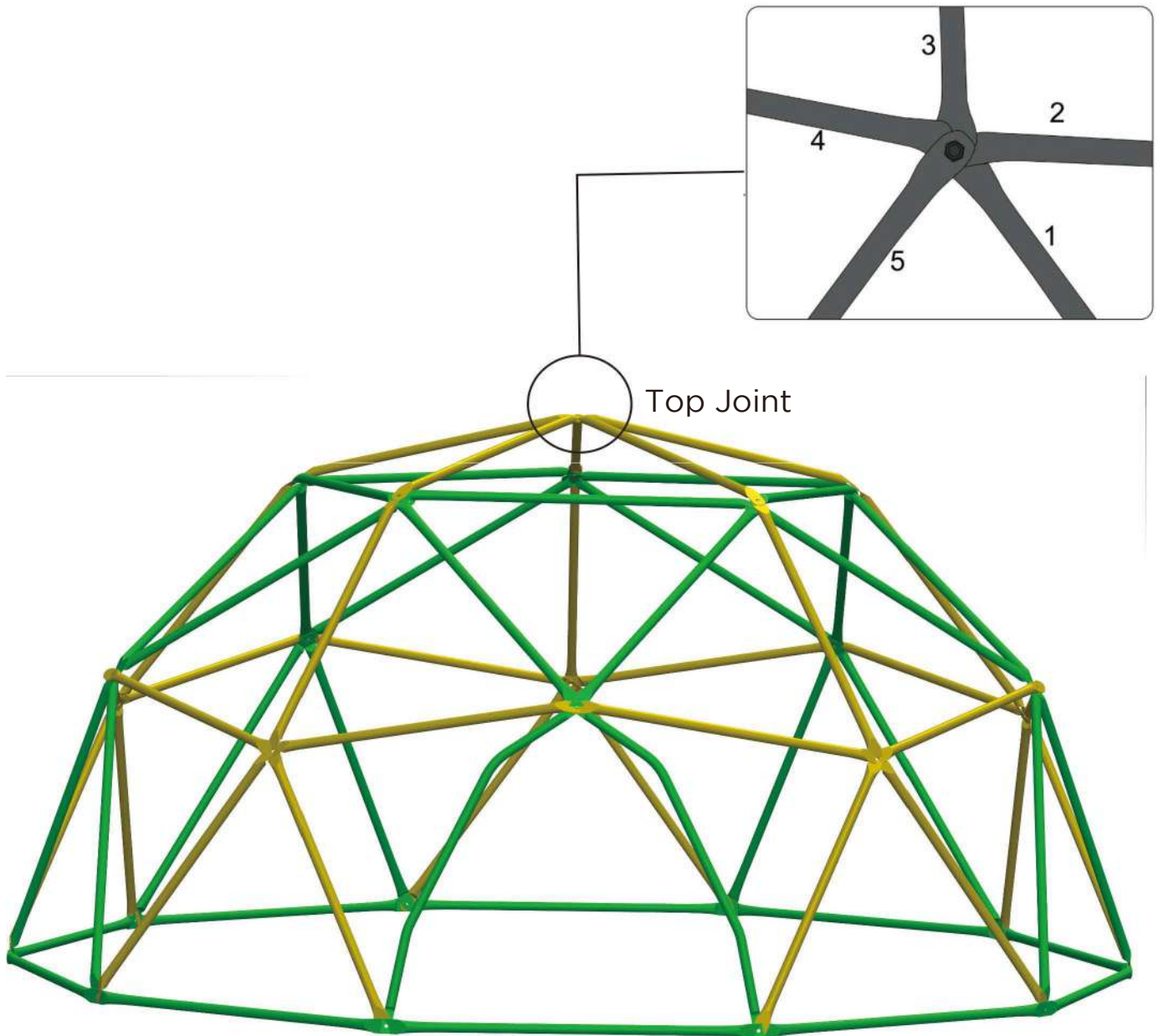

Step 9

Install the Climbing Grips(#C) with M8 x 25mm Nut(#D) to cover the the bolt on each of the joint (except the bottom joints touching the ground).

Please make sure the notch of the grip is between the first and the last tube.

14