

Ice Bucket Table

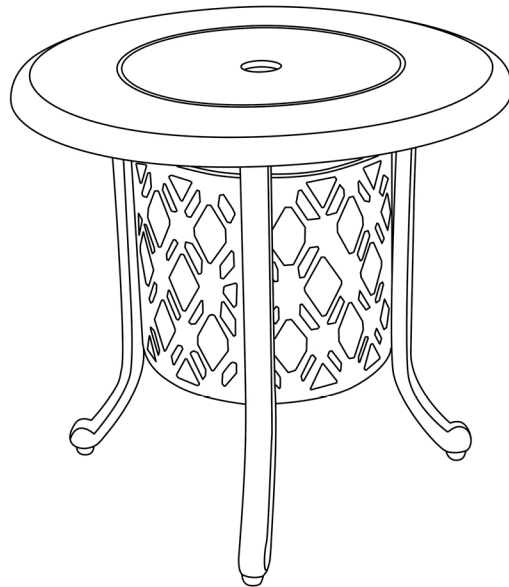





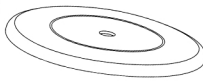
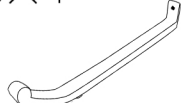

ASSEMBLY INSTRUCTIONS

HS1805

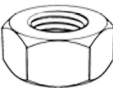

BEFORE ASSEMBLY:

- Please read these instructions carefully before starting assembly. We suggest you carry out the assembly on a soft surface like a carpet, so as to avoid scratching the paint. Keep children away during assembly. This item contains small parts which can be swallowed by children.
- This product was made for the explicit purpose of providing outdoor function and is not to be used as a toy. This product is for residential use only. This product is not intended for commercial use; unintended use will void the warranty.
- This product is not intended for use during inclement or severe weather, that includes but is not limited to rain, hail, sleet, snow, wind, freezing conditions and extreme heat.
- Please note because of the nature of cast metal, you may find roughness on the surface which enhances the beauty of the product and is not a defect.
- Aluminum is soft metal, please do not use power tools, and over tighten may strip threads or break the parts.
- When not in use, store and/or cover the product in a cool dry location. Do not locate the product near any sort of high heat. Do not use the product as a support.
- Children under the age of 10, who are near the product, should be supervised by a competent adult at all times.
- Do not discard any of packaging until you finish the assembly. Keep the assembly instructions for future reference or warranty.

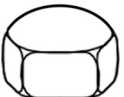
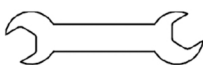
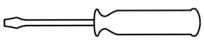
A×1  Table Top	B×4  Leg	C×4  Side Panel	D×4  Headless Screw M8
E×4  Flat Washer M8	F×4  Spring Washer M8	G×4  Nut M8	H×8  Flat Washer M6
I×8  Nut M6	J×4  Adjustable Foot Pad	K×8  Plastic Cap M6	L×4  Plastic Cap M8
M×1  Wrench	N×1  Slotted Screwdriver		

1

Step 1: Place all parts on a smooth and clean surface. Attach four legs (B) to the table top using headless screw M8(D), flat washer M8(E), spring washer M8(F) and nut M8(G). Do not tighten at this stage.

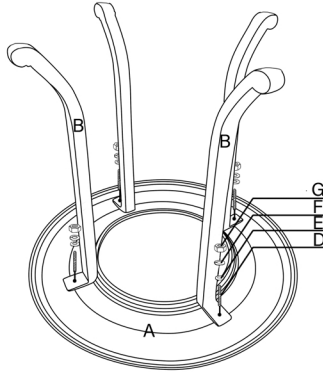

2

Step 2: Attach the side panel to the table legs using flat washer M6(H) and nut M6(I). Attach side panel (CR) to legs (B) first. Then put the side panel (CL) and tighten them. Put on the plastic cap (K).

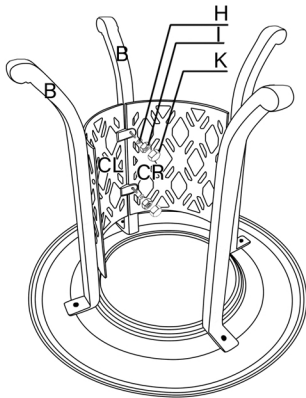

3

Step 3: Tighten every part after adjustment and put on the plastic cap (L). Put the ice bucket into the table center.

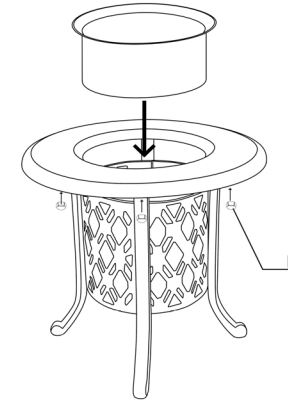

4

Step 4: Fix the adjustable feet pads (J) under legs (B) if the table is unbalanced. Now you can enjoy it.

