



Warnings and Cautions

Please retain this instruction for future usage and read carefully before assembly.

Make sure you have all the parts & hardware as item list shows.

***2 adults or more** are recommended to install your gazebo.*

Do not discard any of the packaging until you have checked that you have all the parts and pack of fittings.

Check all bolts for tightness before use, and periodically check and tighten bolts ensure your gazebo works properly.

Some parts might have sharp edges/corners. Please follow basic safety precautions to reduce the risk of hurts.

*Maximum weight capacity is **2500 pounds**.*

*It is essential to place the gazebo on level ground and not less than **6 feet** from any obstruction such as fences, garages, the house, overhanging branches, laundry lines, or electrical wires.*

If you have questions or concerns.

*Please contact us via email at **service@domioutdoorliving.com***



12'x18'

SKU:LGMF1528B

HARDTOP GAZEBO
WITH DOUBLE ROOF

Assembly Manual

Pre-assembly

TOOLS THAT MAY BE REQUIRED (Not included in boxes)

*NOTE: Tools / equipment are not shown to actual size and scale.



LEVEL

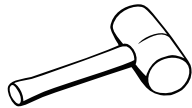

RUBBER Mallet



PHILLIPS SCREW



DRILL

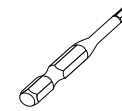

ALLEN KEY

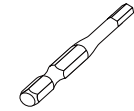

ALLEN KEY

EQUIPMENT REQUIRED (Not included in boxes)

*NOTE: Equipment are not shown to actual size and scale.



SAFETY HAT



GLOVES



SAFETY GOGGLES



STEPLADDER

Matters needing attention



1. Two or more people are required for assembly.



2. Do not fully tighten screws prior to complete assembly.

MOUNTING BLUEPRINT

Gazebo 12×18

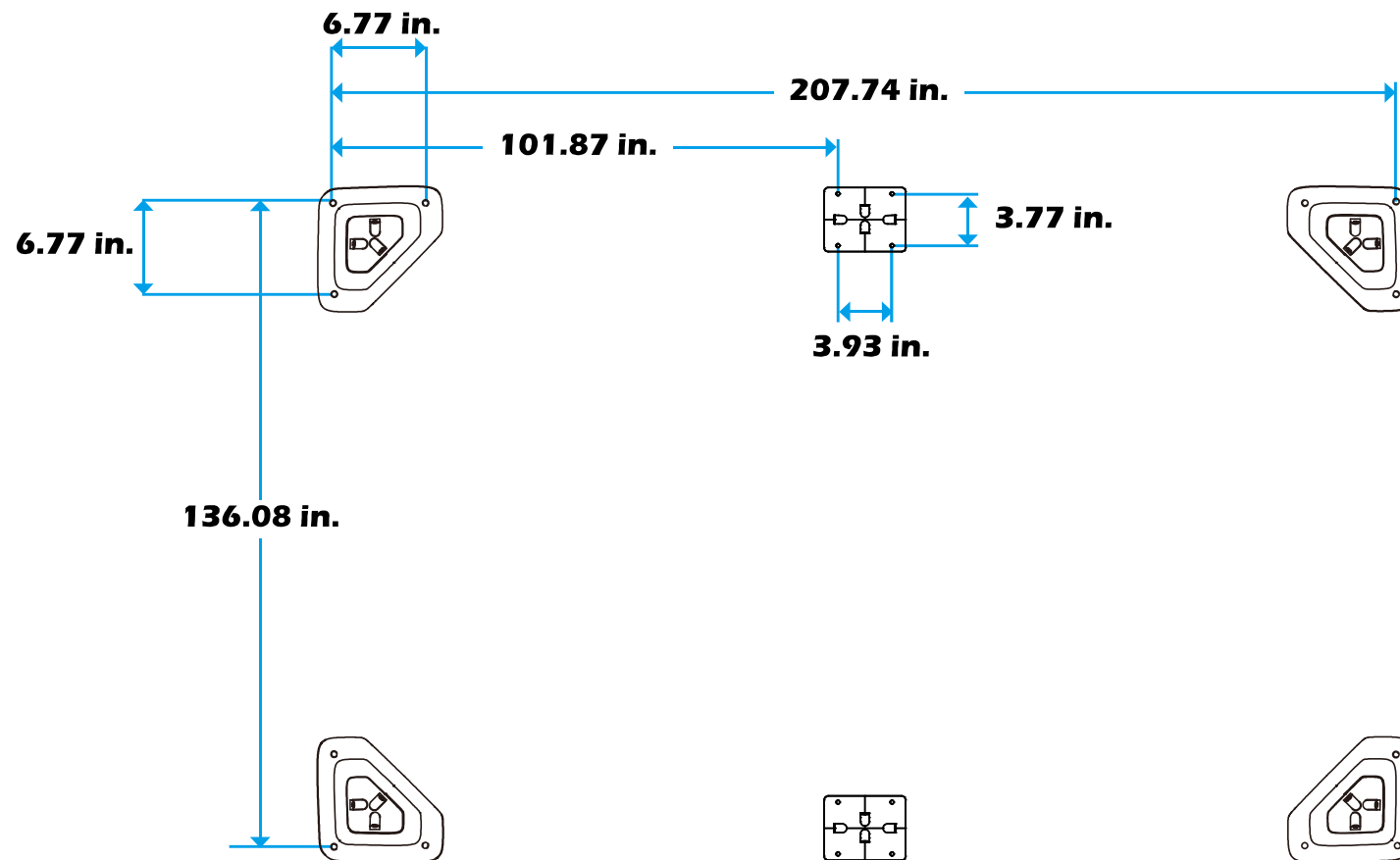

1

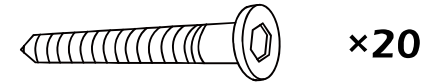
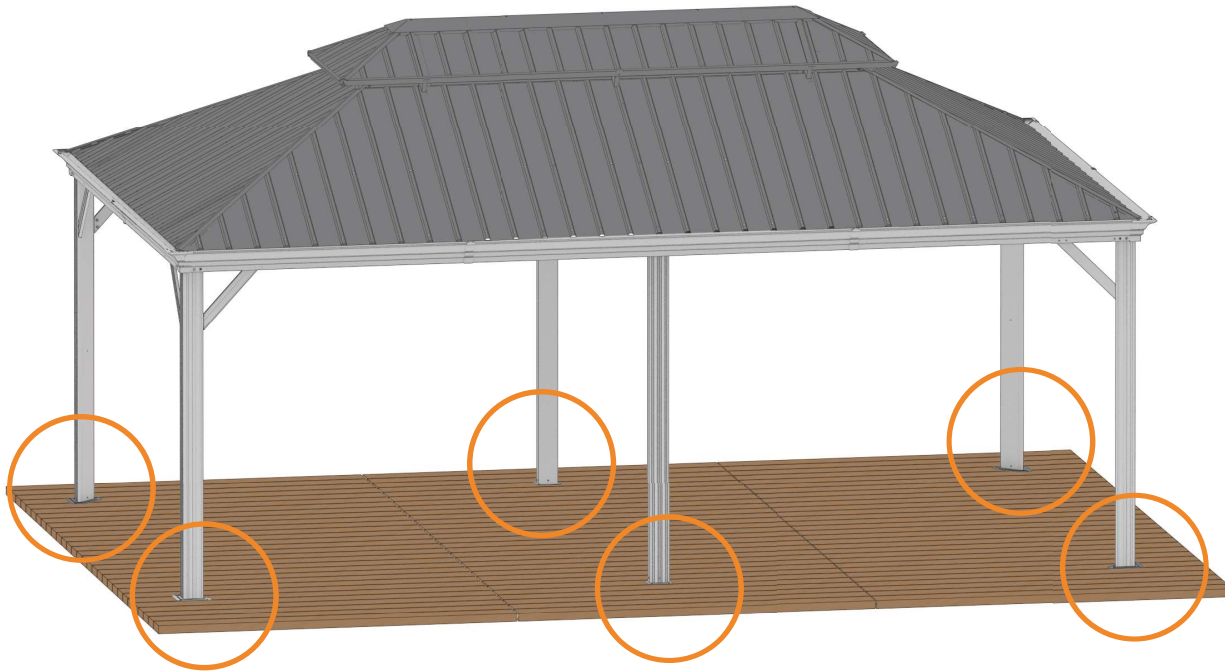

If the deck is hard wood and the depth of it is over 3 inch , you can use **5/16 in. x4 in. Structural Wood Screw** to mount the gazebo.

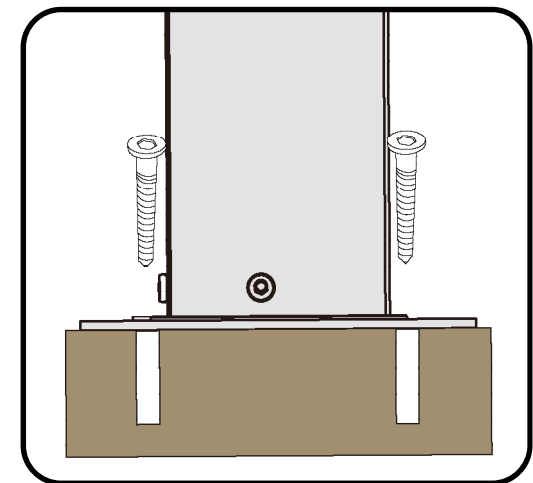
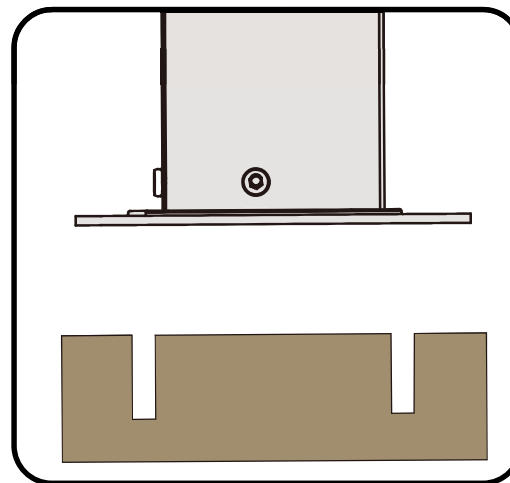

2

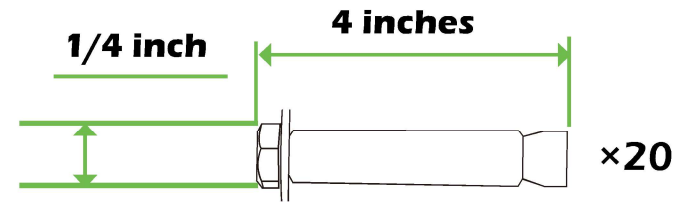
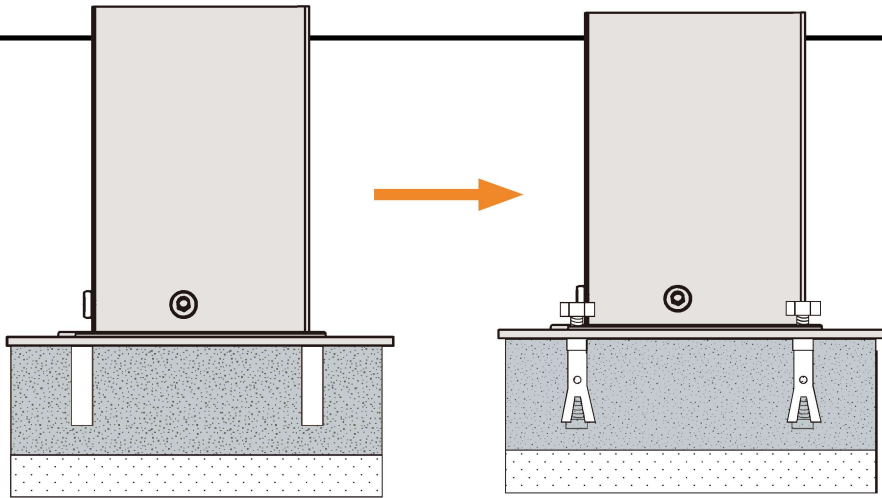

If the ground is concreted and the depth of it is over 3 inch, you can use 1/4 inch expansion bolts to mount the gazebo

3

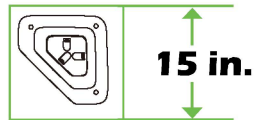
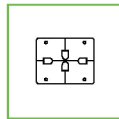
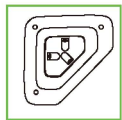

Or you can make a concrete footing for gazebo, **15×15×15 inches** is recommended. use expansion bolts to mount the pergola like ② shows.

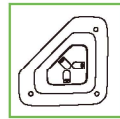
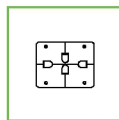

IMPORTANT:
Anchor is not recommended

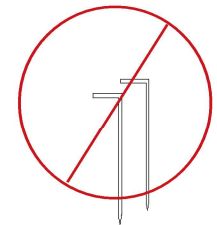

CHECK LIST

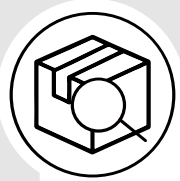

A × 4

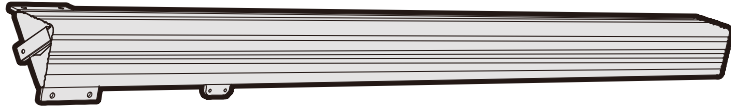

B × 2



C × 4

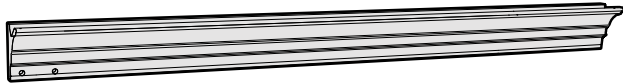

C1 × 4



C2 × 2

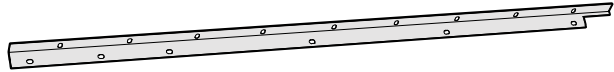

C3 × 2

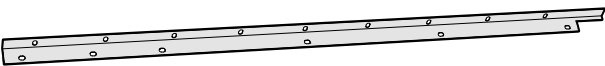

D × 4



D1 × 4



D2 × 2

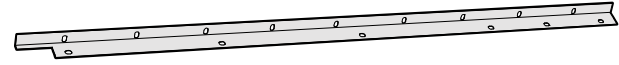

D3 × 2



E × 2

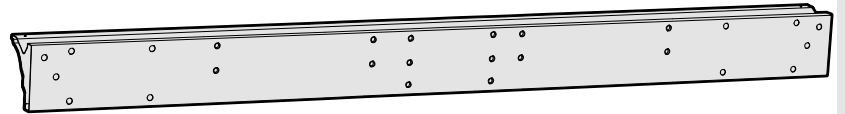

E1a × 2



E1b × 2



E2a × 2



E2b × 2

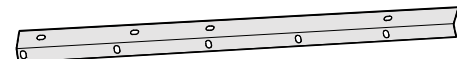

F × 6

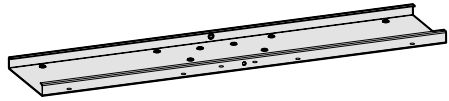

G × 4

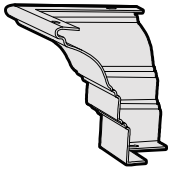

H × 6

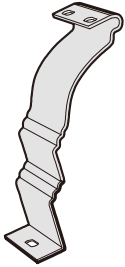

H1 × 6

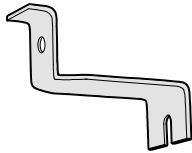

H2 × 1

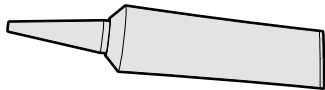

J1 × 4



J2 × 4



K × 1

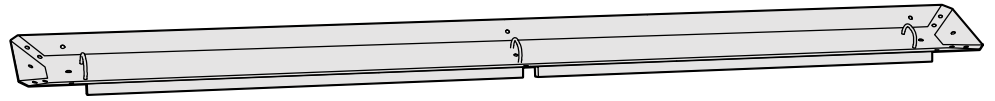

K1 × 1

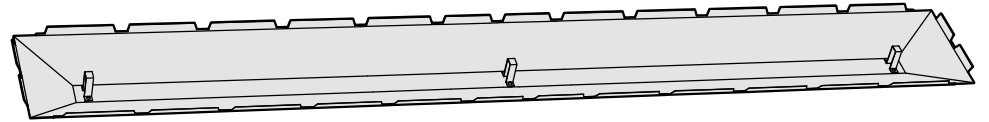

L × 4

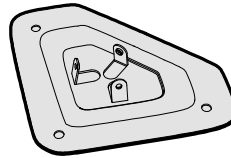

L1 × 2

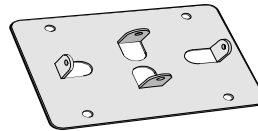

Ma × 4



Mb × 4



N × 2

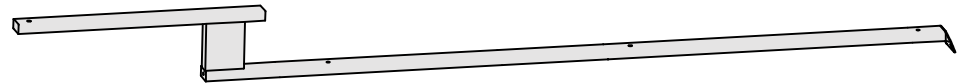

N1 × 4



N2 × 2

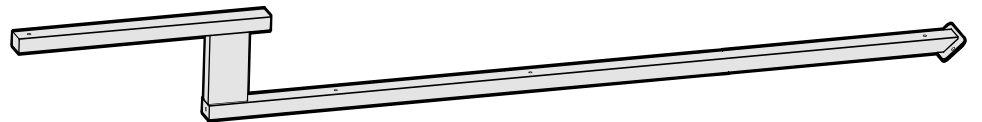

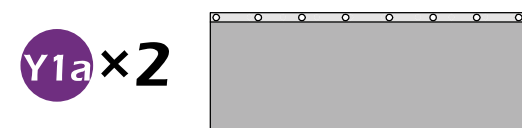
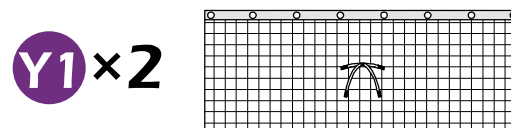
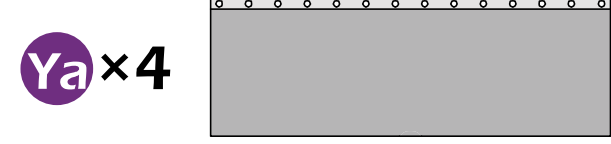
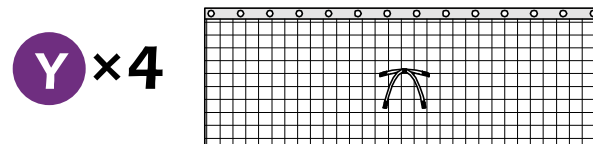
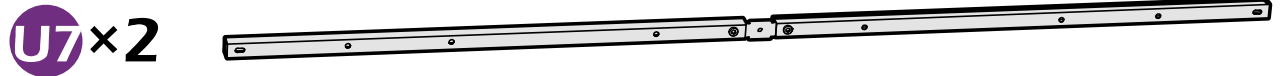
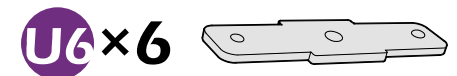
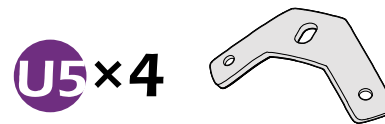
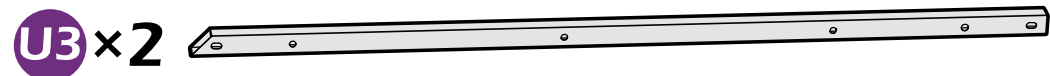
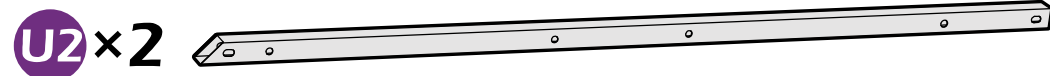
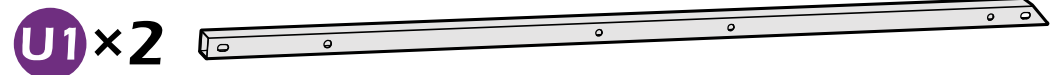
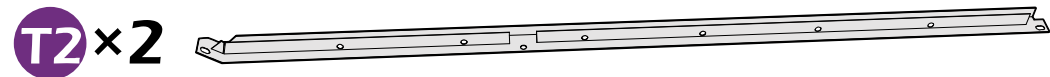
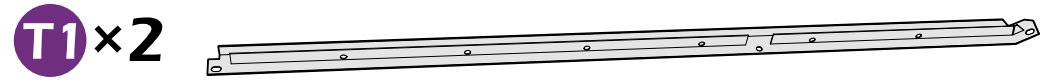
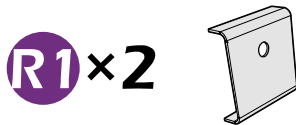
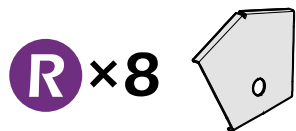
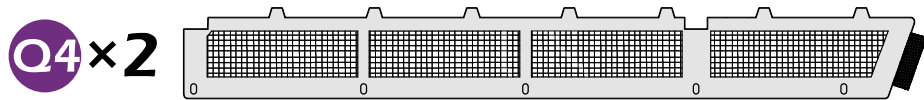
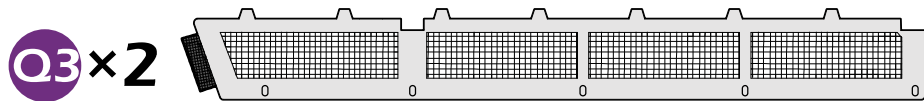
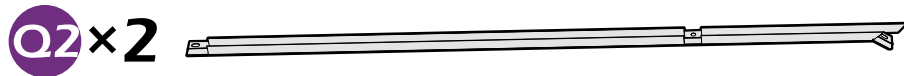
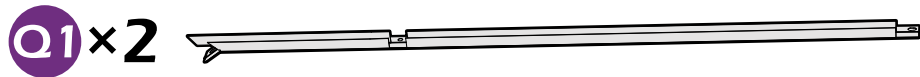
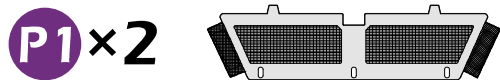
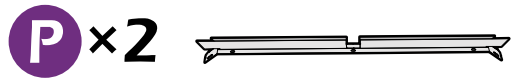

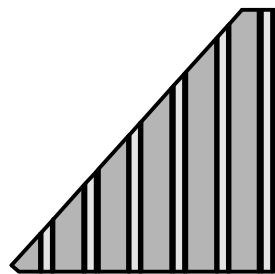

$V1 \times 2$

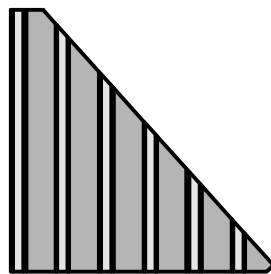

$V2 \times 2$

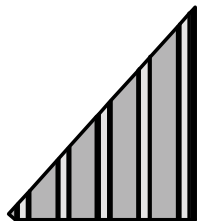

$V3 \times 2$

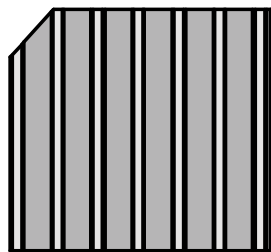

$V4 \times 2$

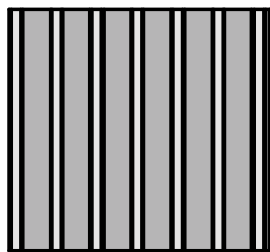

$V \times 4$

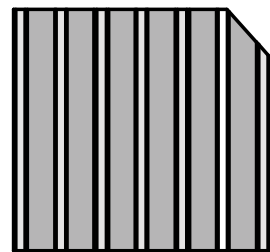

$V5 \times 2$

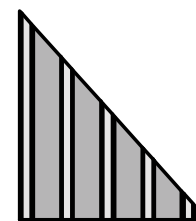

$V6 \times 2$



$W1 \times 2$

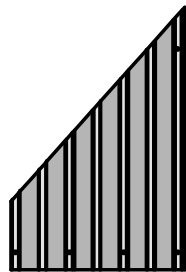

$W2 \times 2$

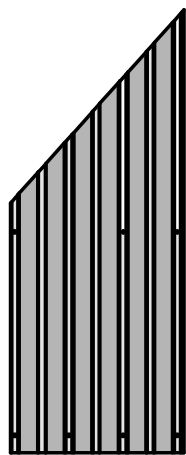

$W3 \times 2$

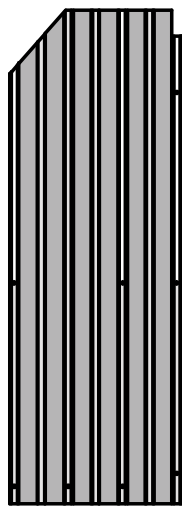

$W4 \times 2$

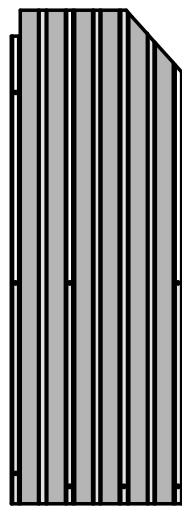

$W5 \times 2$

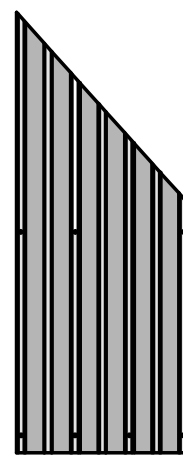

$W6 \times 2$

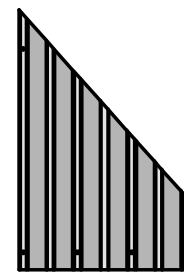

$W7 \times 2$



$W8 \times 2$

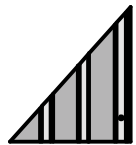

$X_1 \times 2$

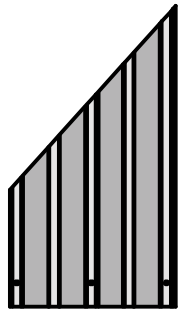

$X_2 \times 2$

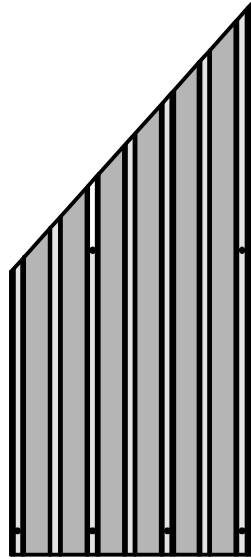

$X_3 \times 2$

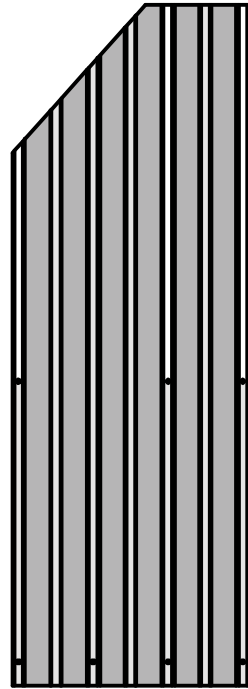

$X_4 \times 2$

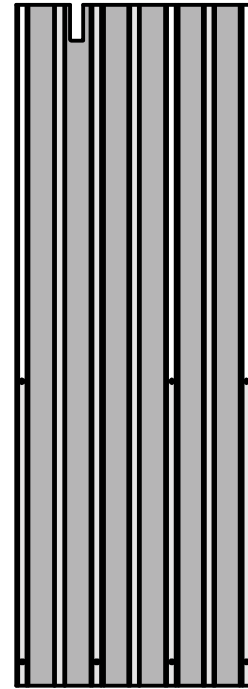

$X_5 \times 2$

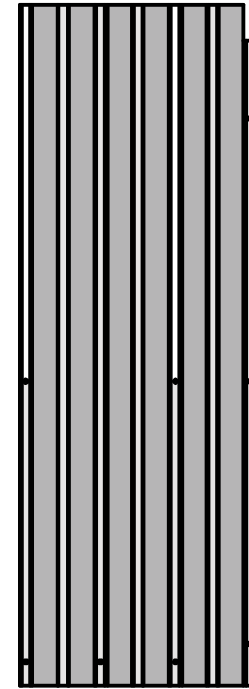

$X_6 \times 2$

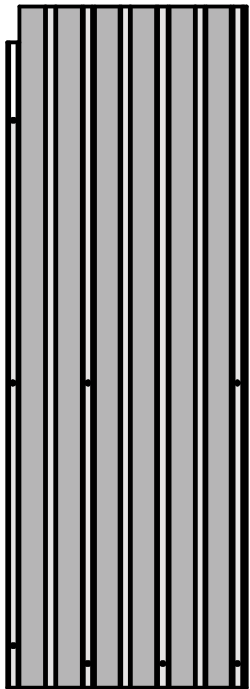

X7×2

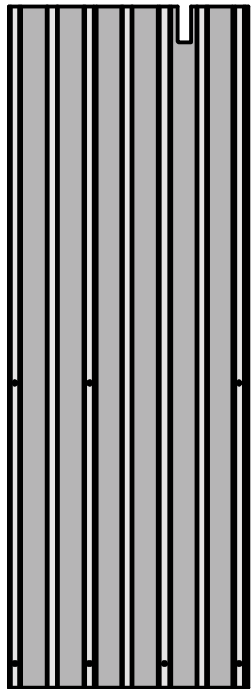

X8×2

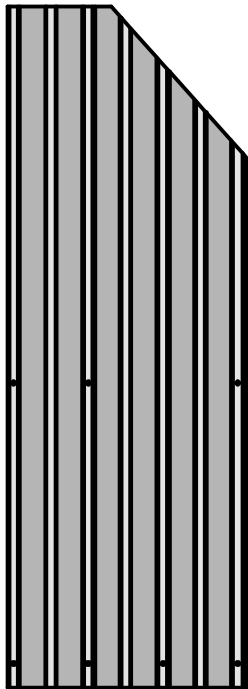

X9×2

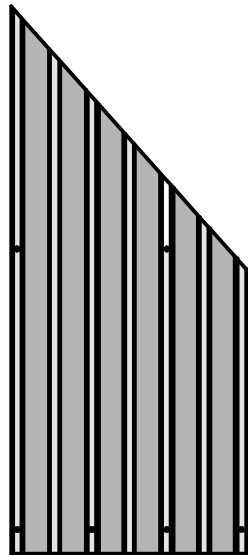

X10×2

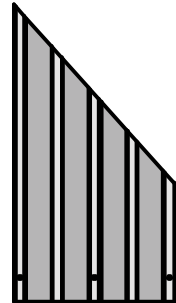

X11×2

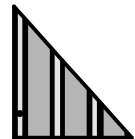

X12×2

Z × 72



4# × 144

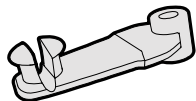

10# × 4
(M6 × 25)

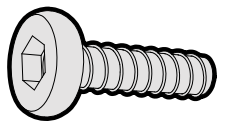

Z1 × 4



5# × 92
(M6 × 28)

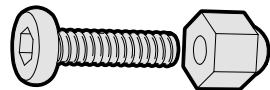

11# × 16
(M6 × 10)

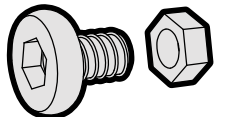

Z2 × 4



6# × 8
(M6 × 45)

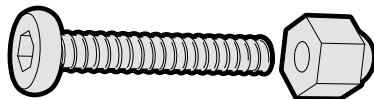

12# × 1

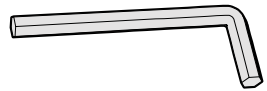

Z3 × 4



Z4 × 4



7# × 44
(M6 × 50)

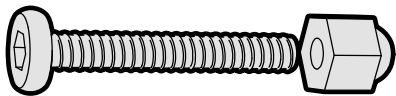

13# × 1



1# × 287
(M6 × 16)

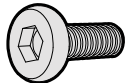

14# × 1

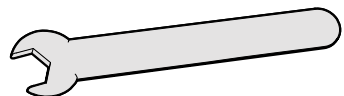

2# × 36
(M6 × 20)

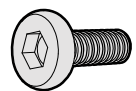

15# × 1

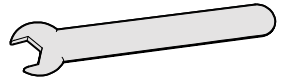

3# × 16

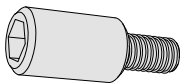

9# × 28
(ST4.8 × 13)

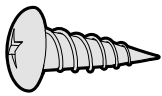

16# × 4
(ST6.3 × 15)

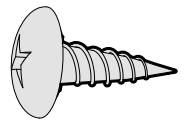

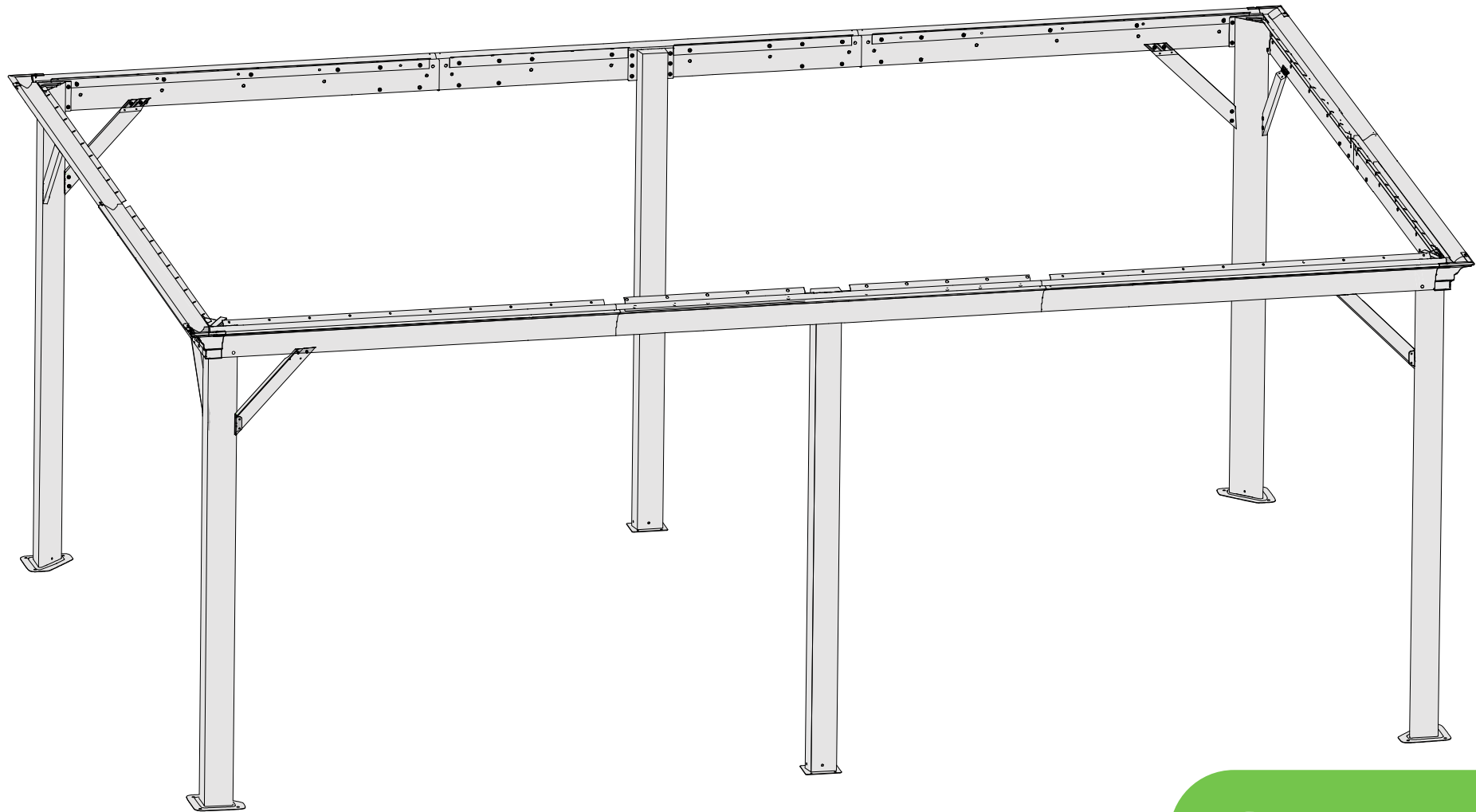

STEP 1

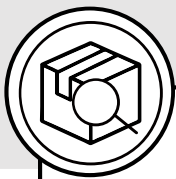

A × 4

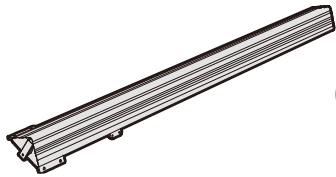

L × 4

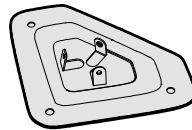

1# × 12

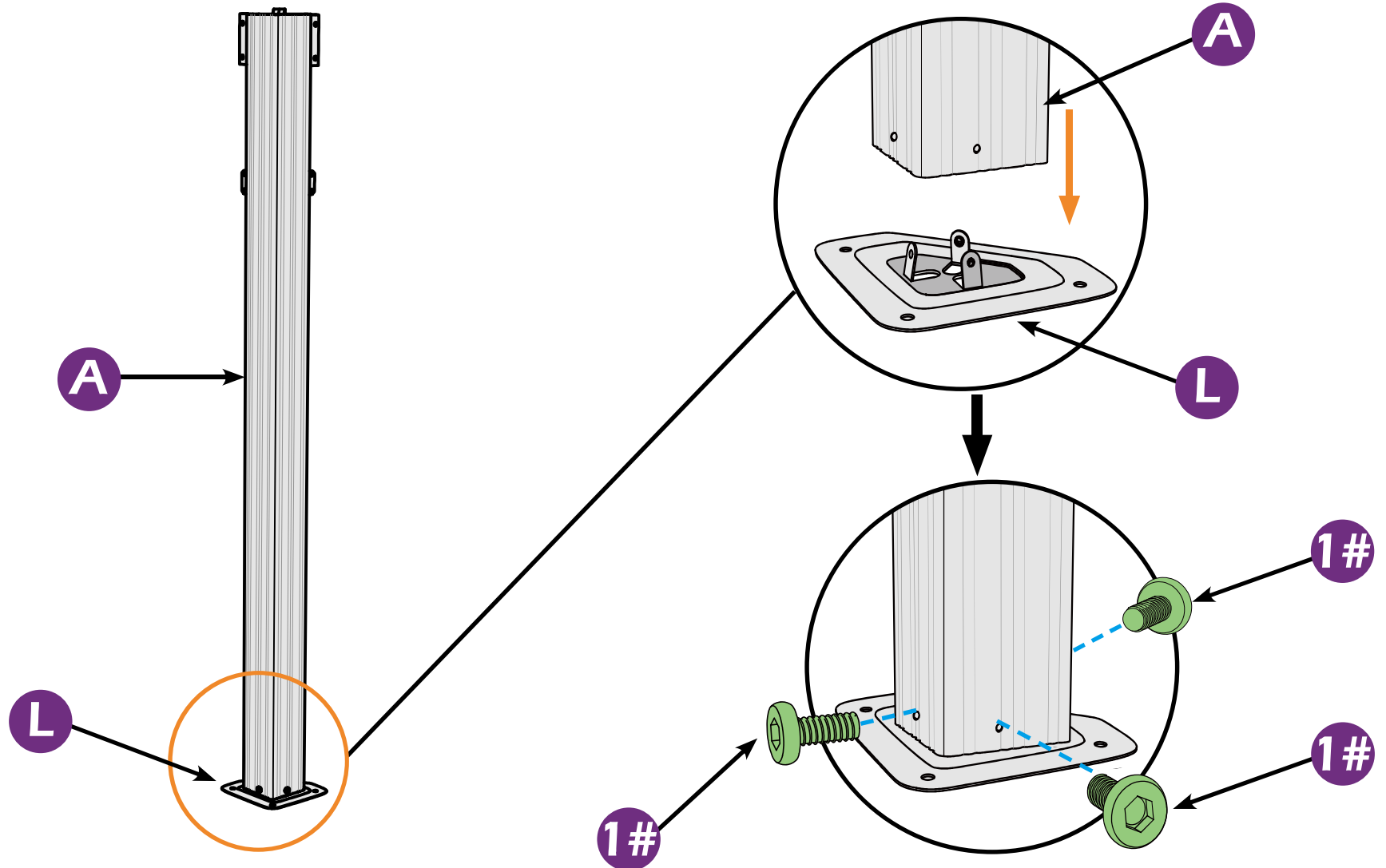
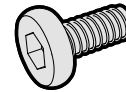

STEP 1

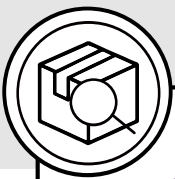

B × 2

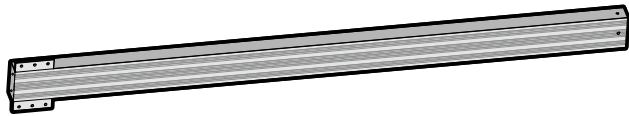

L1 × 2

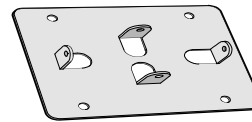

1# × 8

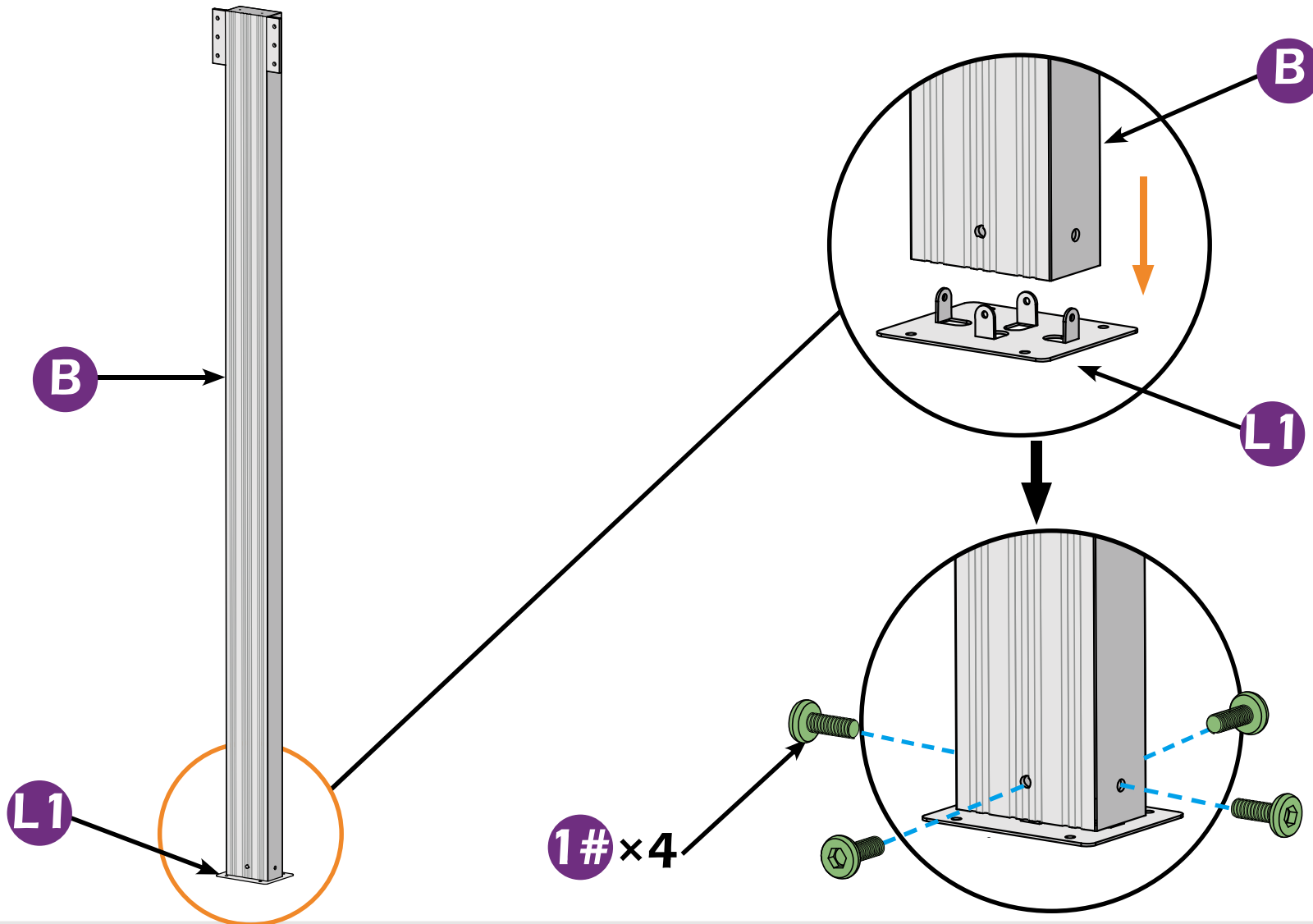
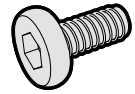

STEP 1

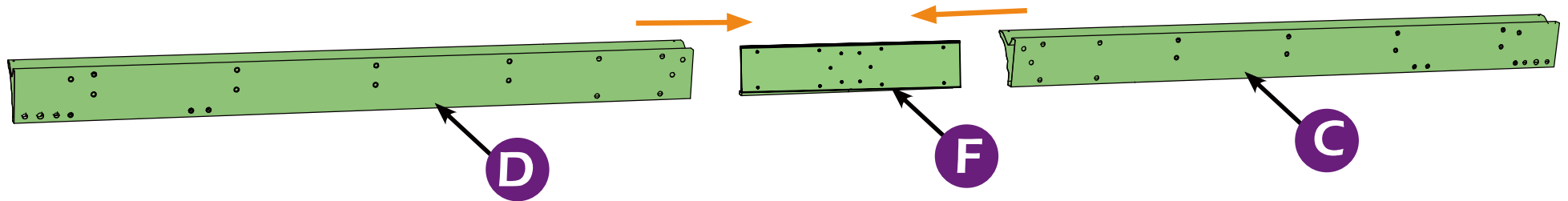
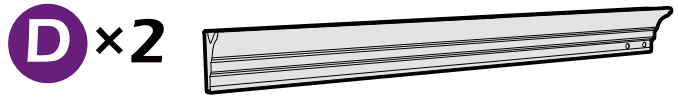
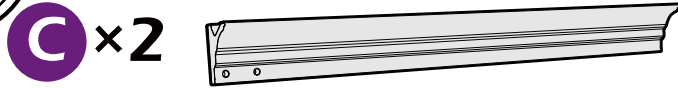

▲ It's a normal situation that there's a gap between the 2 beams, please use silicone sealant (part #H2) and bracket #H to affix the gap.(see P56–57)

STEP 1

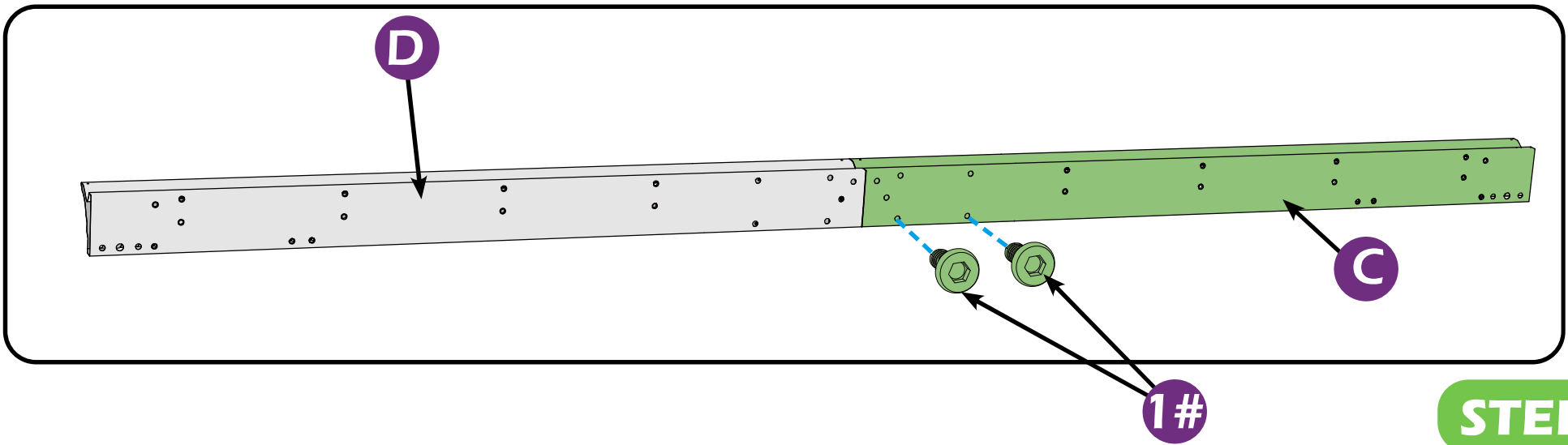
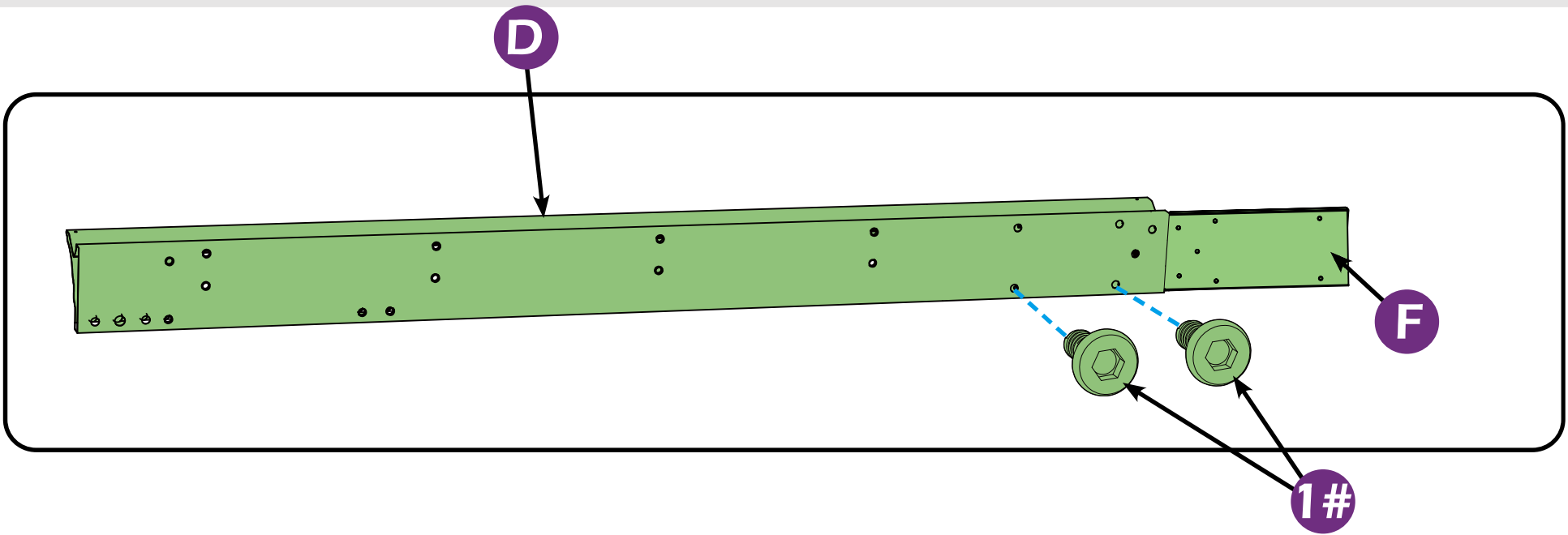

STEP 1

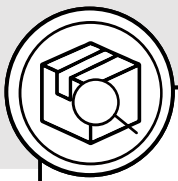

D2 × 2

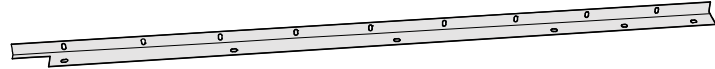

1# × 24

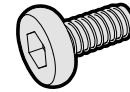

C2 × 2

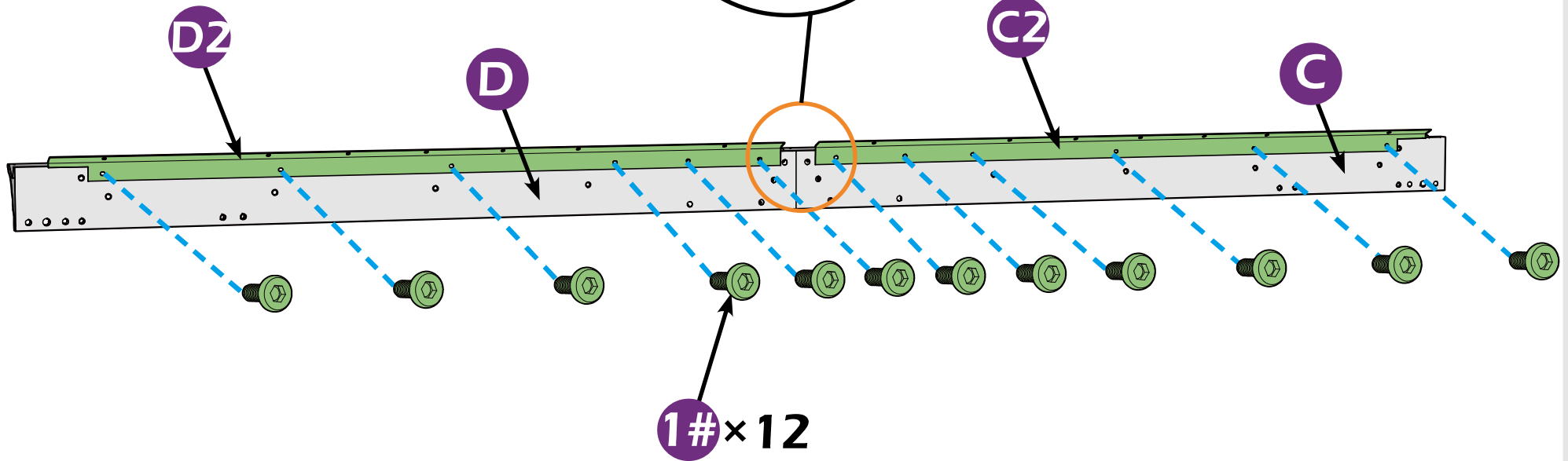
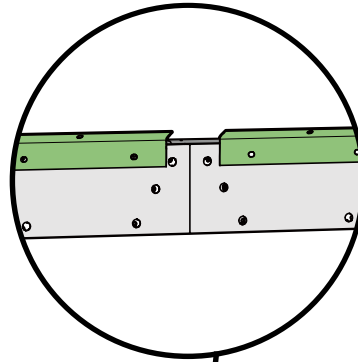
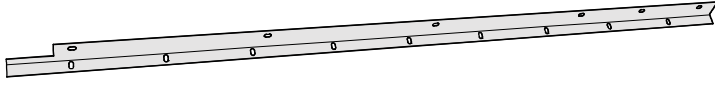

STEP 1



C × 2



F × 4

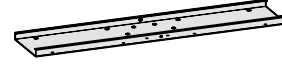

D × 2



1# × 16

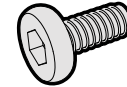

E × 2

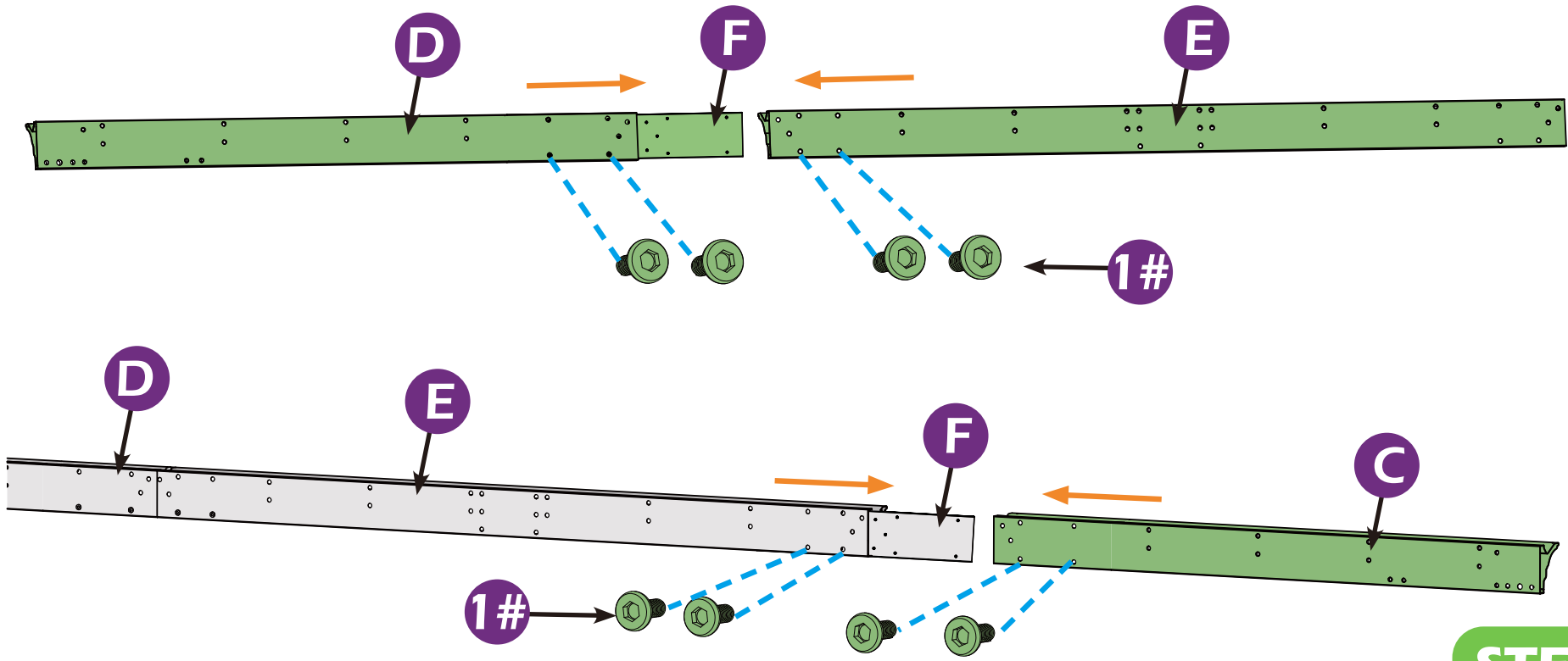
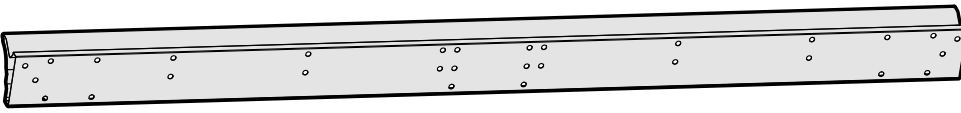

STEP 1

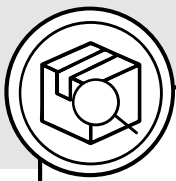

2# × 28

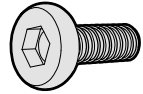

3# × 16

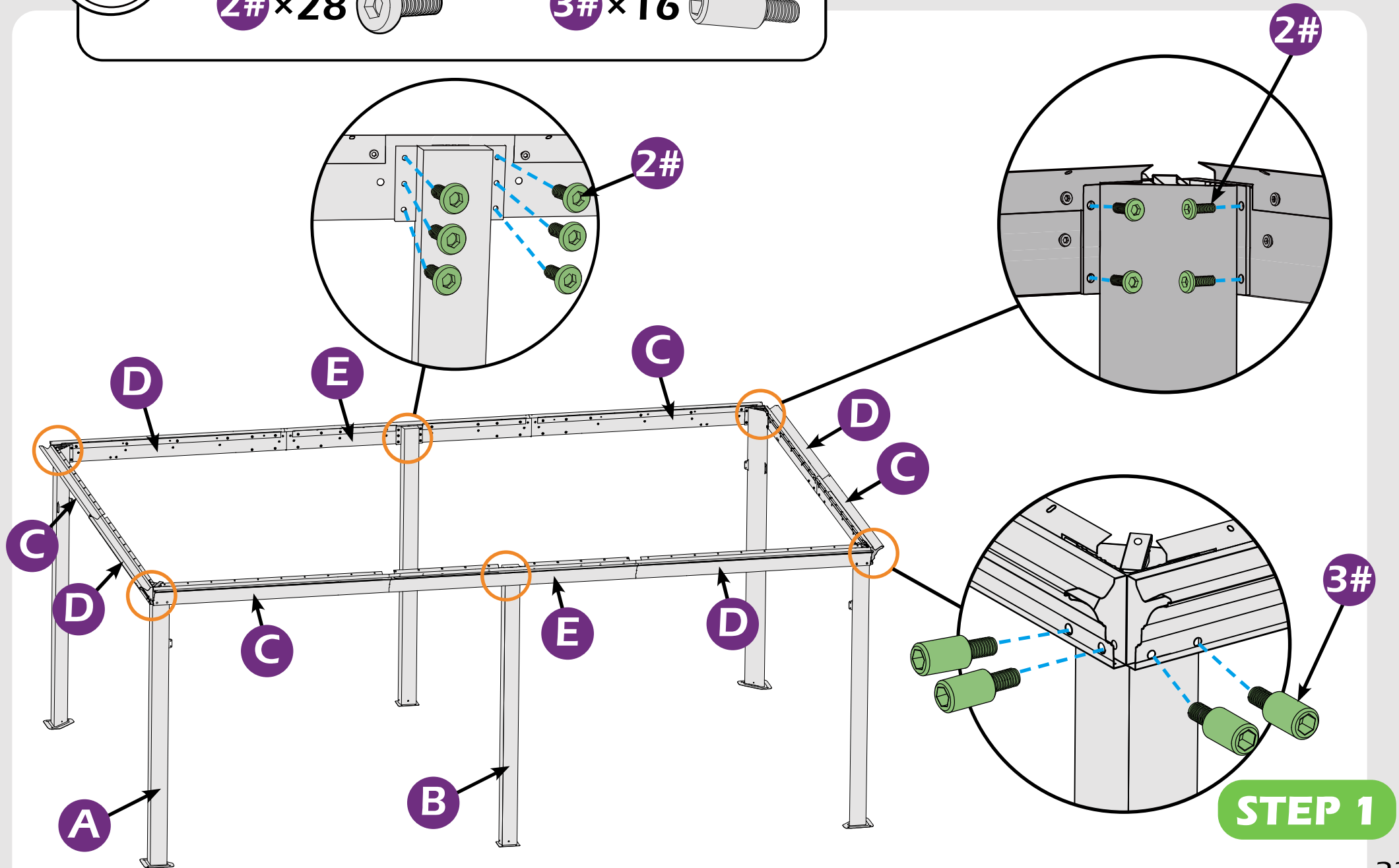
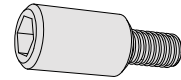

STEP 1

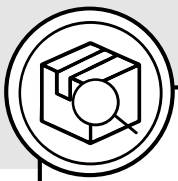

J1 × 4



1# × 32

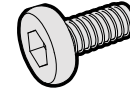

J2 × 4

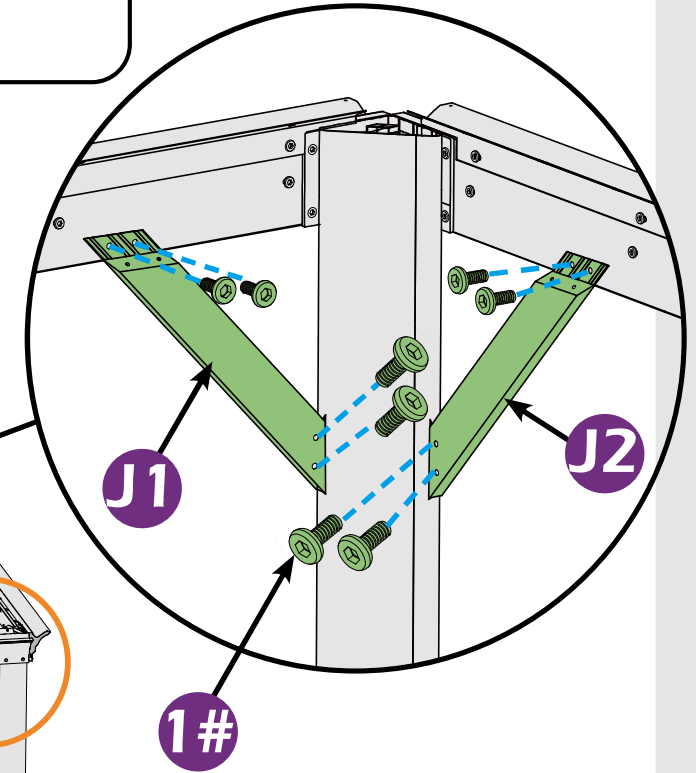
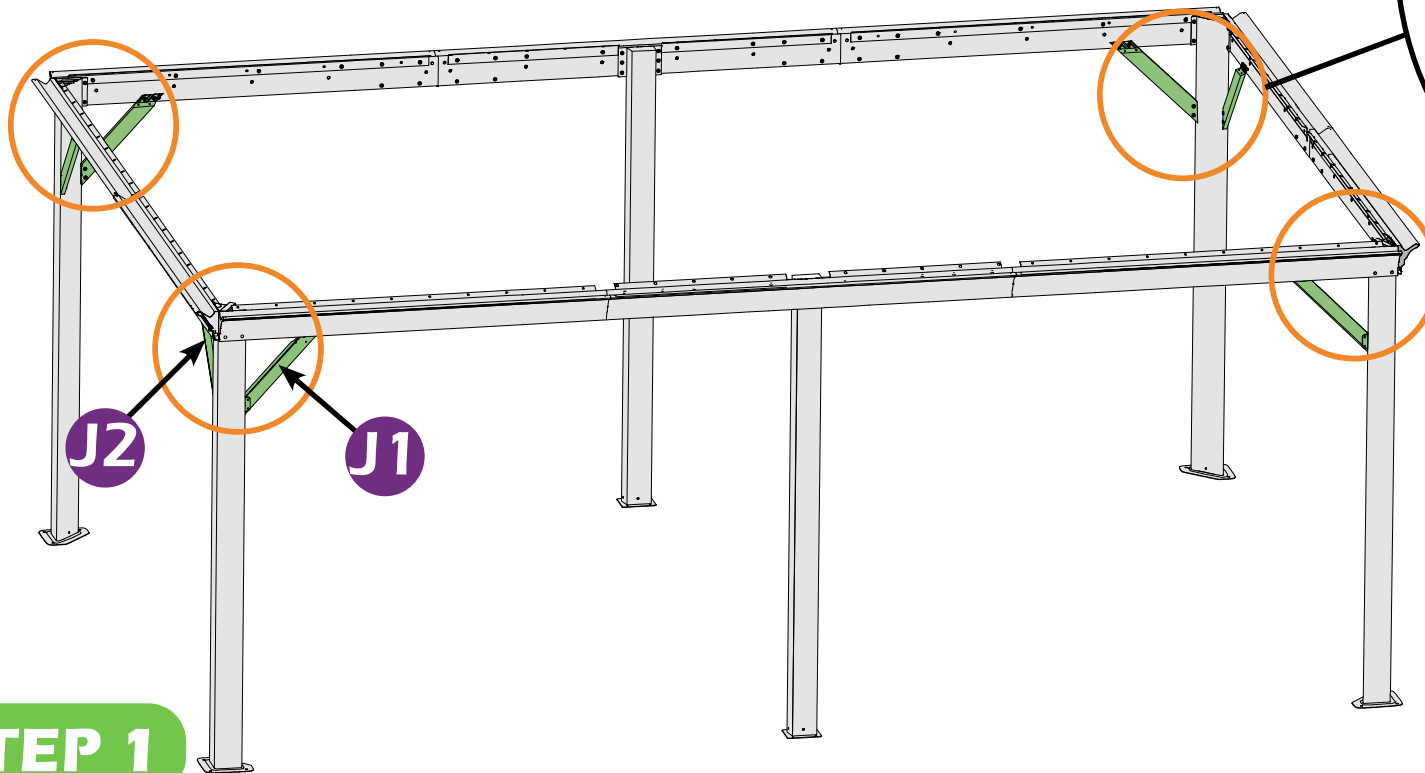

STEP 1

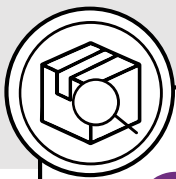

G × 4

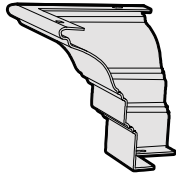

9# × 16

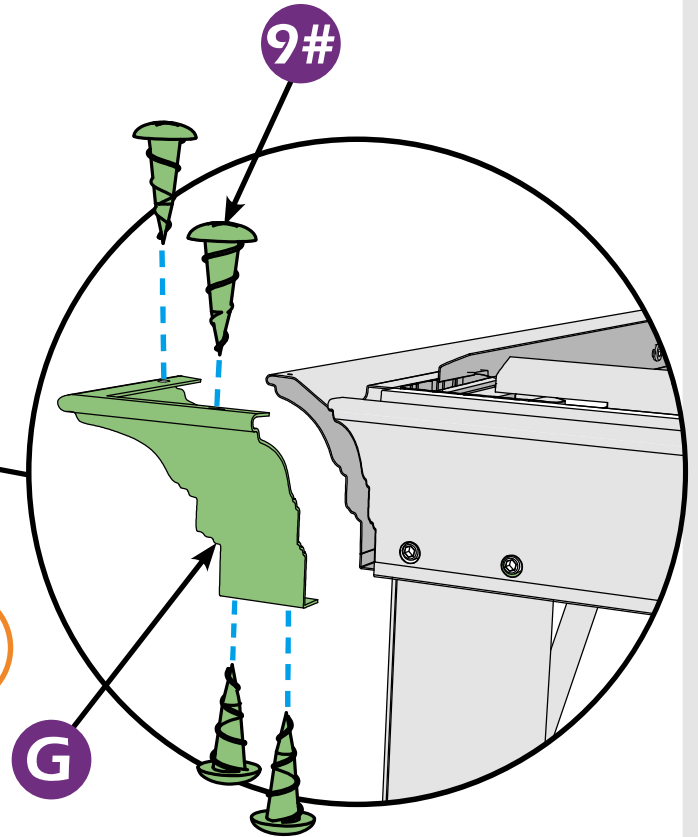
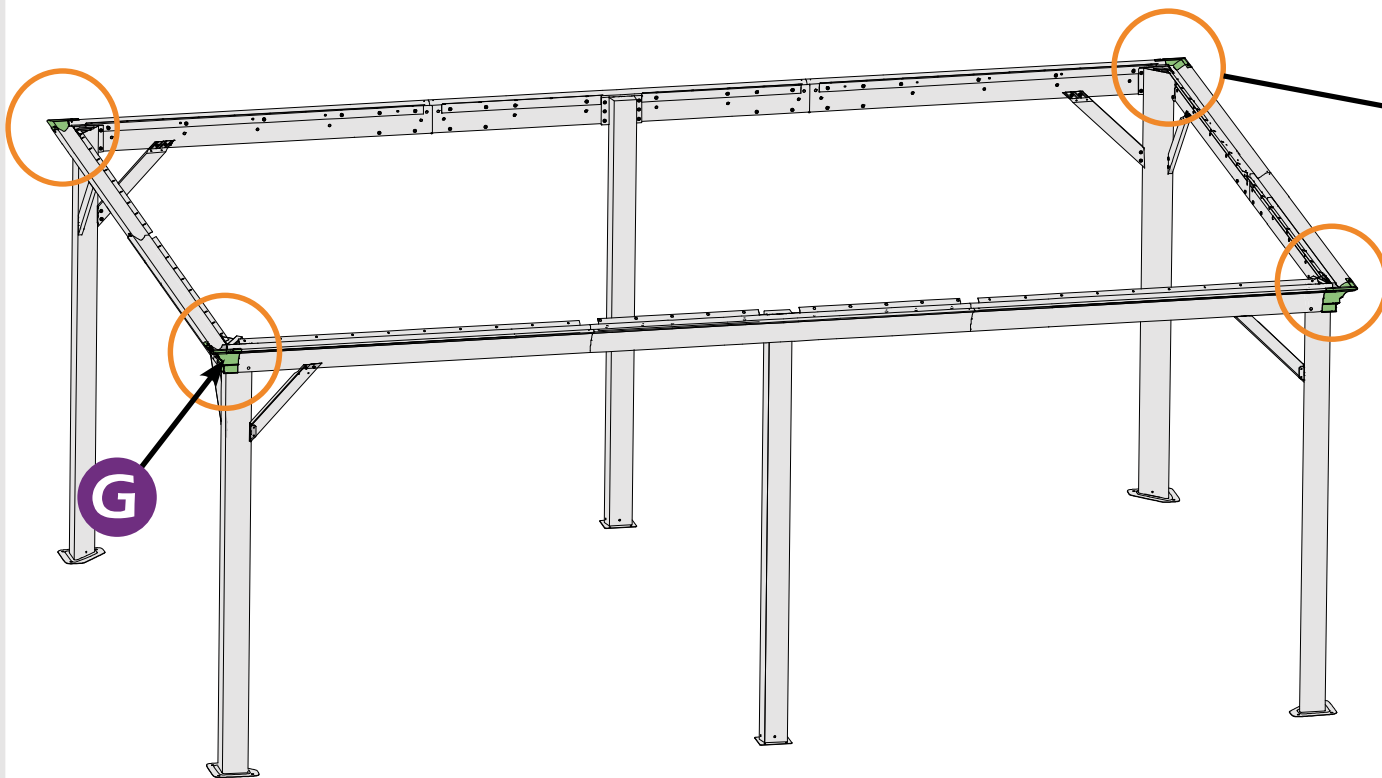
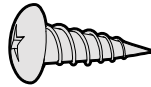

STEP 1

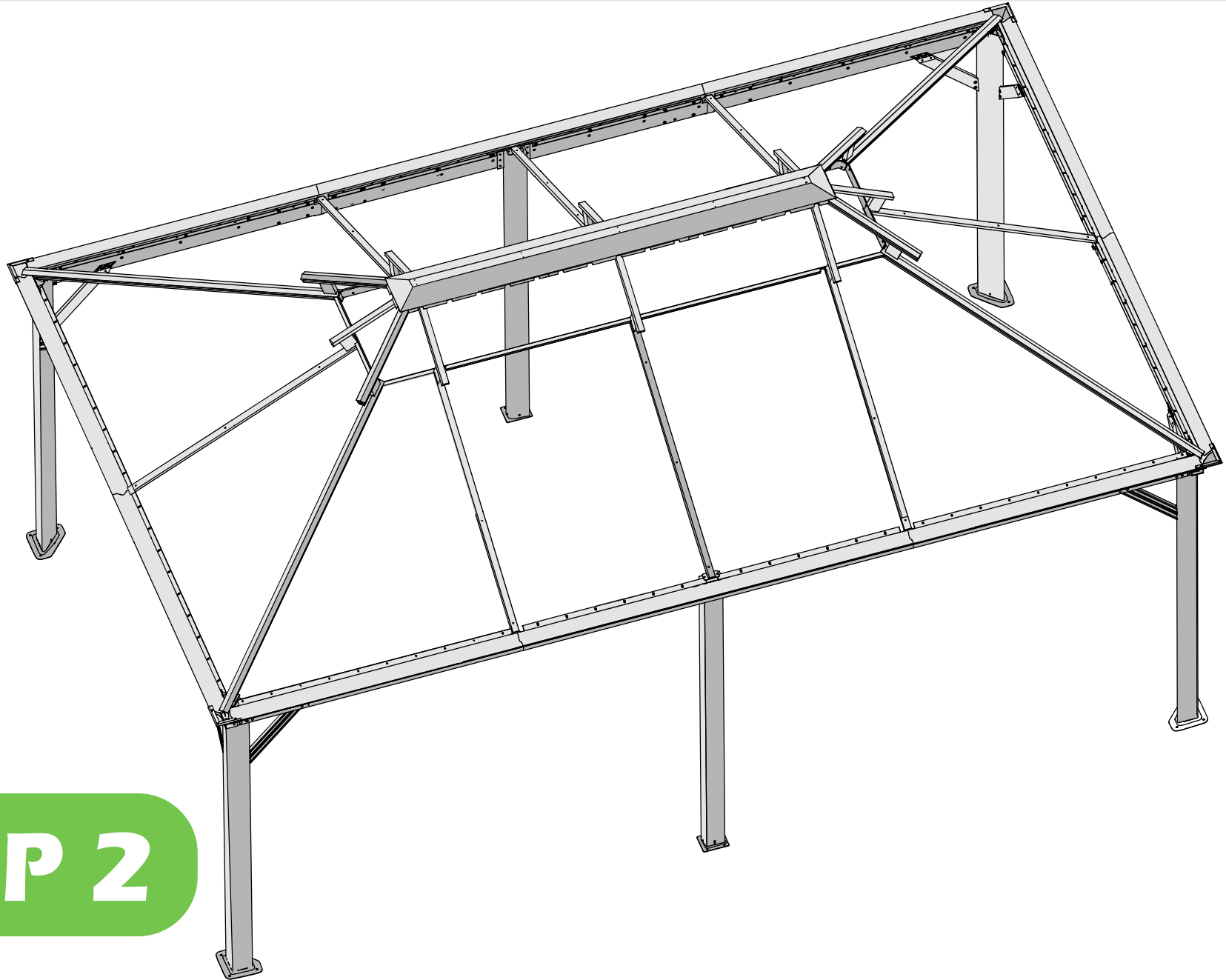

STEP 2

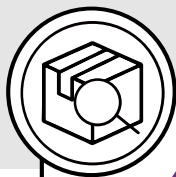

K × 1

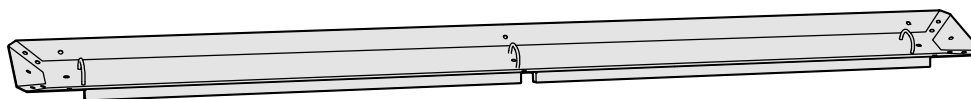

1# × 3

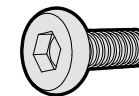

K1 × 1

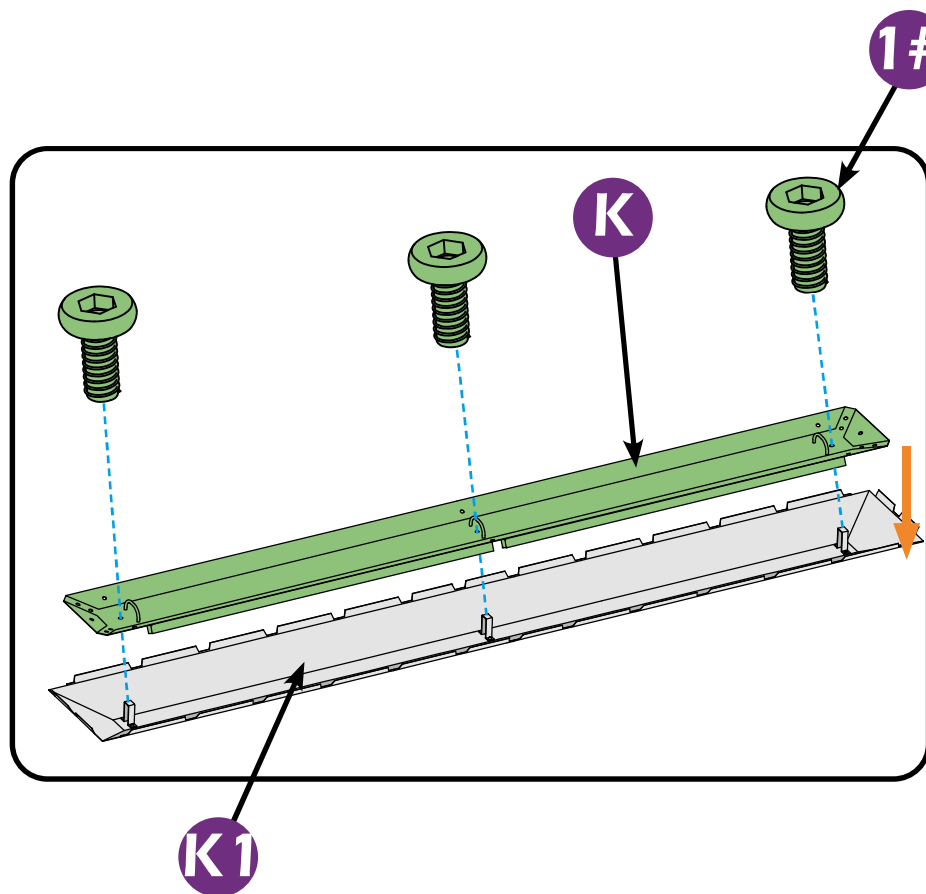
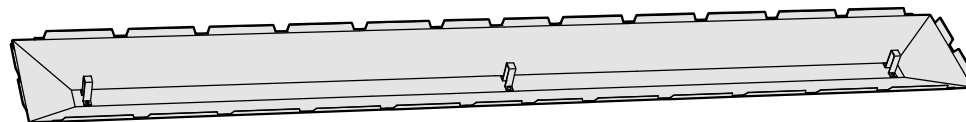

Don't fully tighten the screw **1#**, It might cause problem on roofs installation.

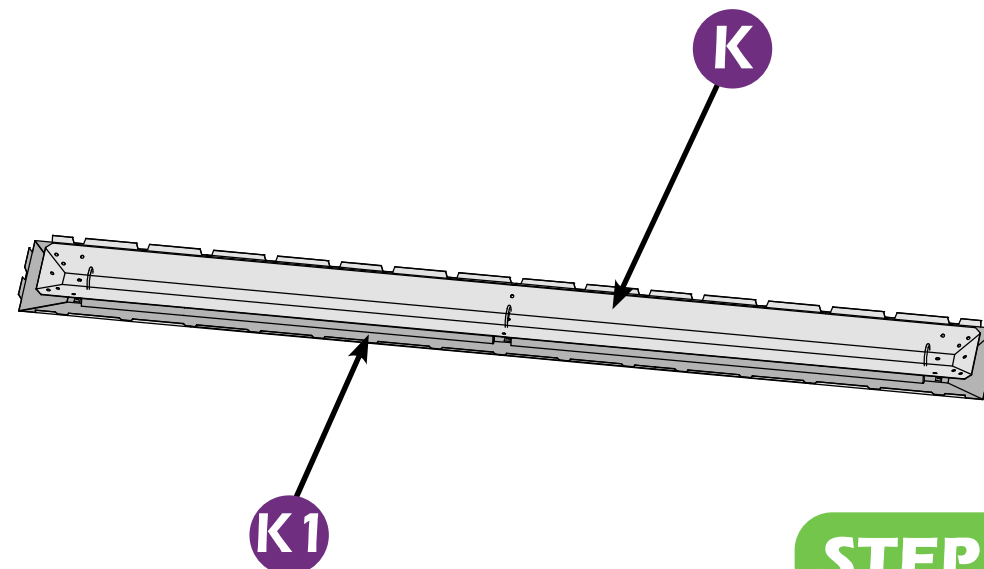

STEP 2



Ma x4



Mb x4



2# x8

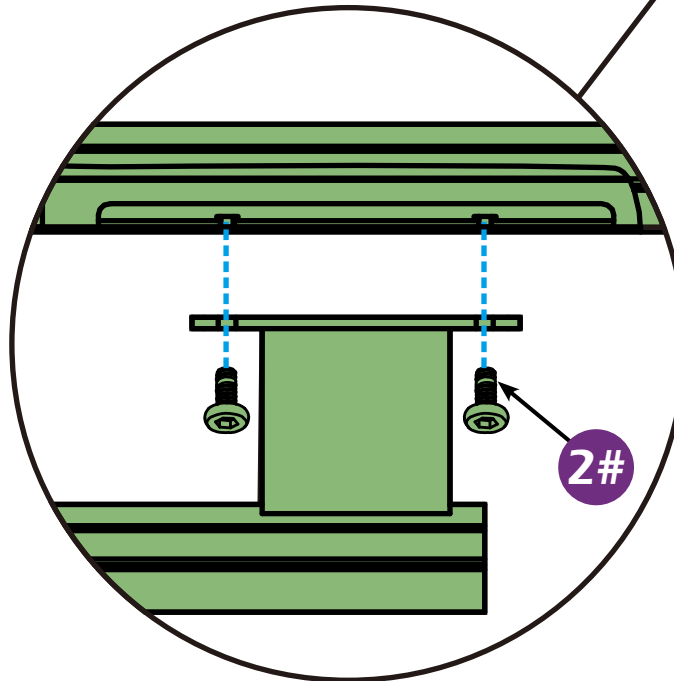
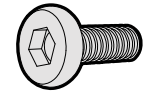

STEP 2

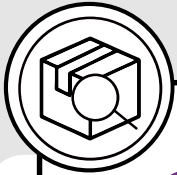

M_(Ma+Mb) × 1



N × 1



1# × 3

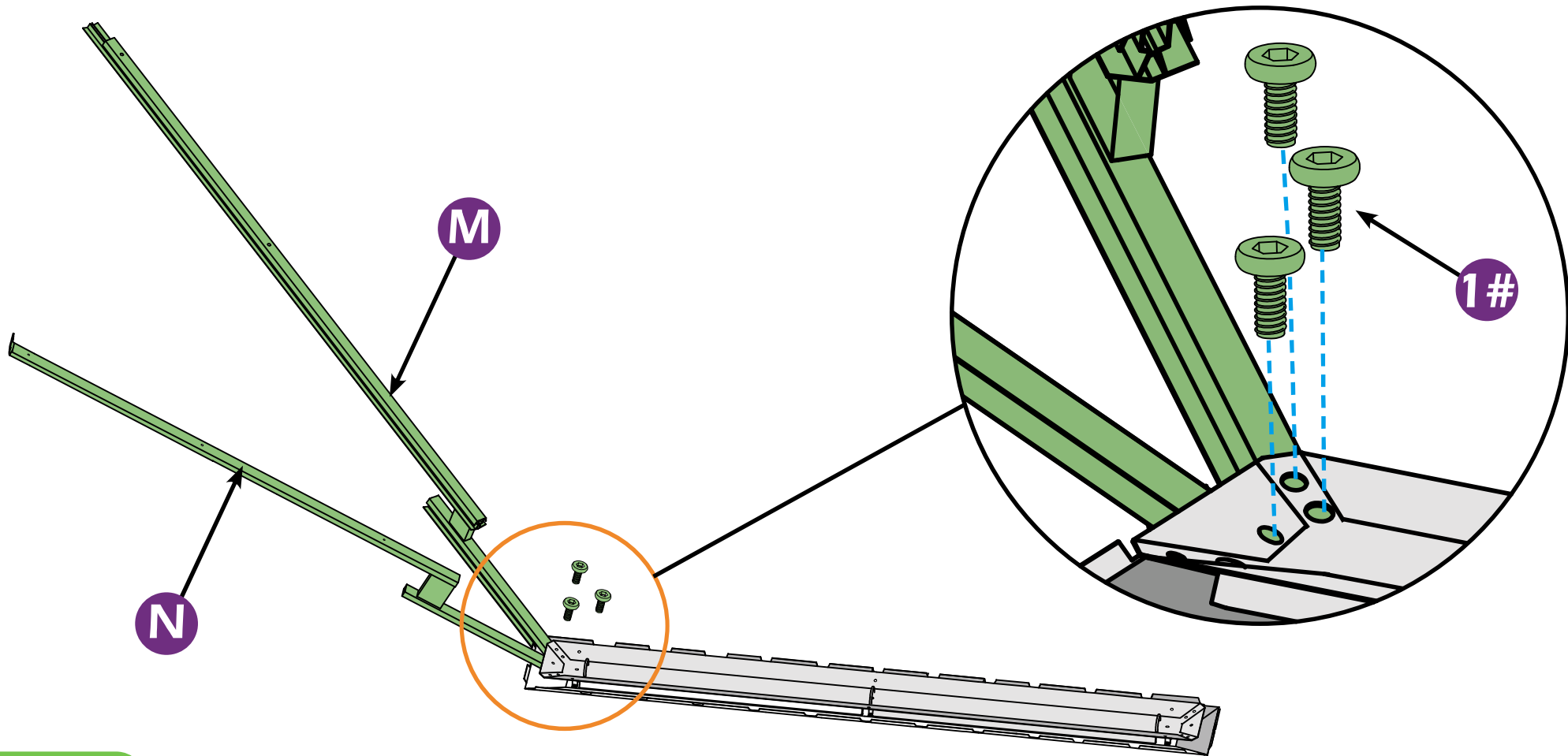
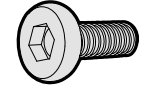

STEP 2

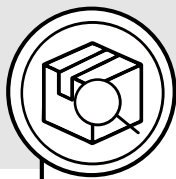

1# x 3

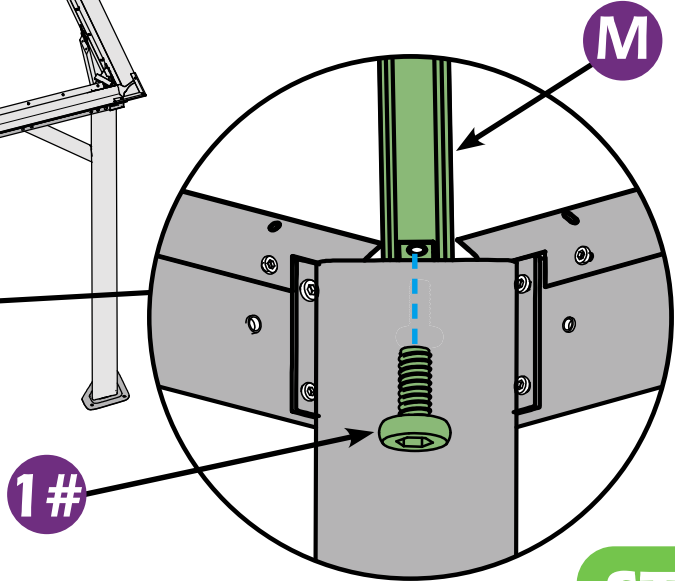
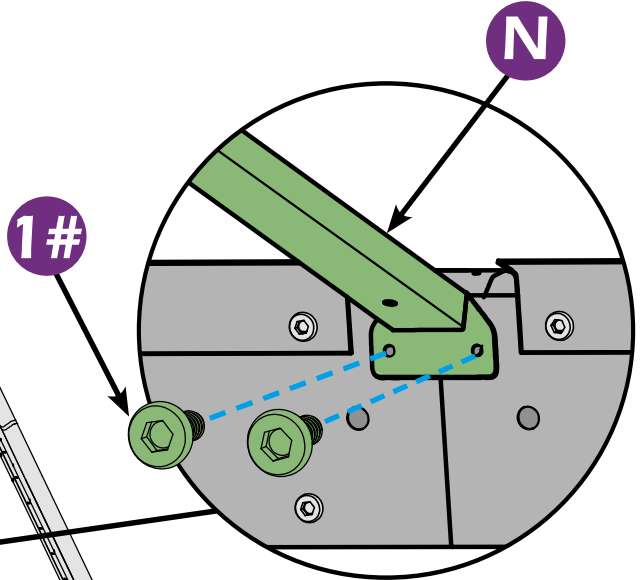
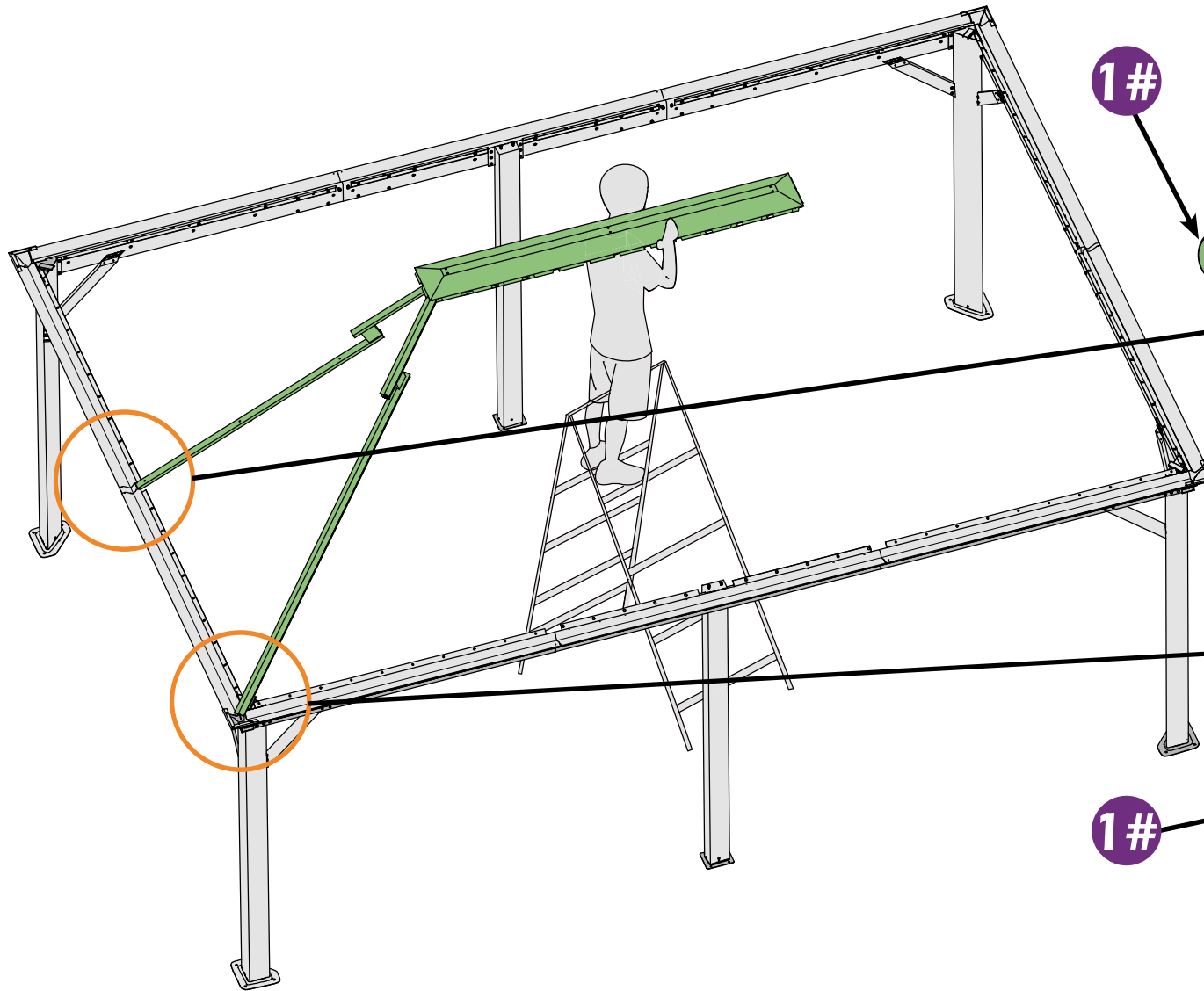
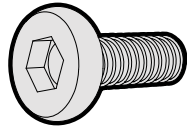

STEP 2

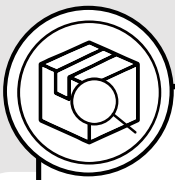

M × 3



1# × 9

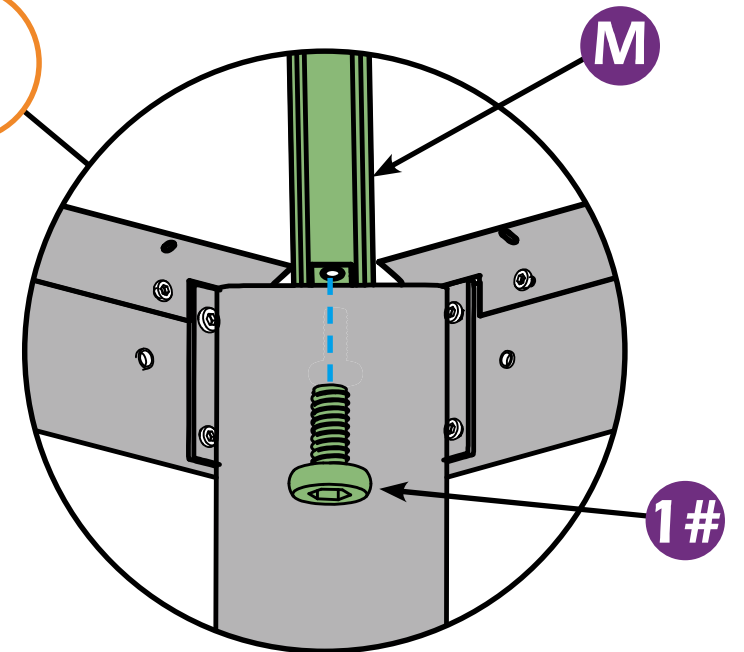
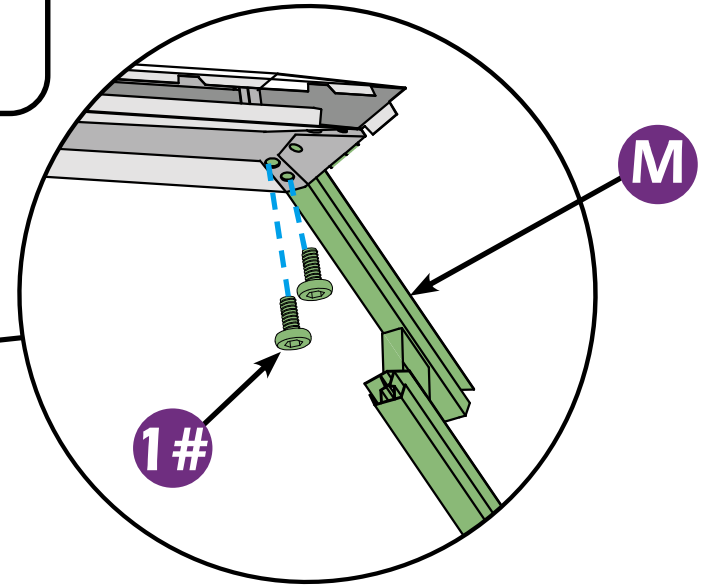
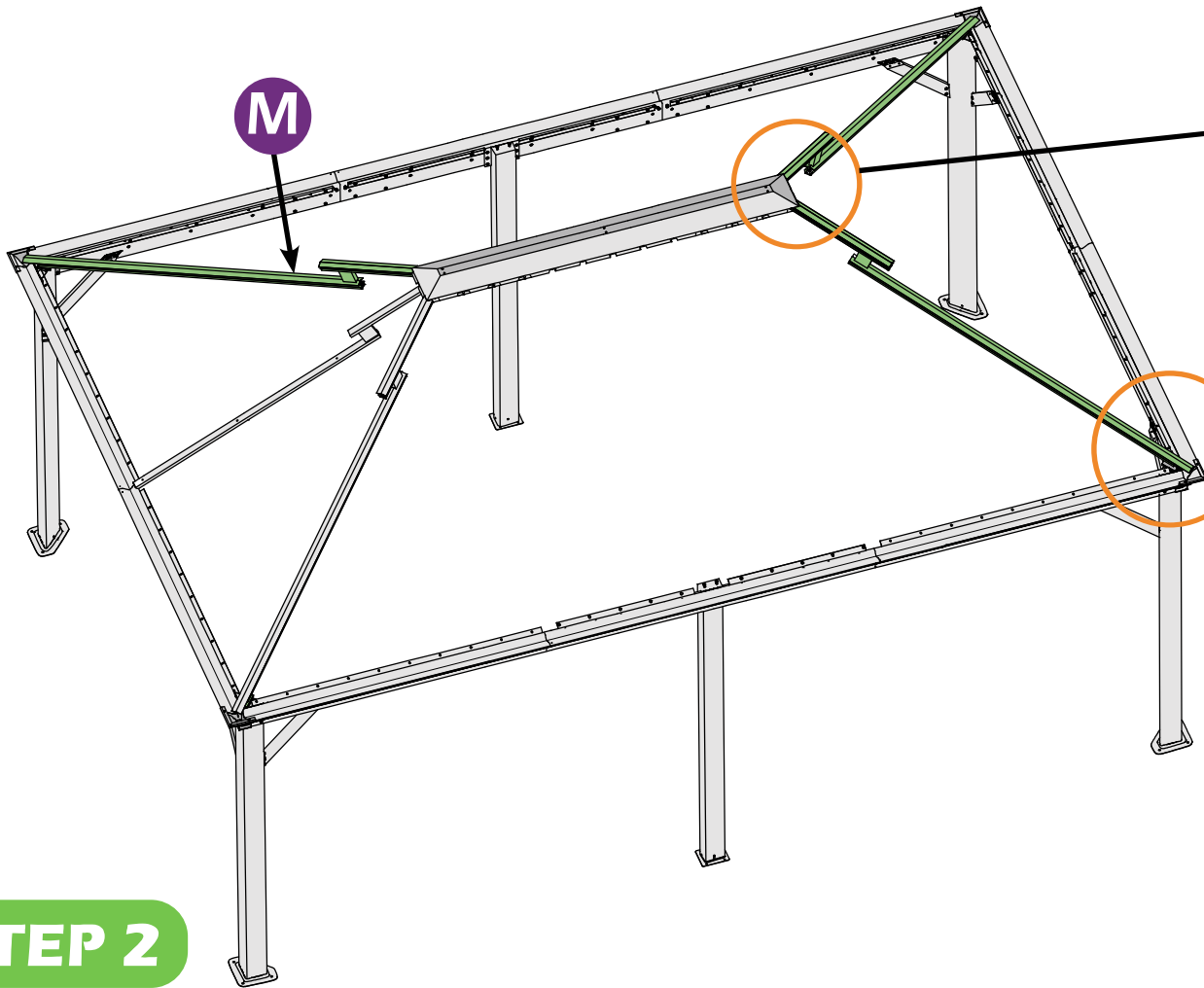
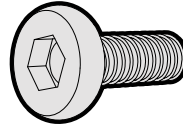

STEP 2

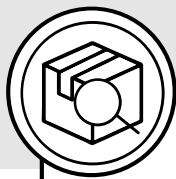

N × 1



1# × 3

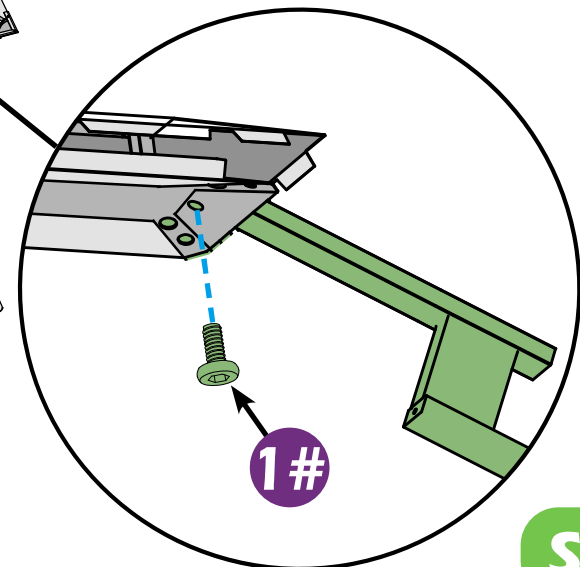
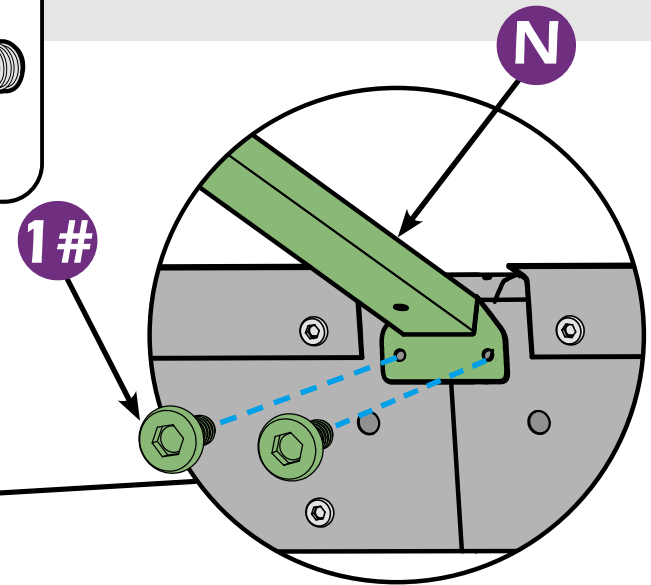
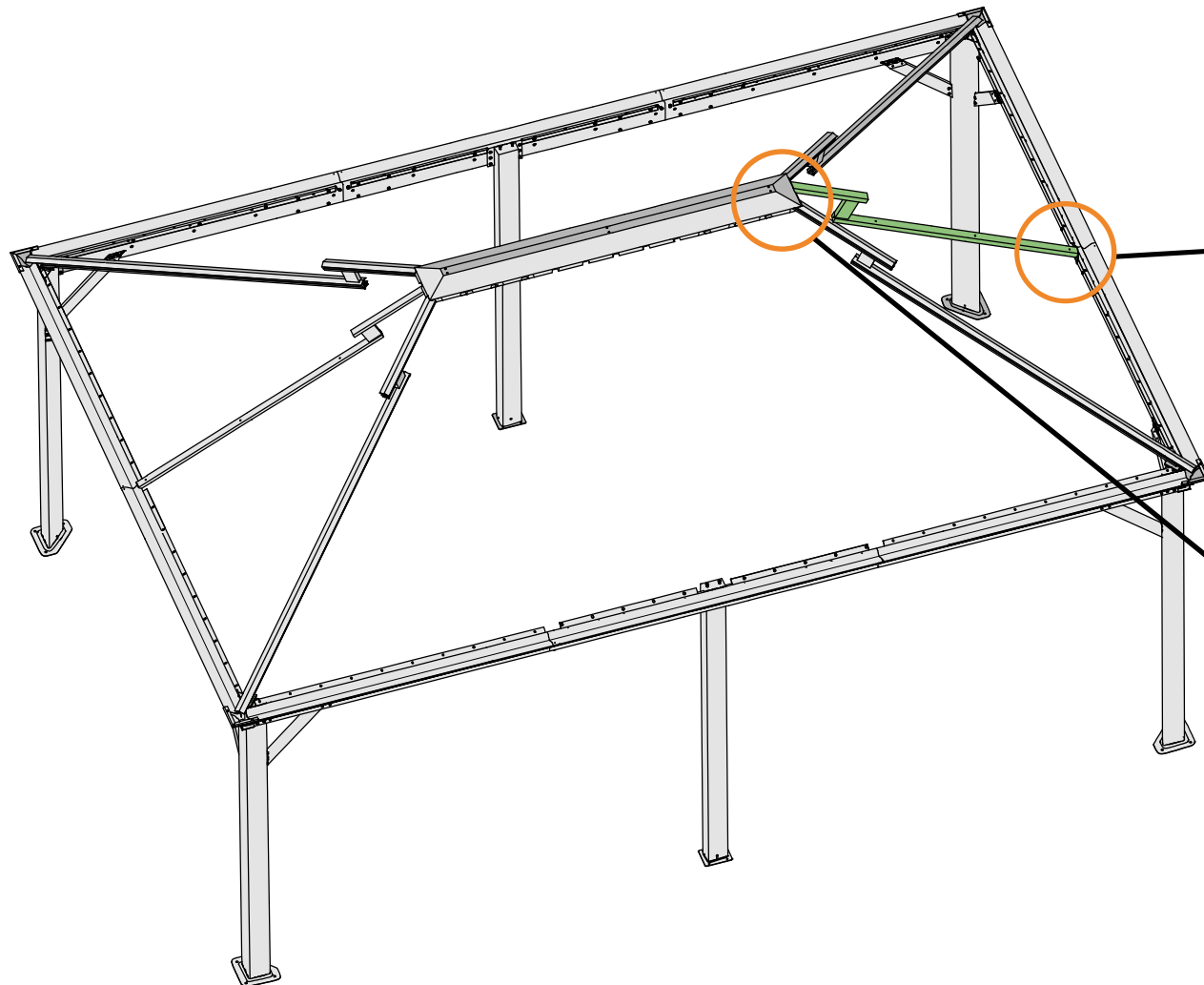
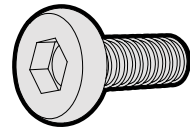

STEP 2

Check the the frame as pictures below shows.

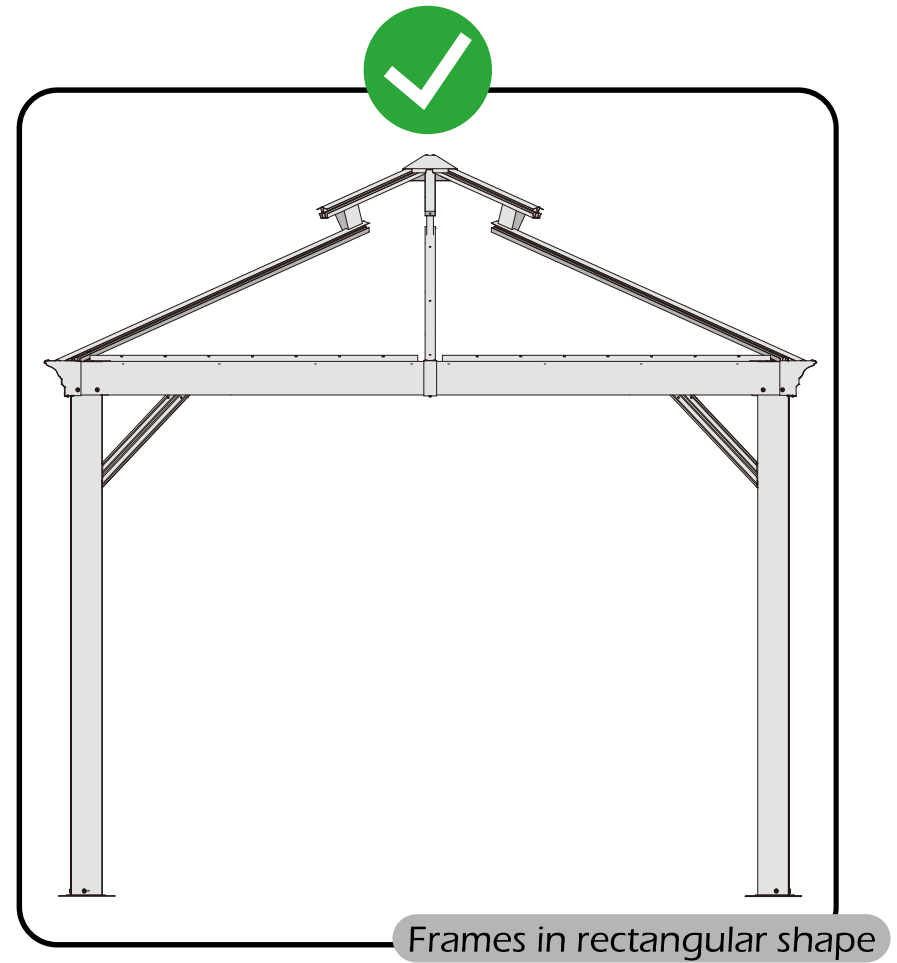
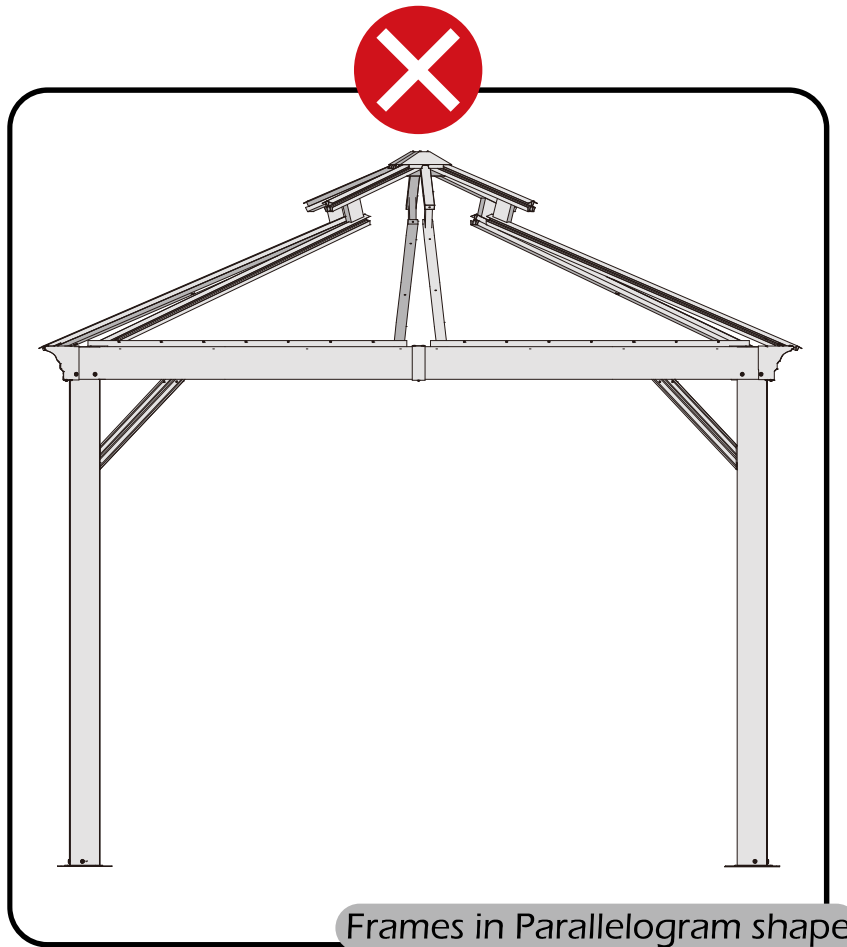

STEP 2

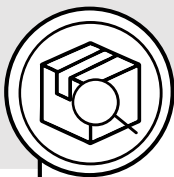

N1 × 4



1# × 18

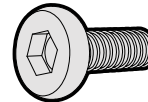

N2 × 2

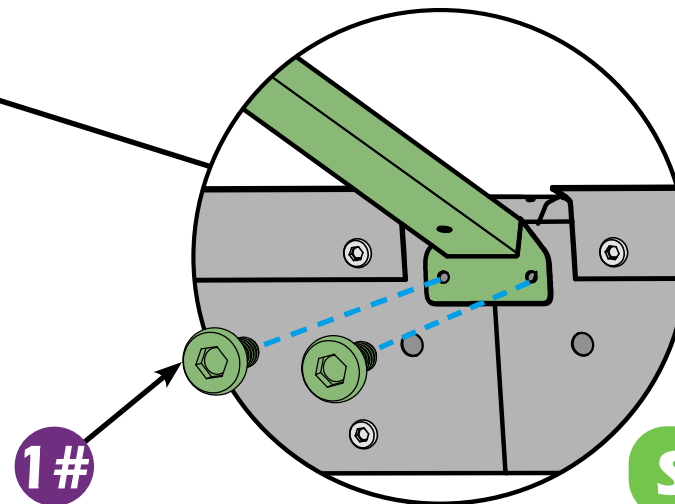
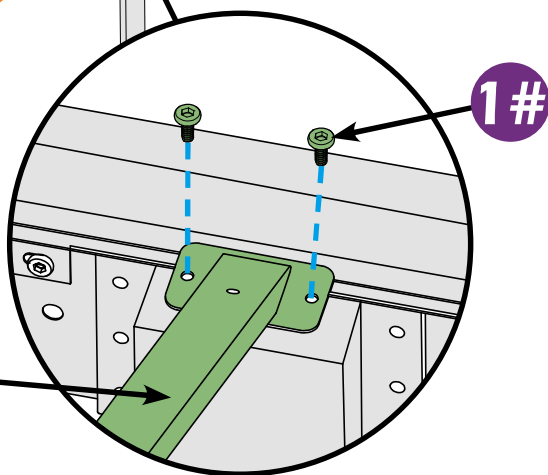
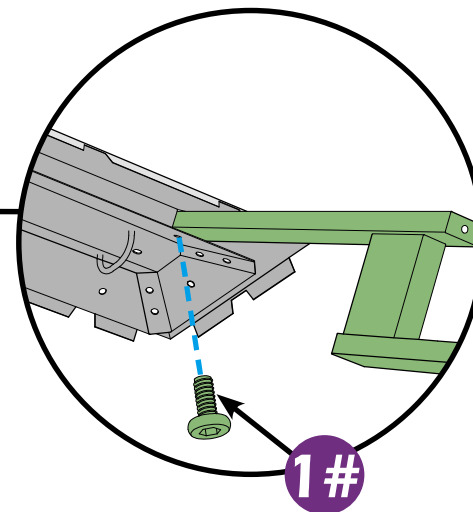
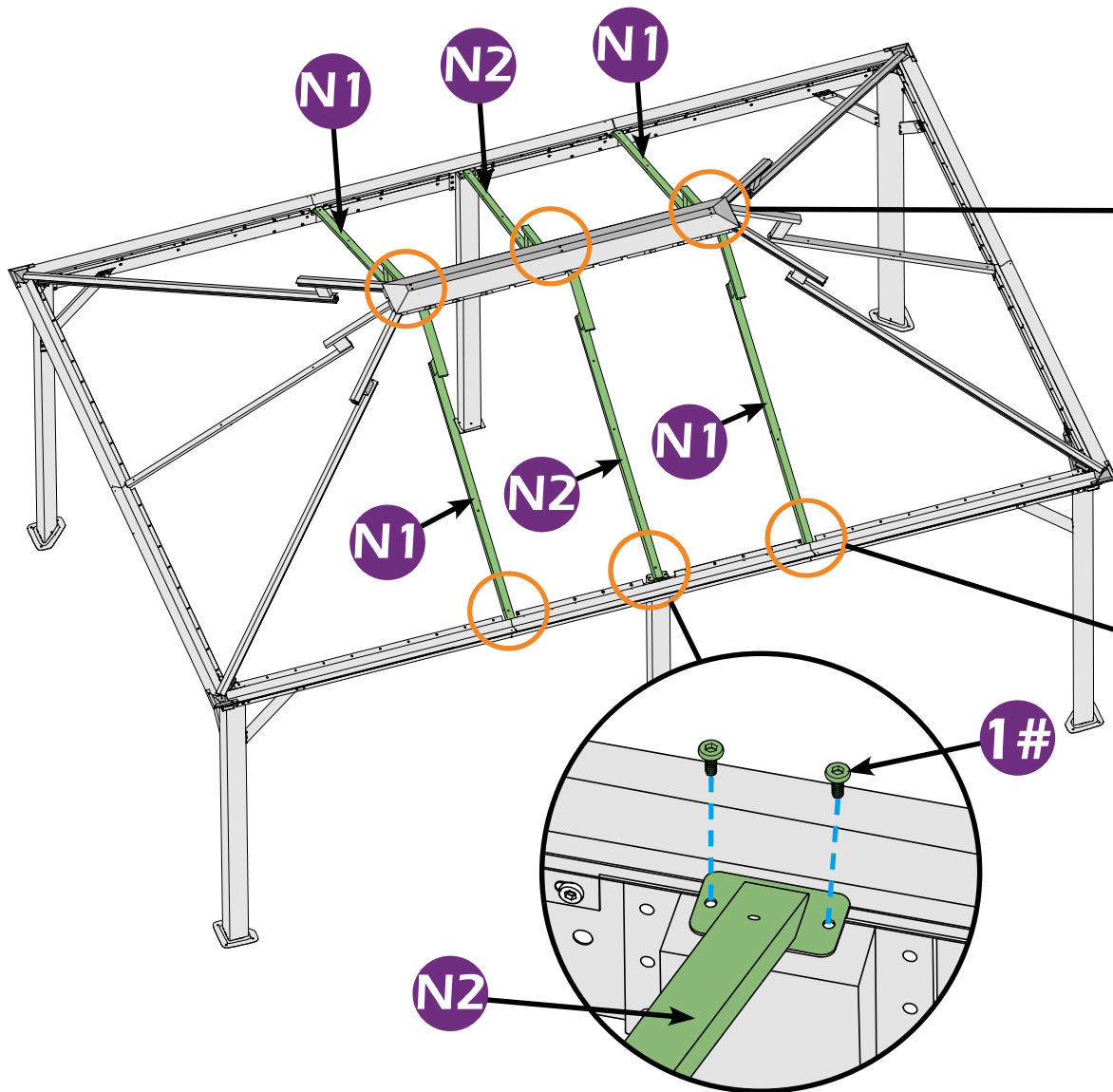
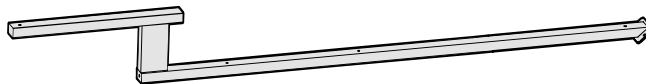

STEP 2

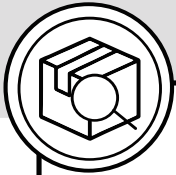

P × 2

R × 4

1# × 4

Q1 × 2

Q2 × 2

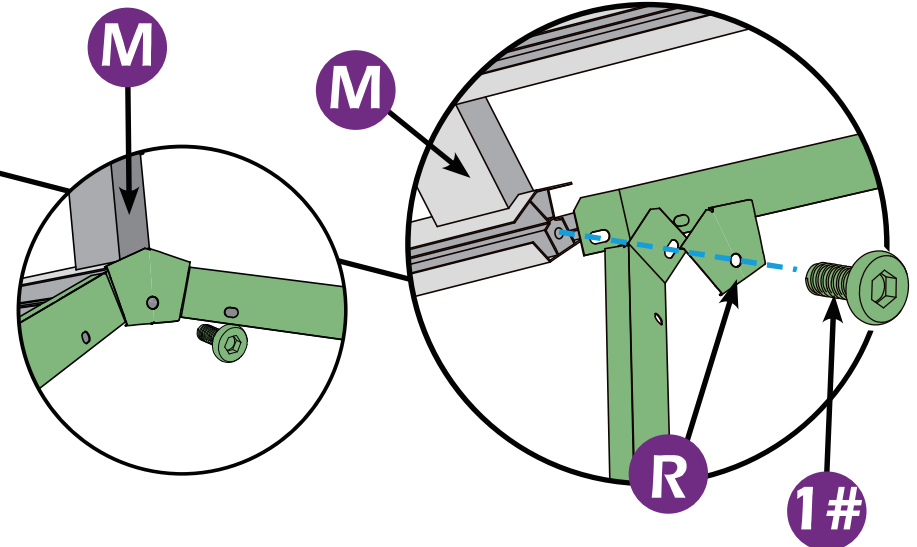
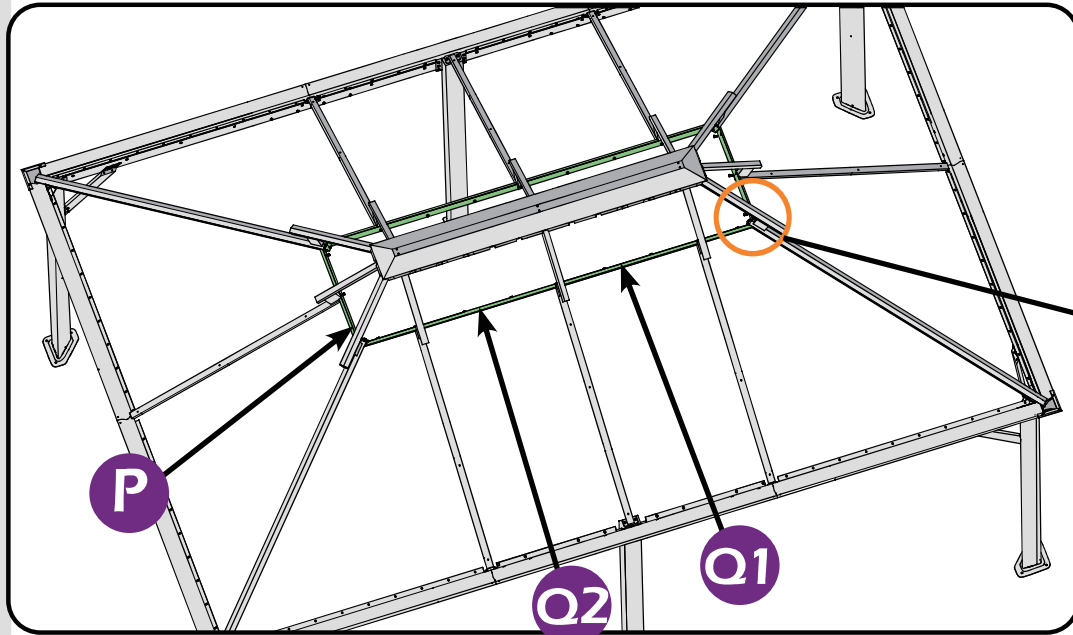

STEP 2

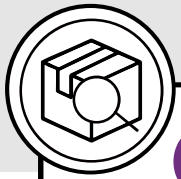

P1 × 2

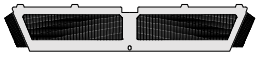

Q3 × 2

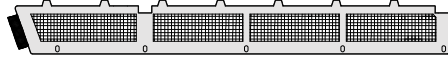

Q4 × 2

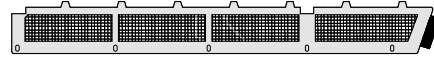

1# × 8

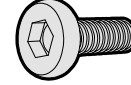

11# × 16

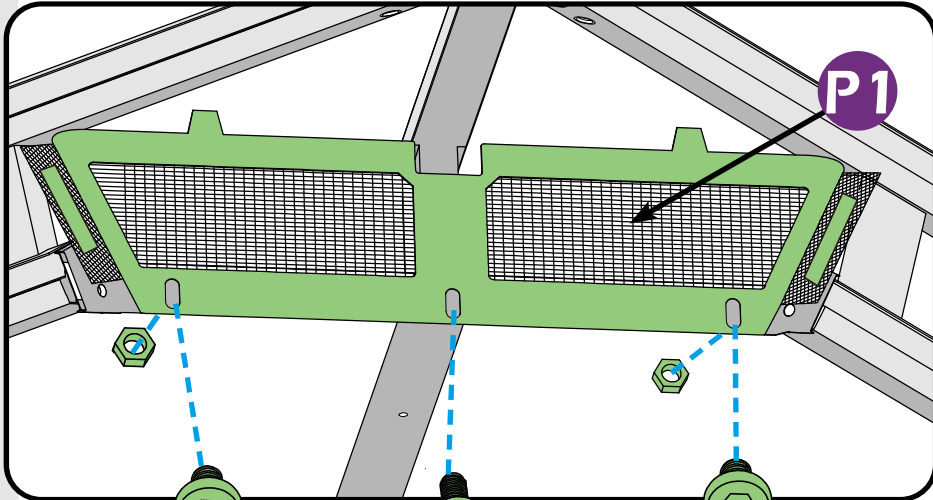
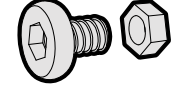

P1

11#

1#

11#

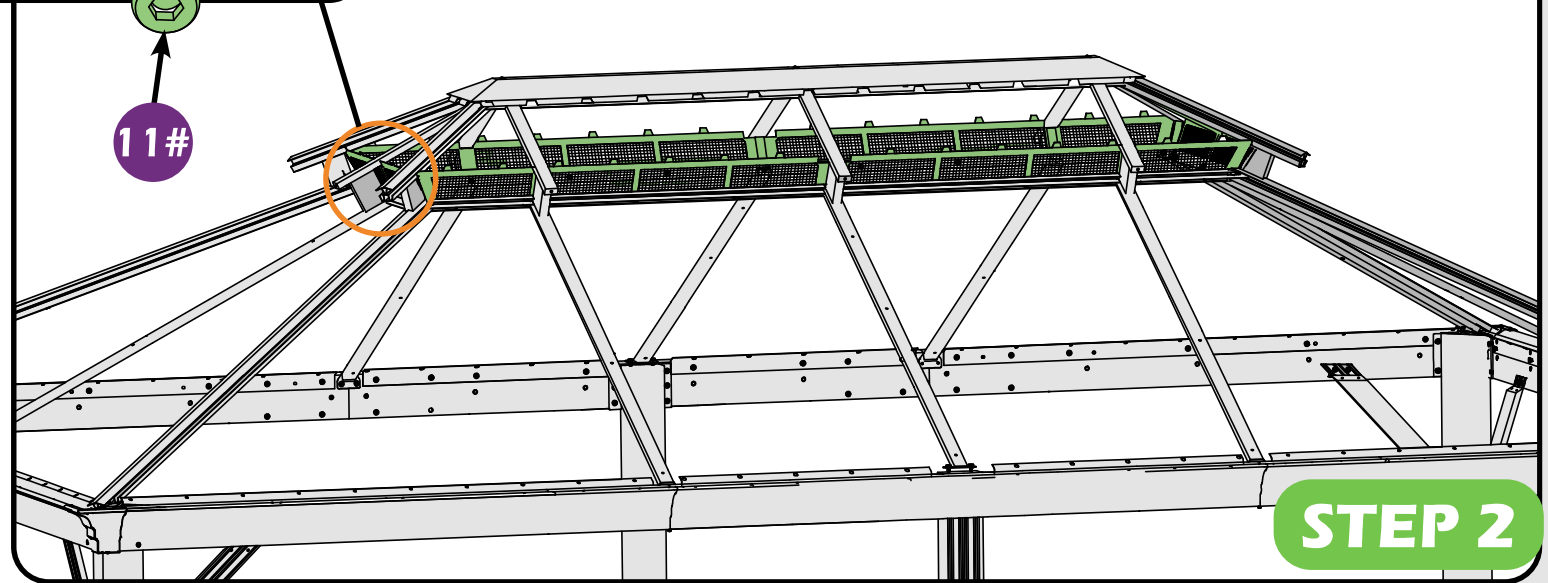

STEP 2

Q3

Q4

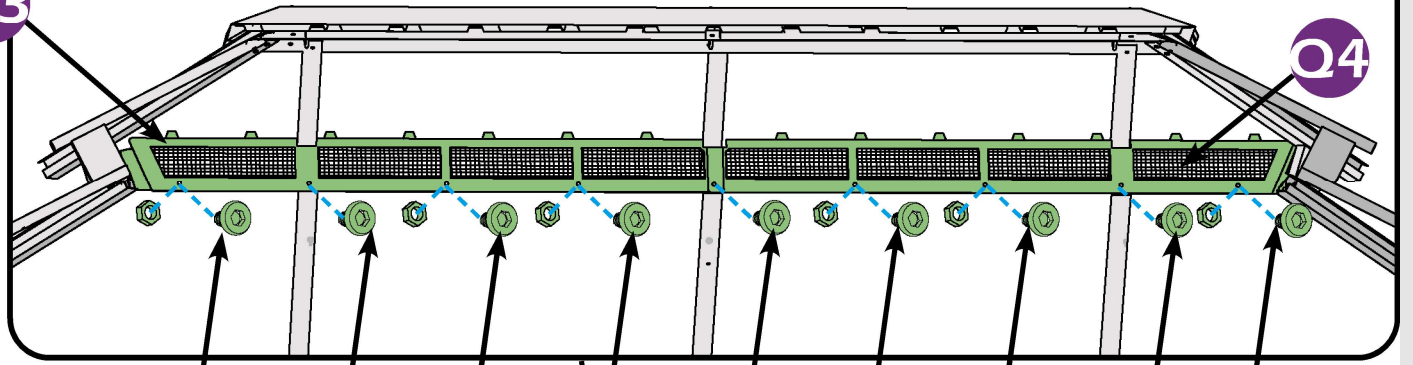

11#

1#

11#

11#

1#

11#

11#

1#

11#

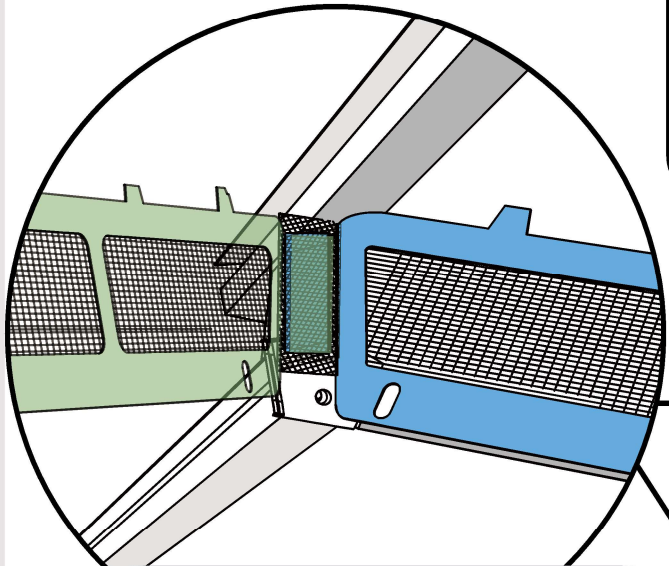

Don't forgot to stick the velcro between the bug netting

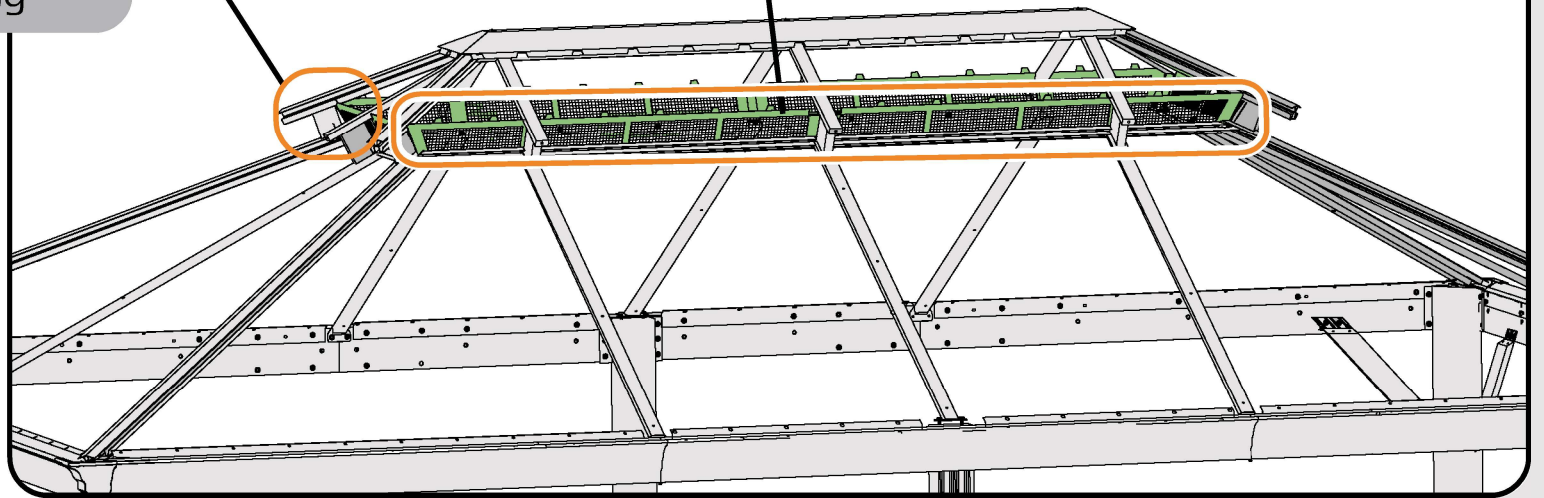

STEP 2

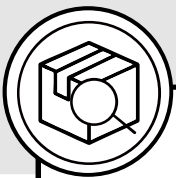

T × 2



R × 4

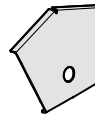

R1 × 2

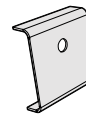

1# × 8

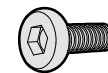

T1 × 2



T2 × 2

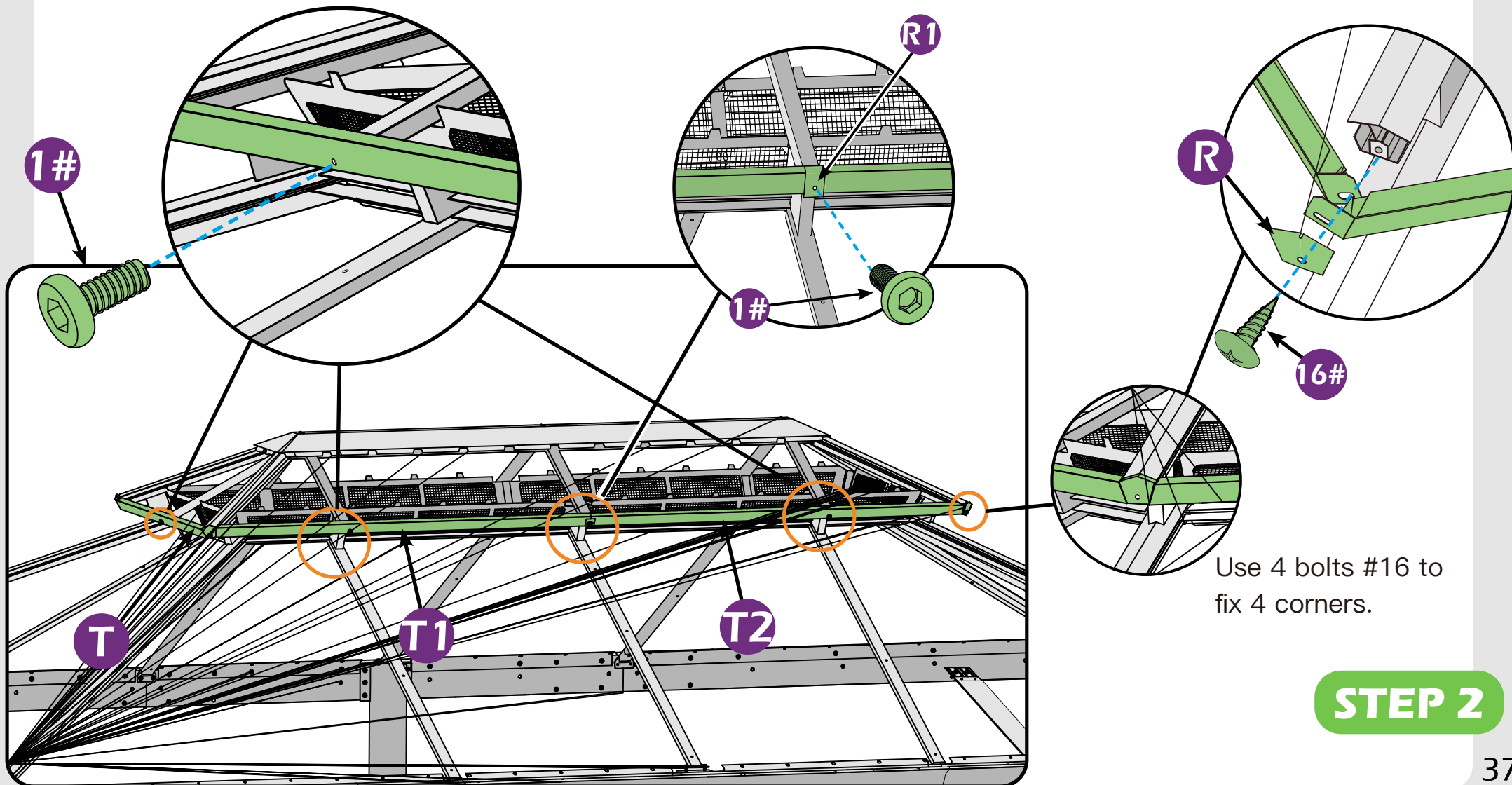
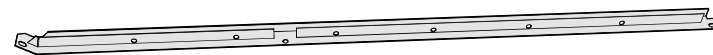

Use 4 bolts #16 to fix 4 corners.

STEP 2

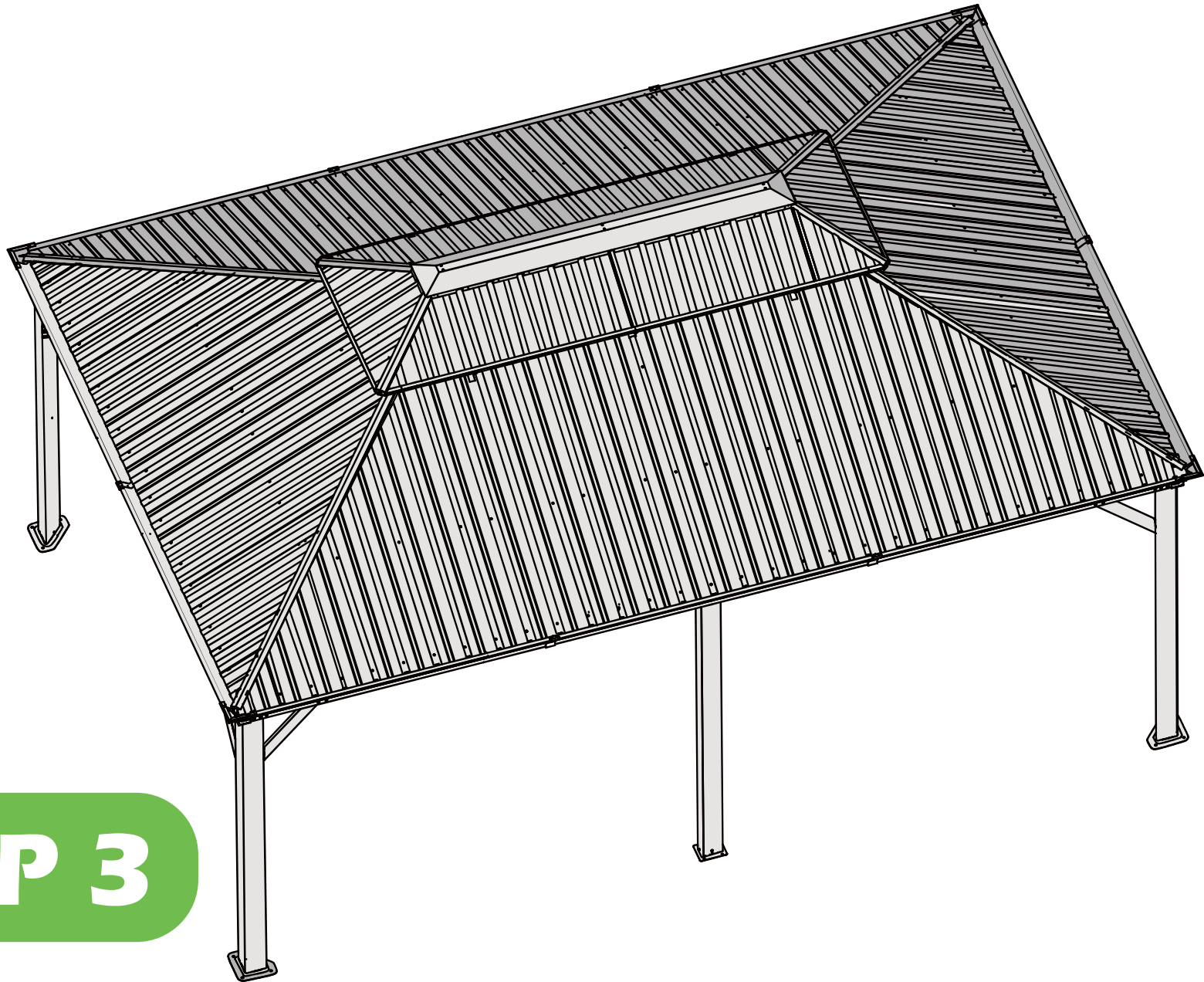

STEP 3

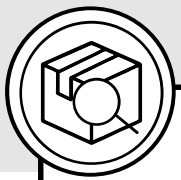

V1 x 2

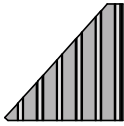

V2 x 2

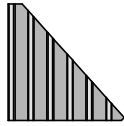

Z1 x 4



Z x 4





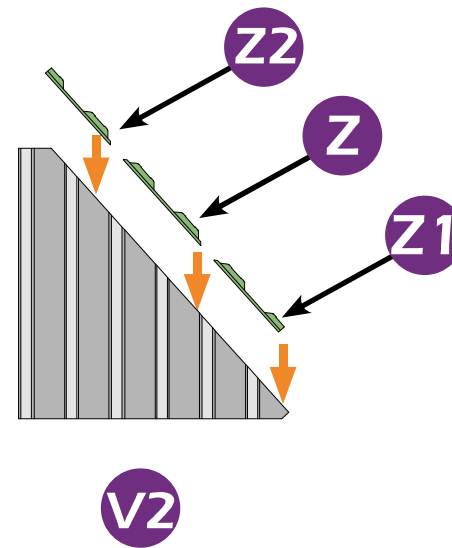
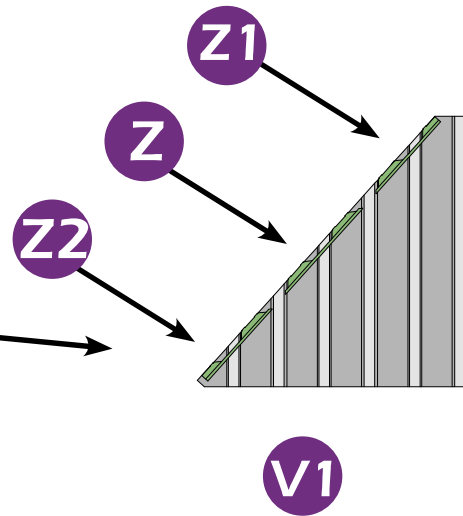
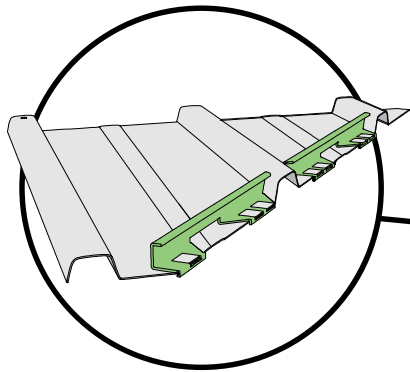

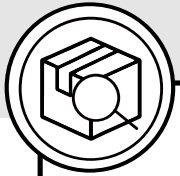

Z2 x 4

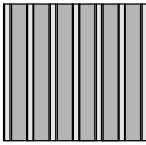

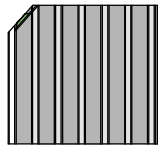
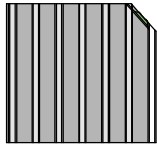
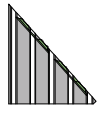
STEP 3



V × 4  **V3** × 2  **V4** × 2  **V5** × 2  **V6** × 2 

Z × 8  **Z3** × 2  **Z4** × 2 

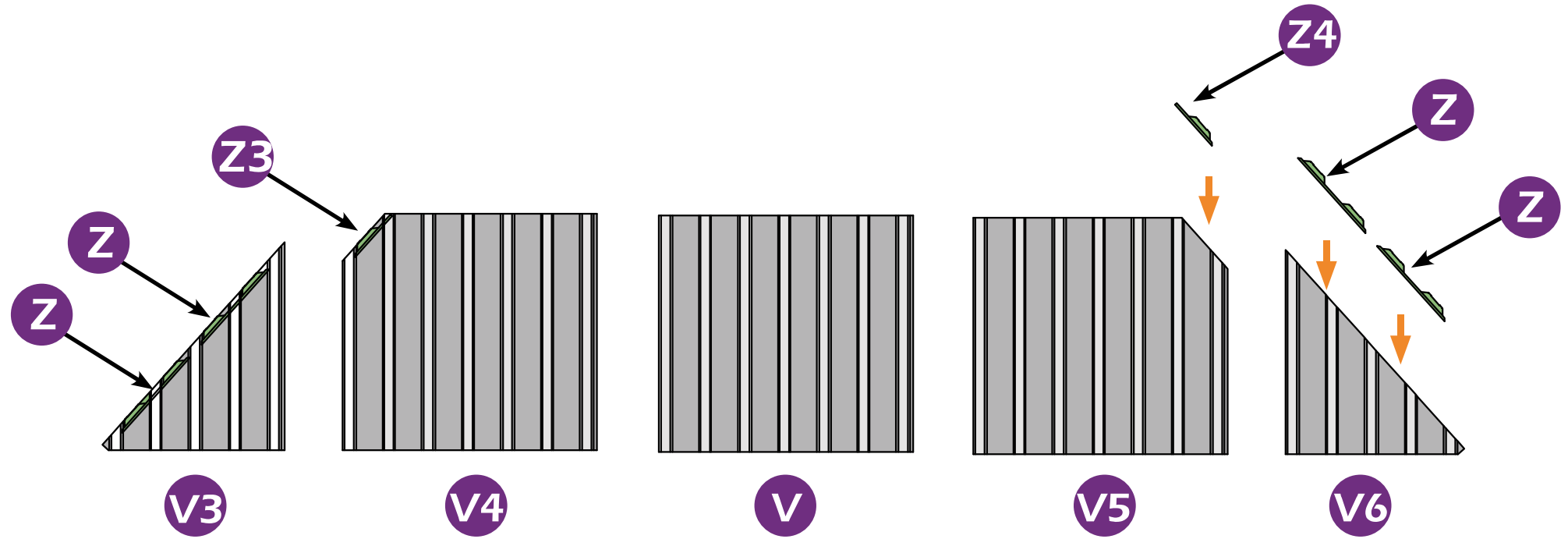

STEP 3

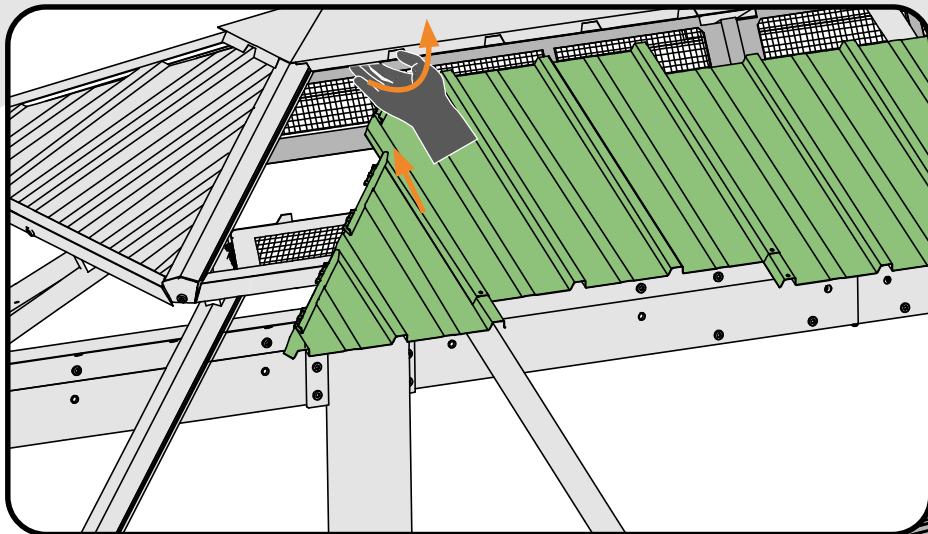

If you can't install **V4** or **V5**, push the part K up and try to insert them again.

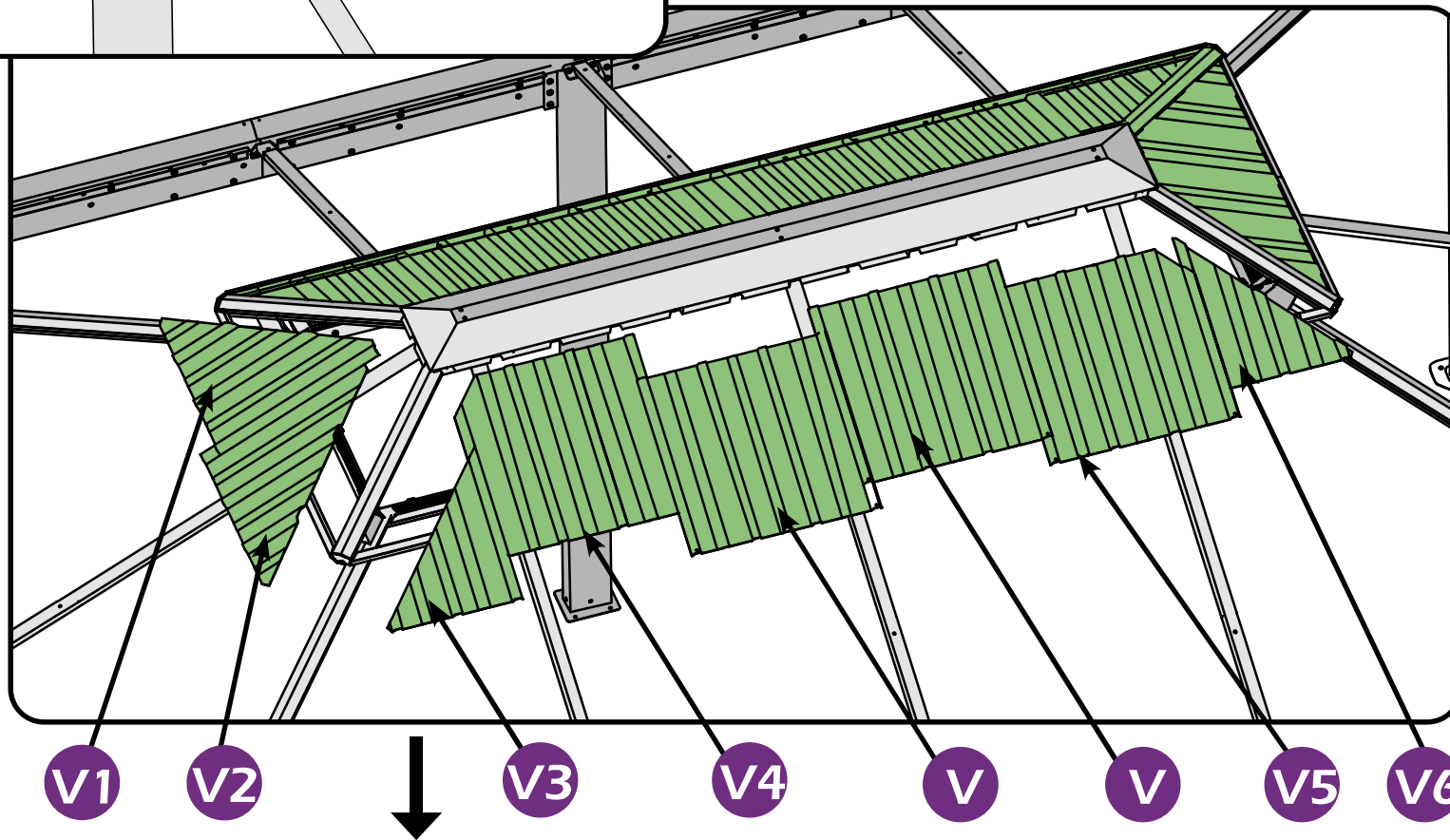

STEP 3

1#

Fully fasten the 1# bolts in K & K1.

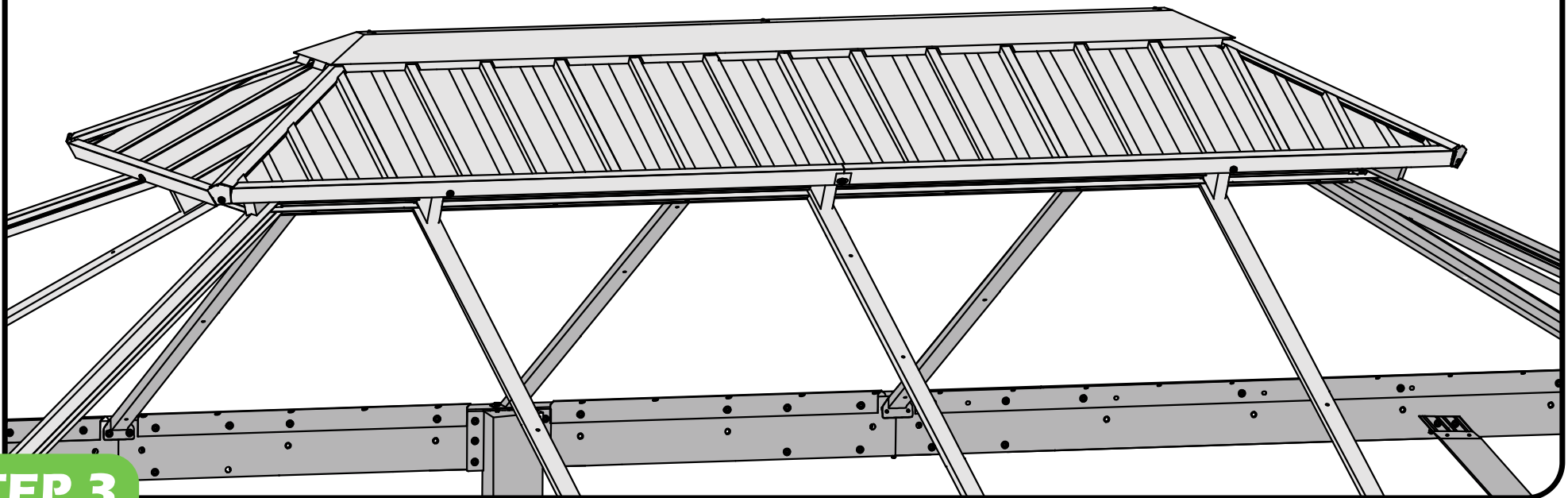
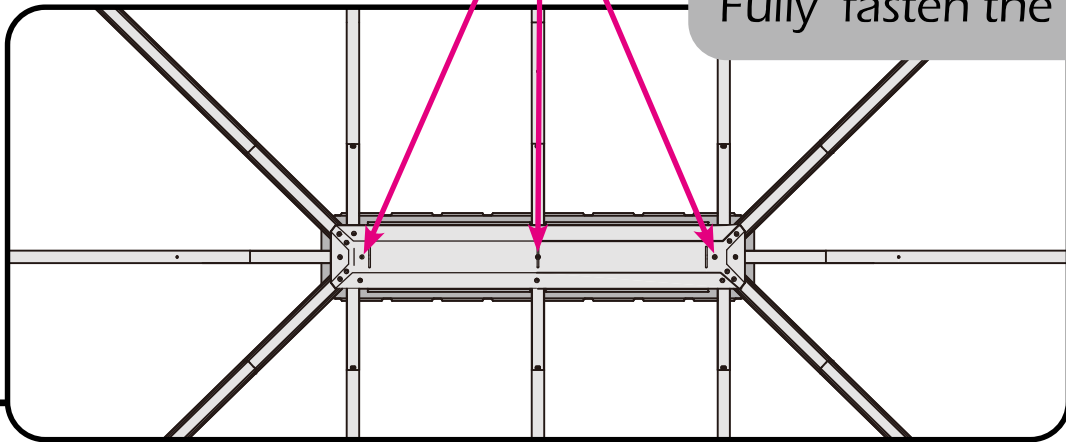

STEP 3

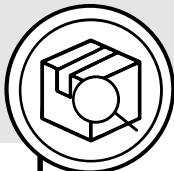

- U1 × 2
- U2 × 2
- U3 × 2
- U4 × 2
- U5 × 4
- U6 × 6
- U7 × 2
- 1# × 32

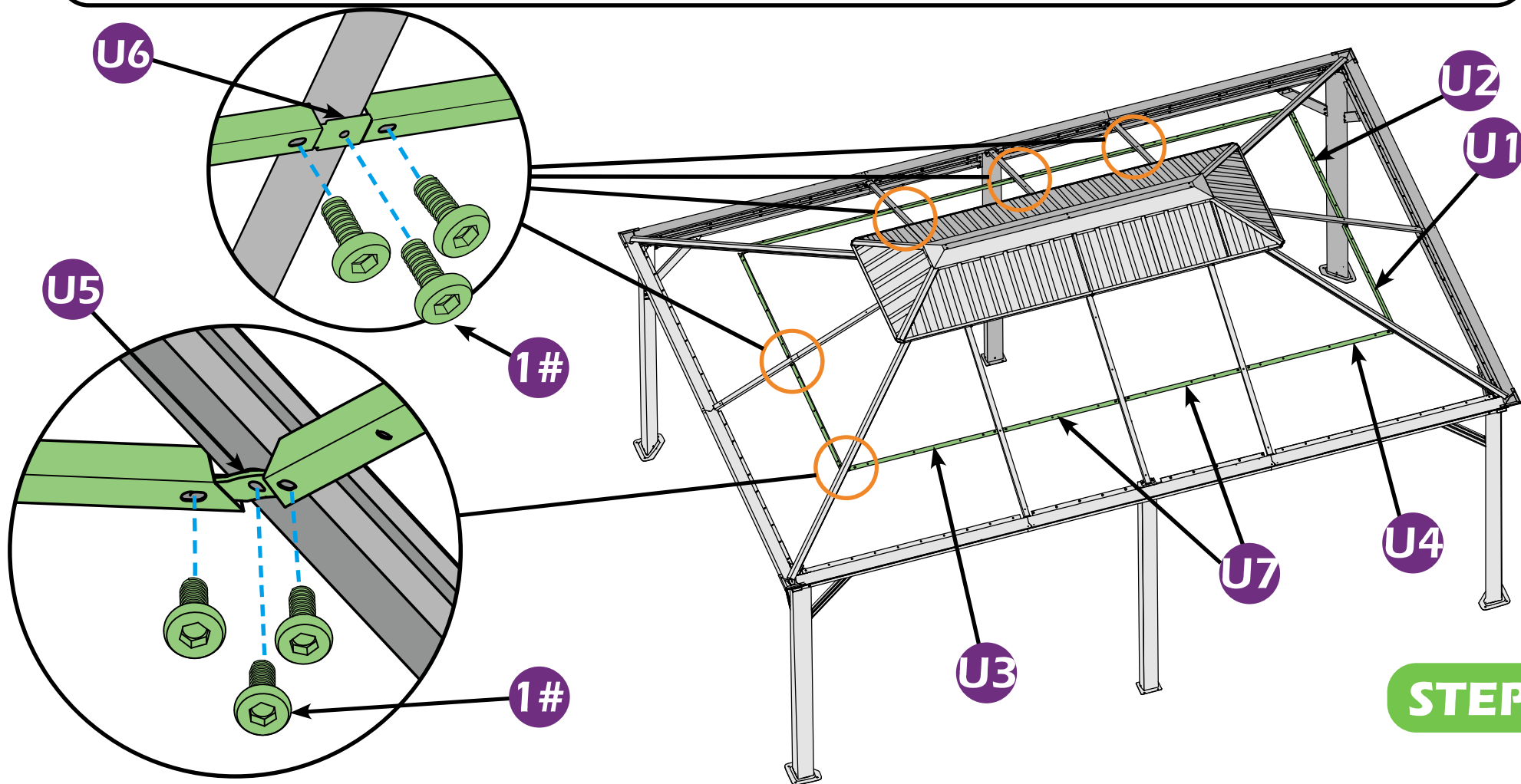

STEP 3

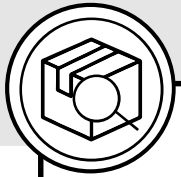

W1 x 2



W2 x 2

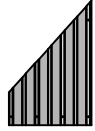

W3 x 2



W4 x 2



Z x 32



W8 x 2



W7 x 2

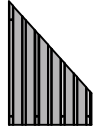

W6 x 2



W5 x 2

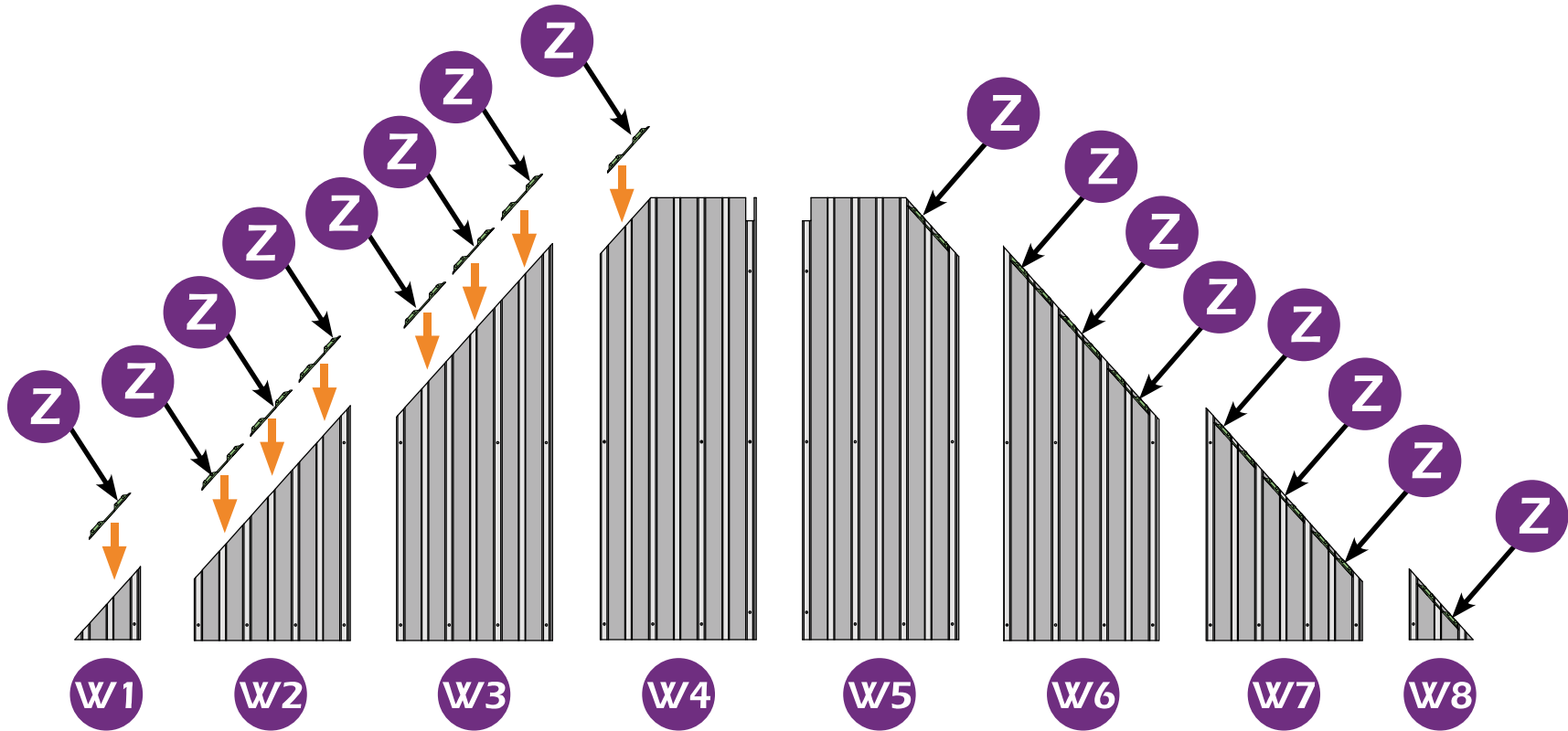

STEP 3

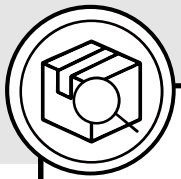

X5 × 2



X6 × 2

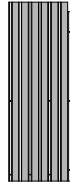

X7 × 2

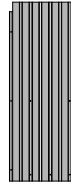

X8 × 2

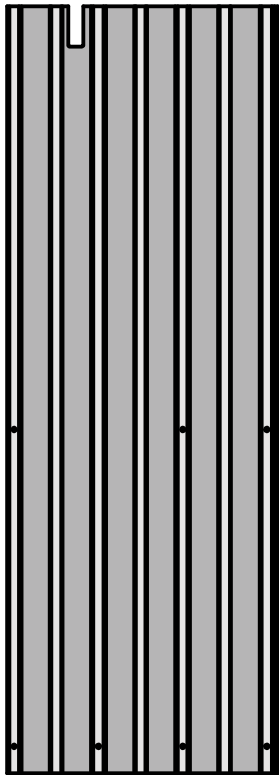
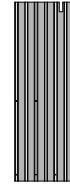

X5

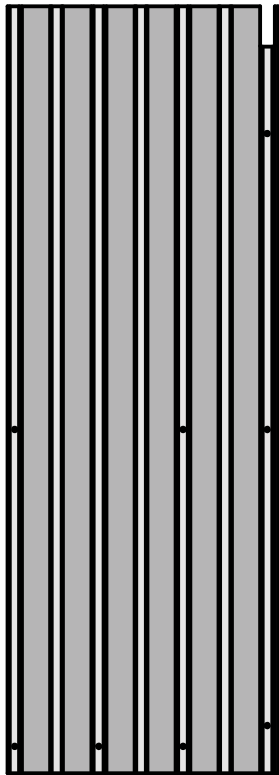

X6

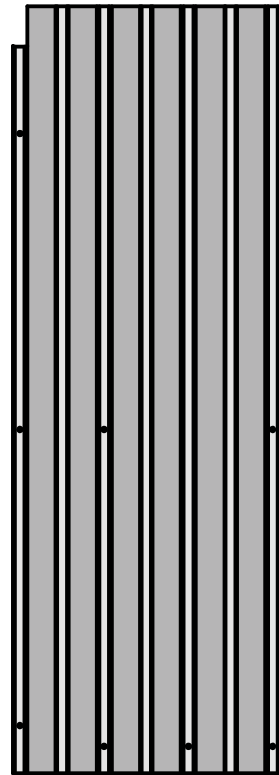

X7

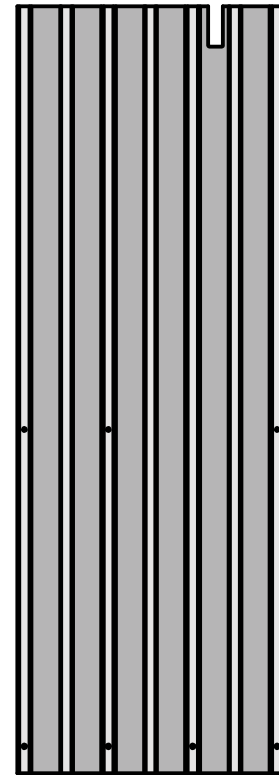

X8

STEP 3

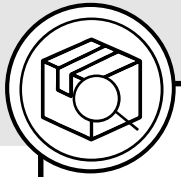

X1 × 2		X2 × 2		X3 × 2		X4 × 2		Z × 28	
X9 × 2		X10 × 2		X11 × 2		X12 × 2		Z3 × 2	
								Z4 × 2	

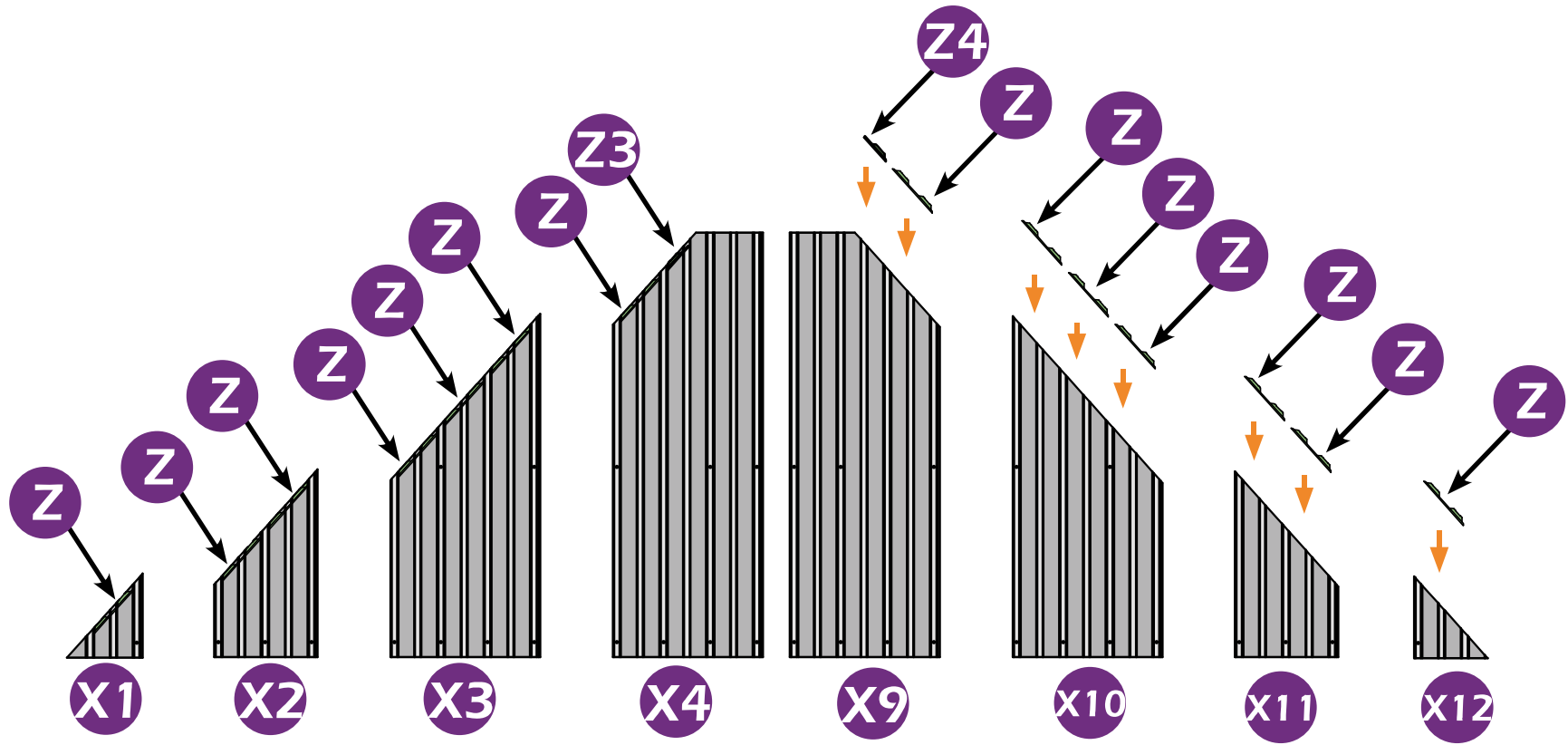

STEP 3

Install the middle panels (X6 , X7 or W4 , W5) then the small panels on the edge.

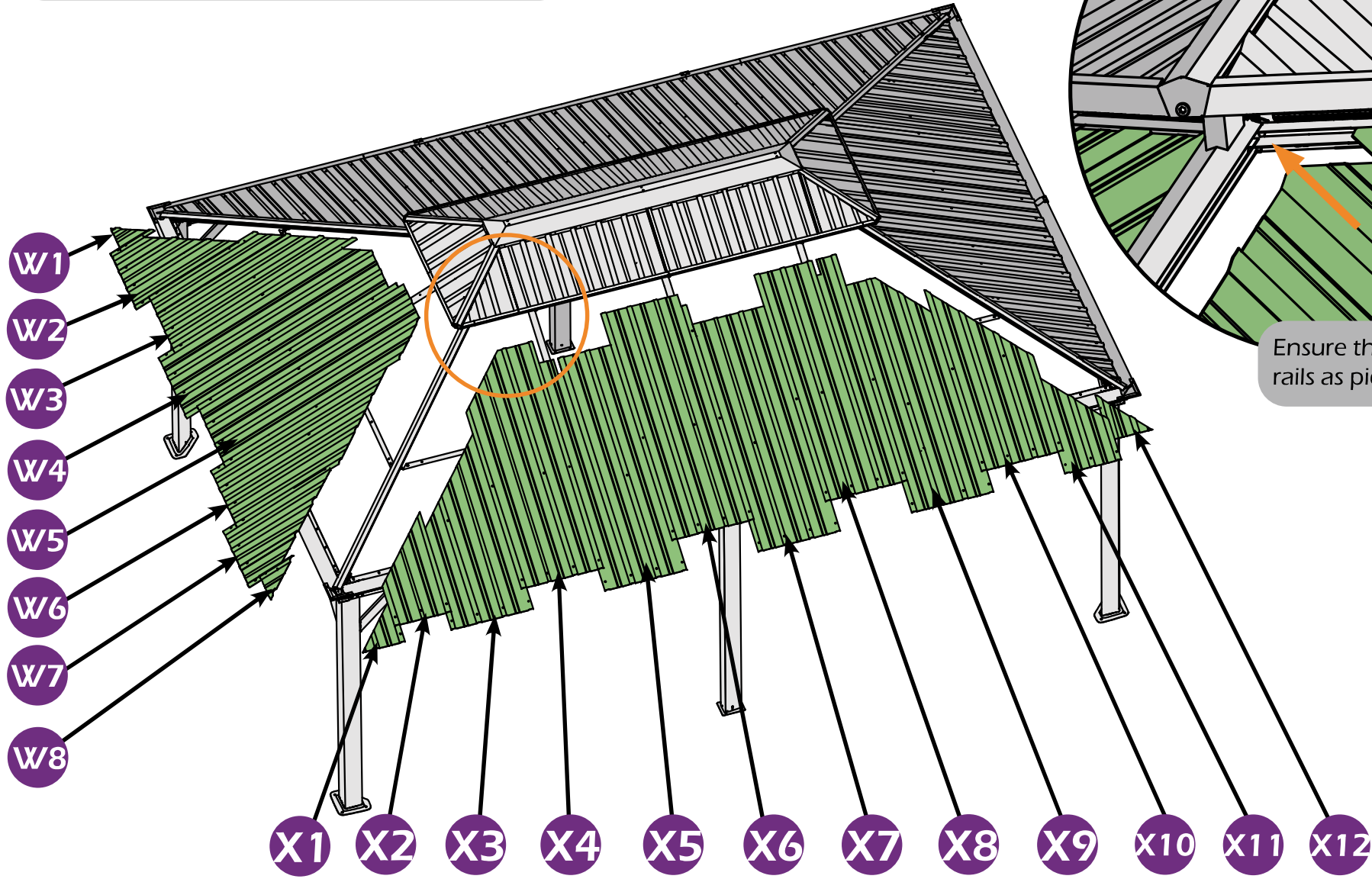

Ensure the panels stay in the rails as pictures below indicate.

STEP 3

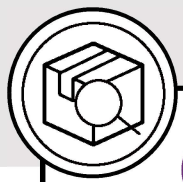

5# × 92

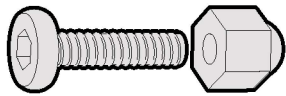

10# × 4

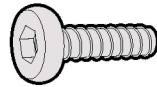

S × 96

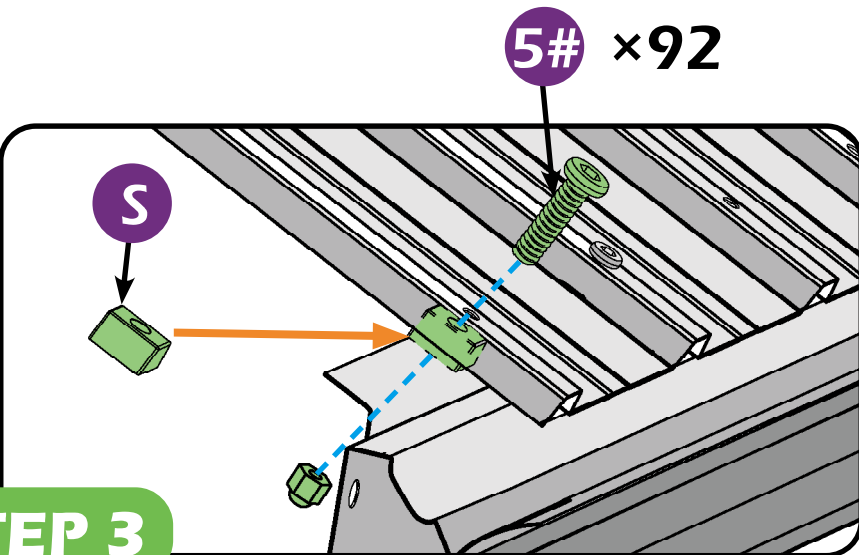
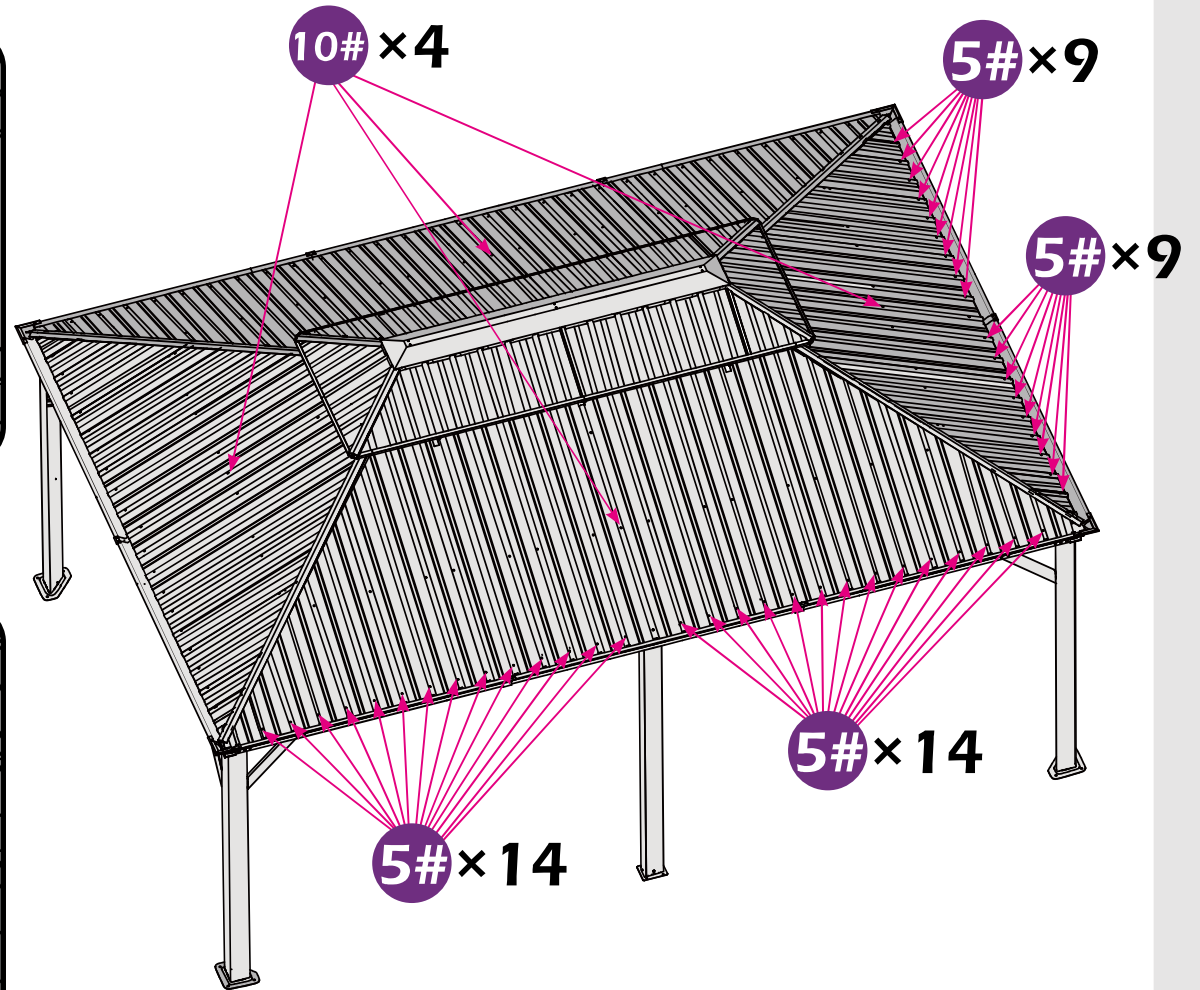
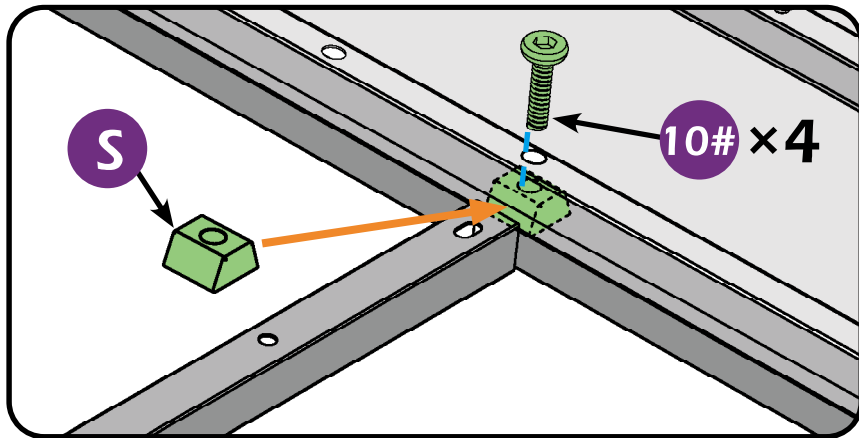
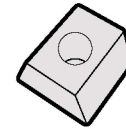

STEP 3

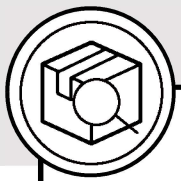

6#×8

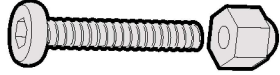

7#×44

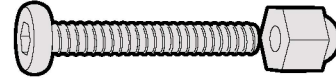

S×52

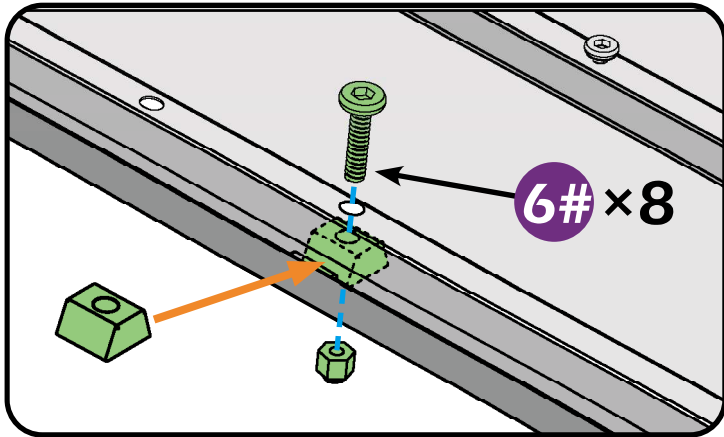
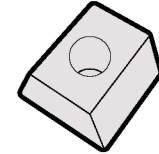

6#×8

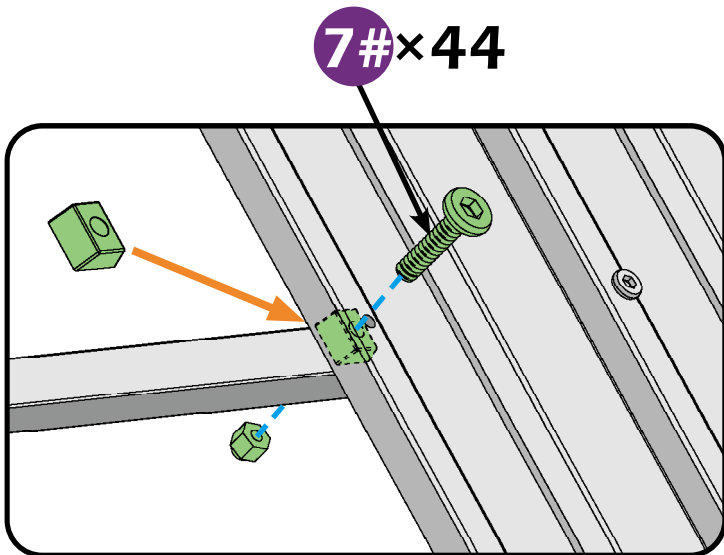

7#×44

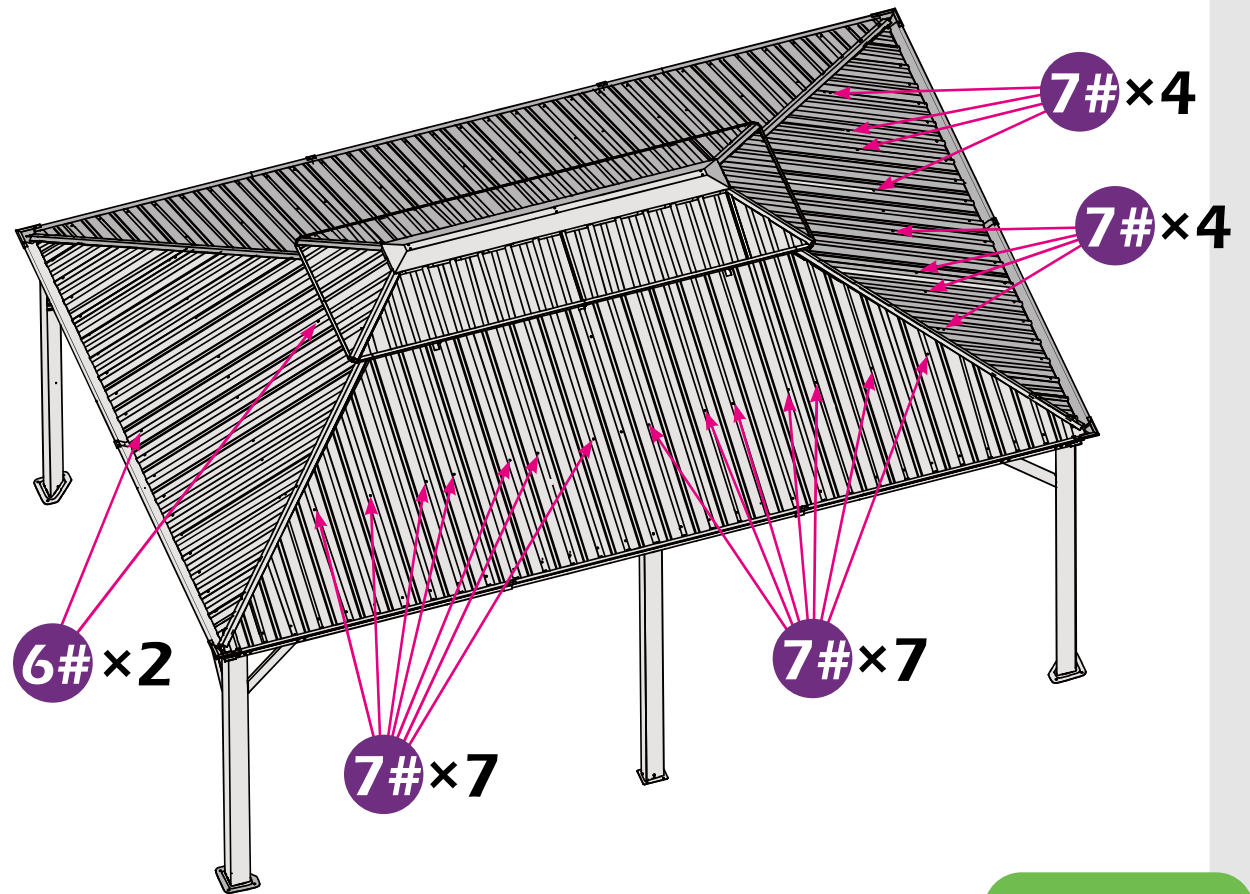

STEP 3

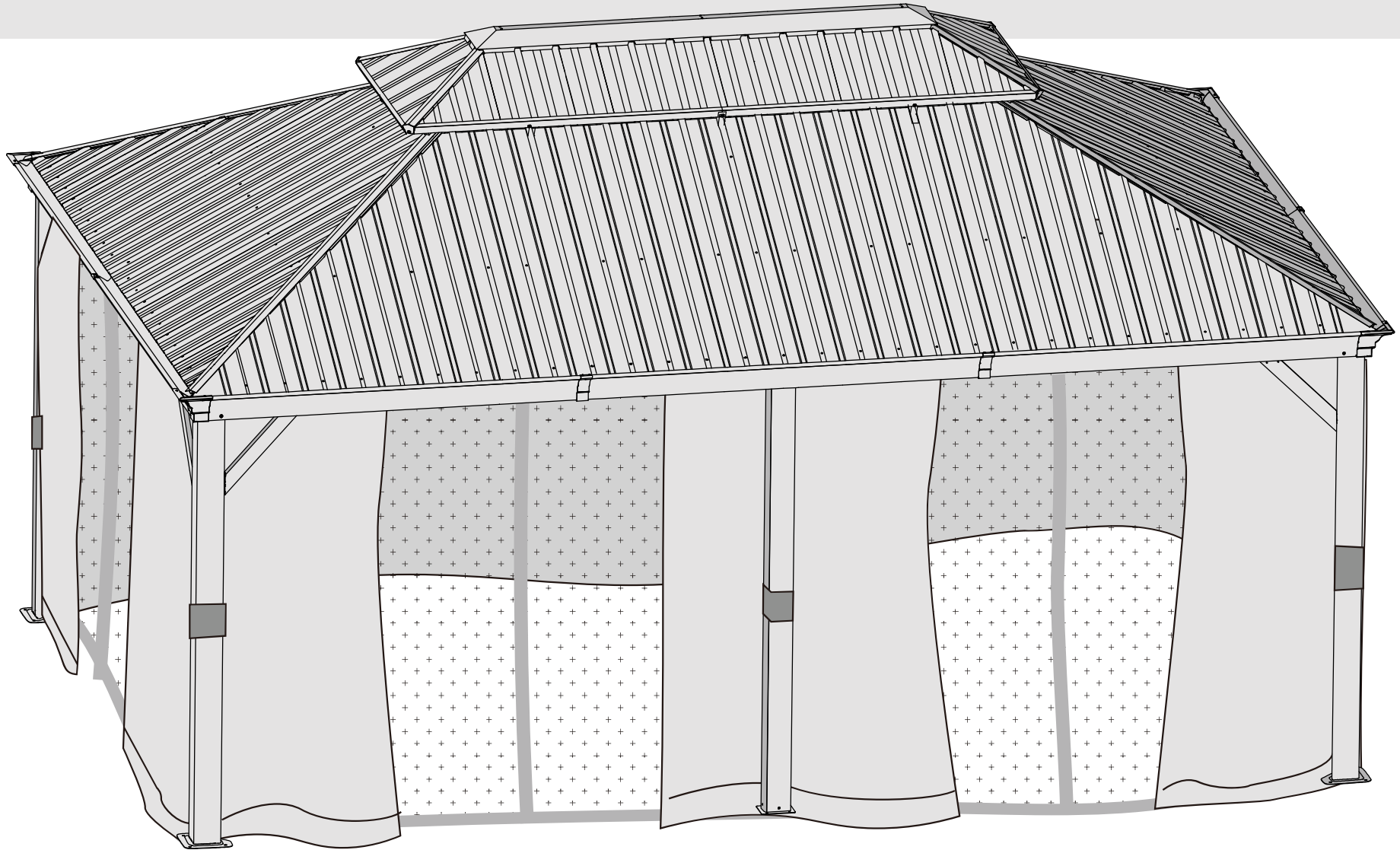

STEP 4



C1 × 2



1# × 20

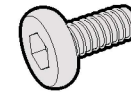

D1 × 2

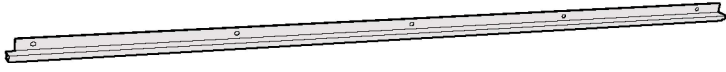

D1

C1

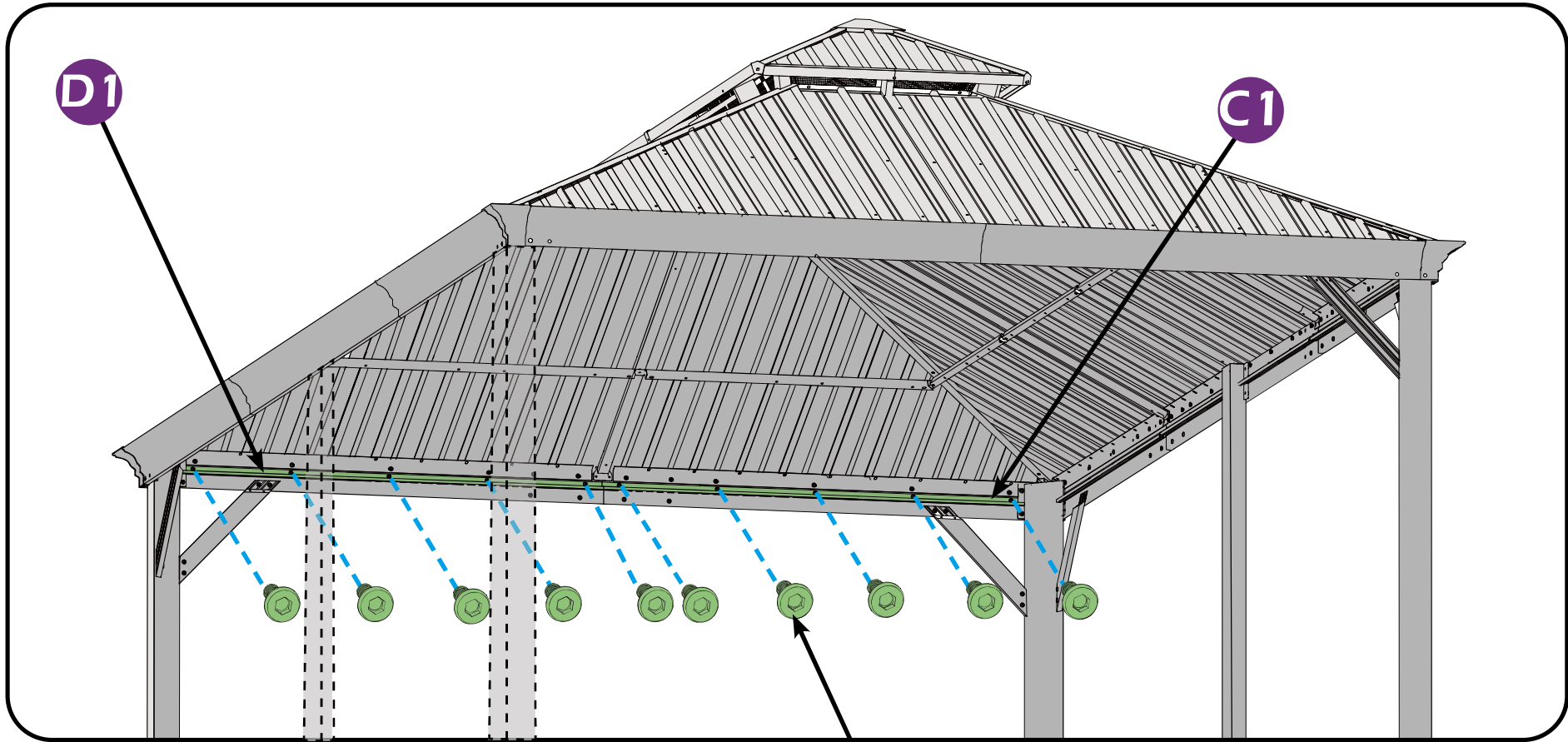

1# × 10

STEP 4



C1 × 2 

E1a × 2 

1# × 32 

D1 × 2 

E1b × 2 

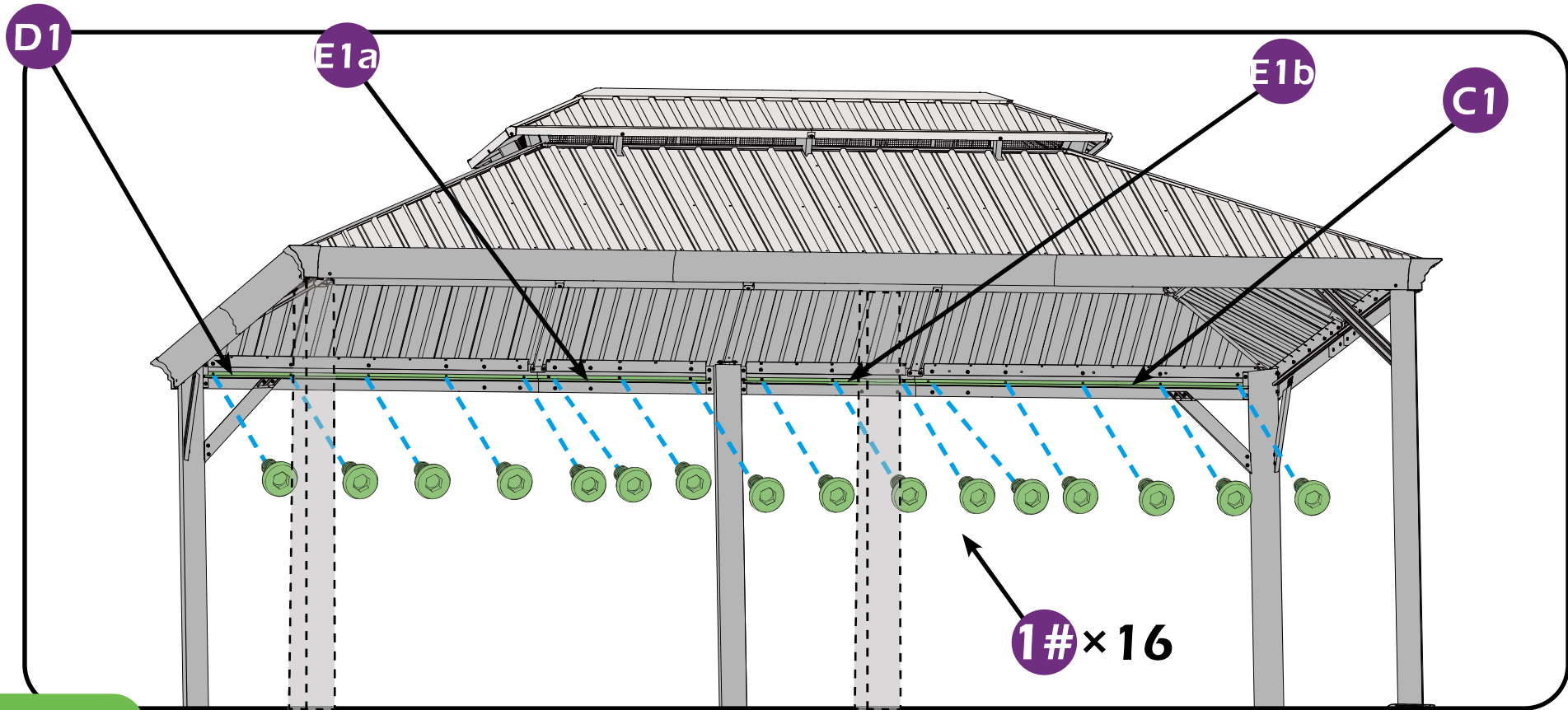

STEP 4



4#×56

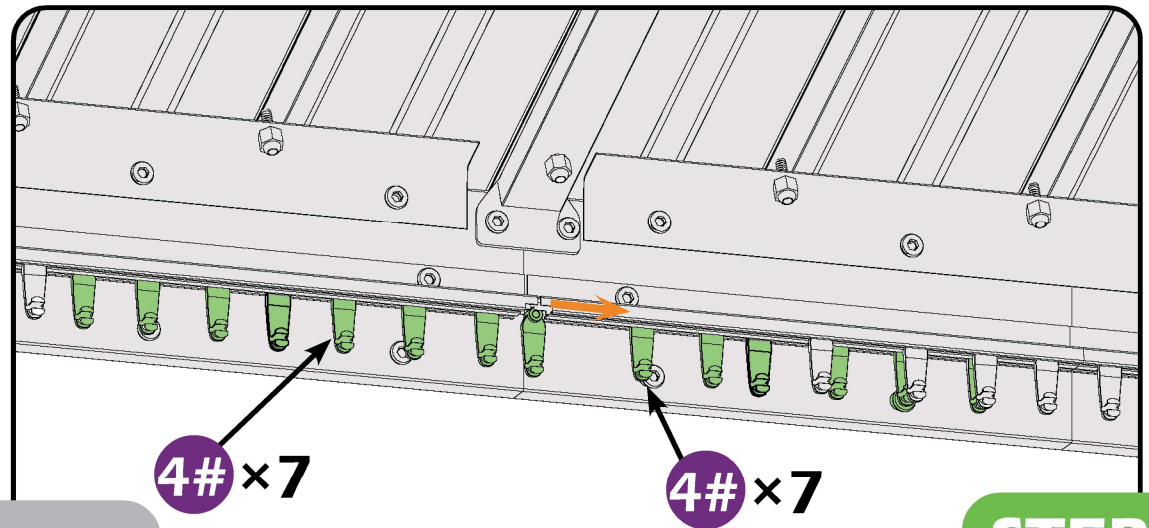
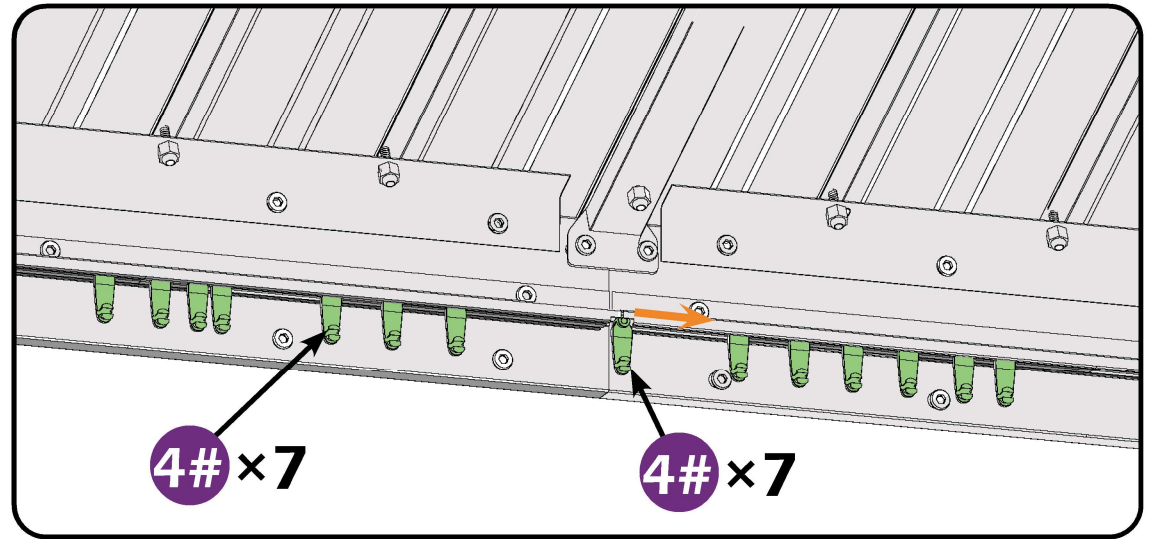
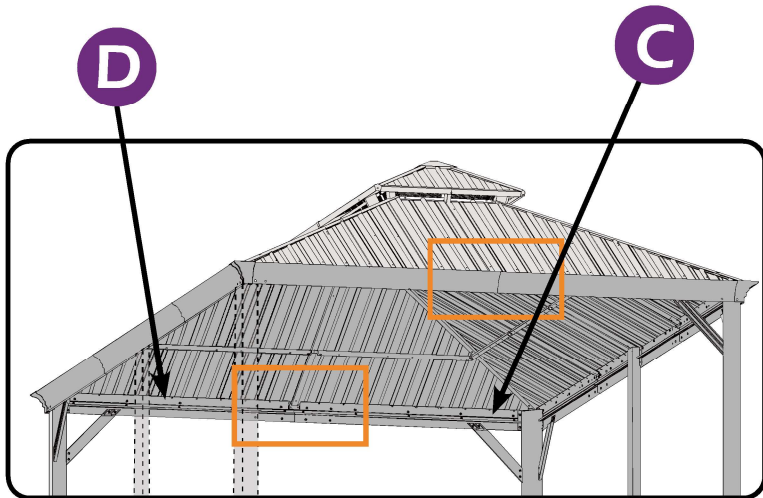
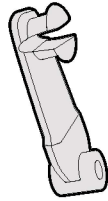

Here are two rails for curtains and netting.

STEP 4



4#×44

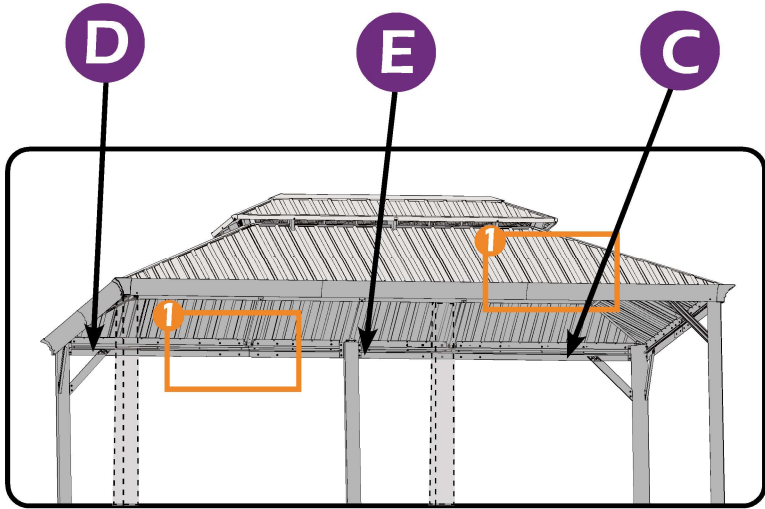
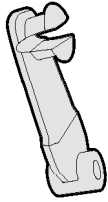

1

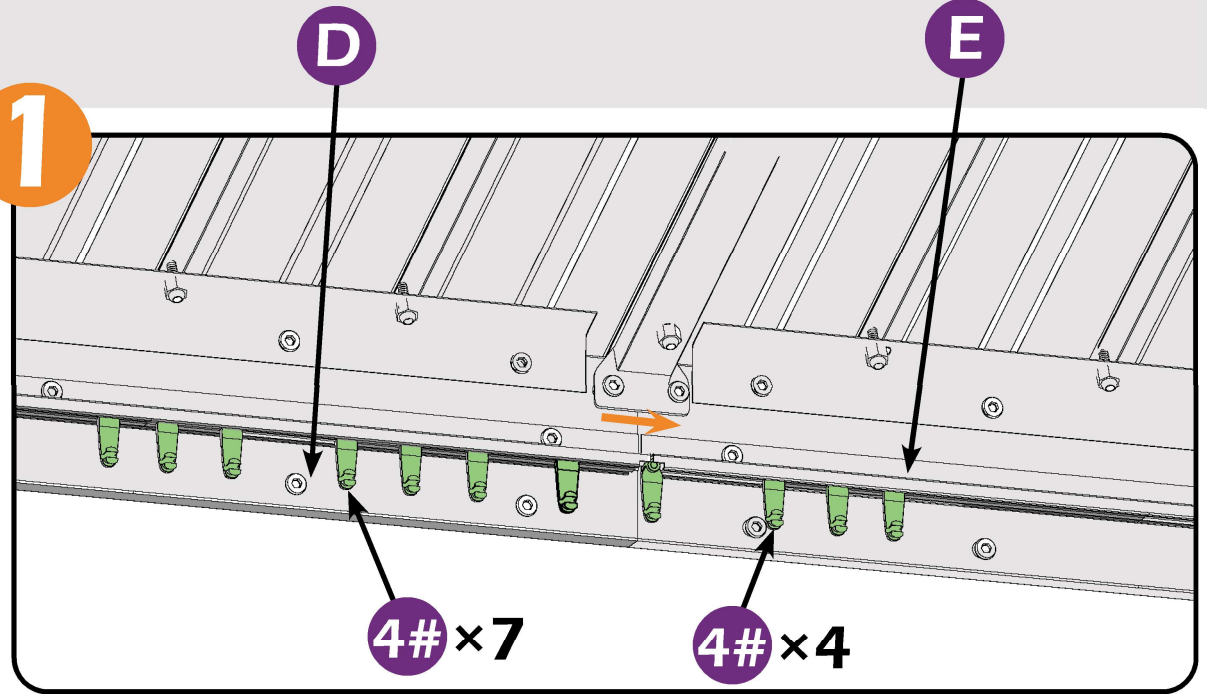

1

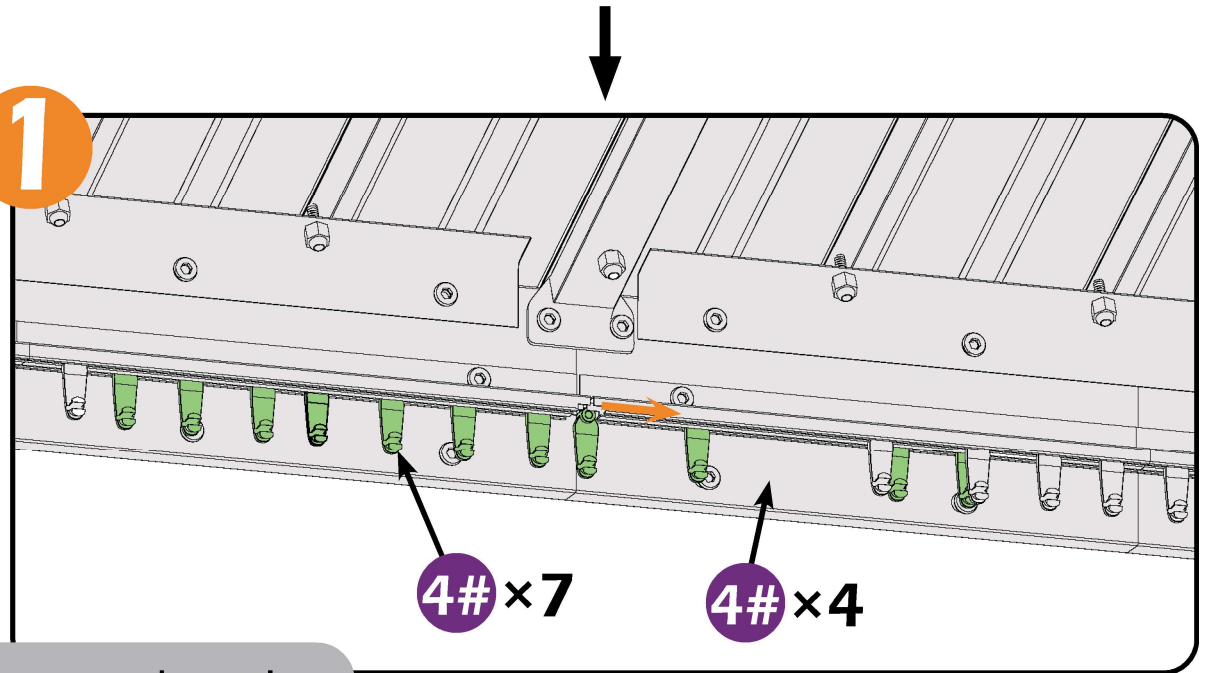

STEP 4

Here are two rails for curtains and netting.



4# x 44

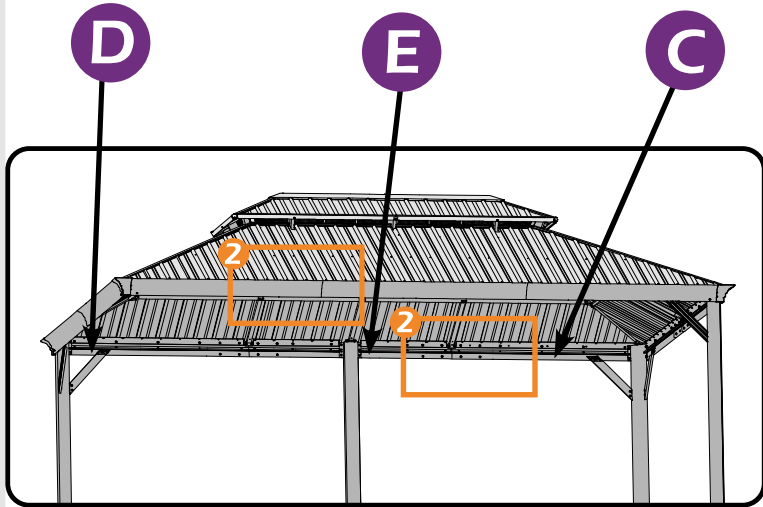
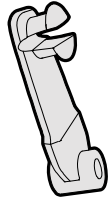

2

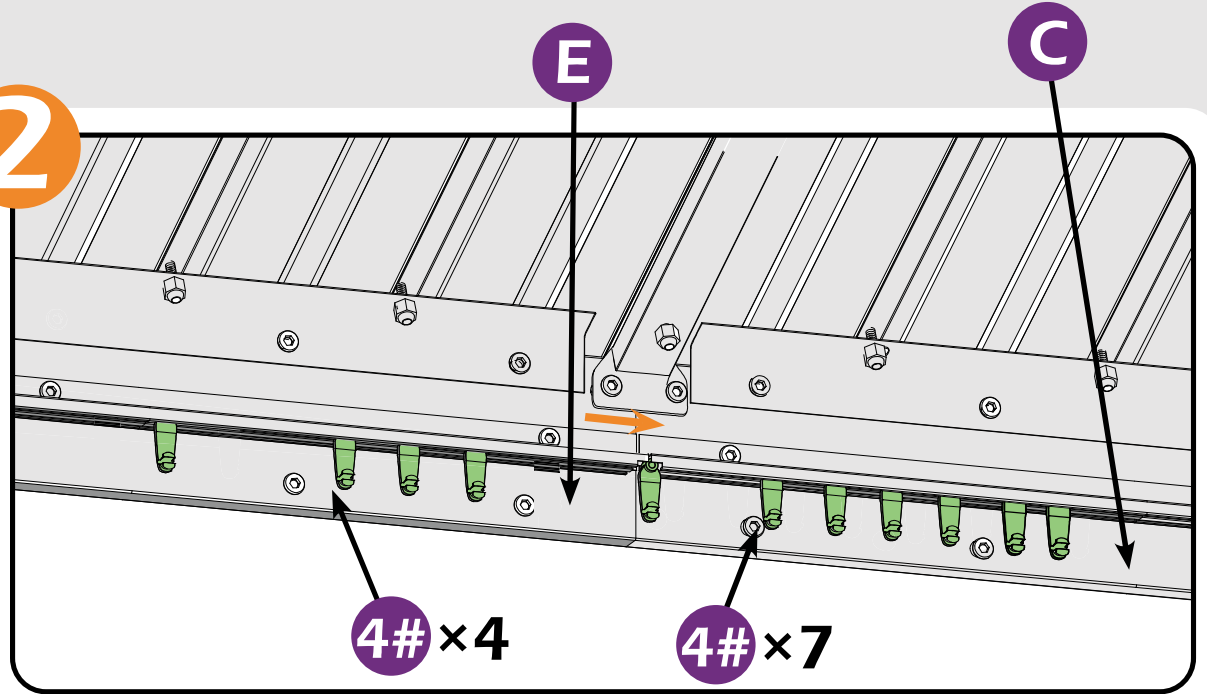

2

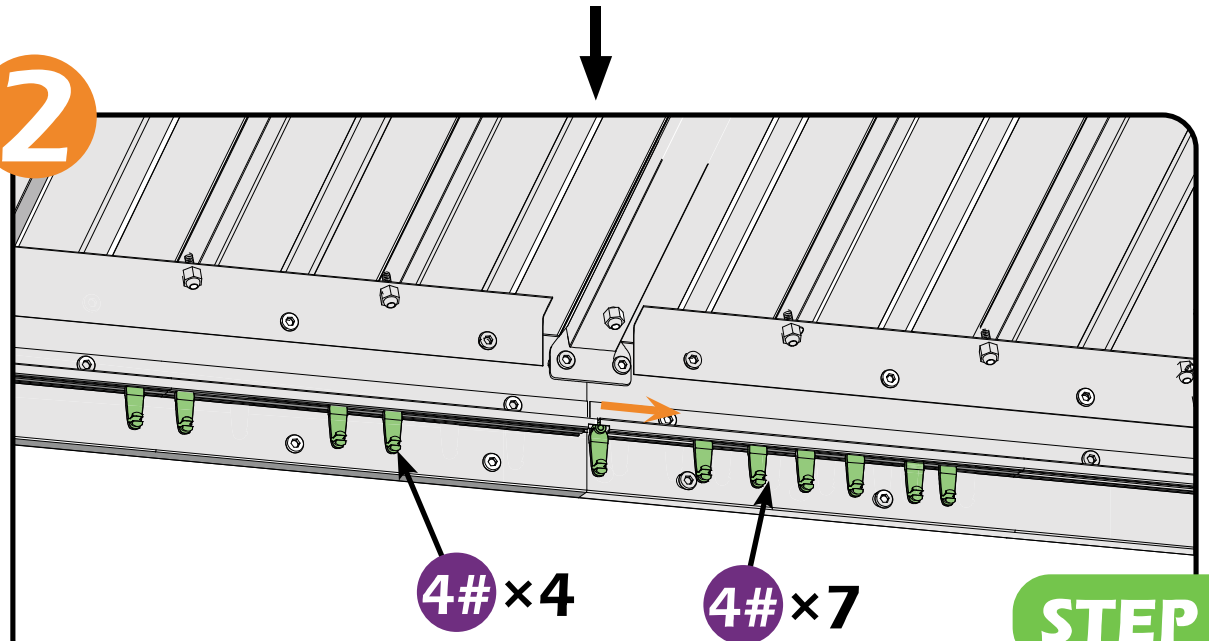

STEP 4

Here are two rails for curtains and netting.

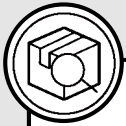

H×6

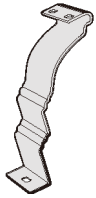

H1×6

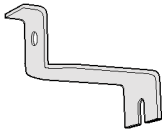

8#×6

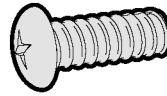

9#×12

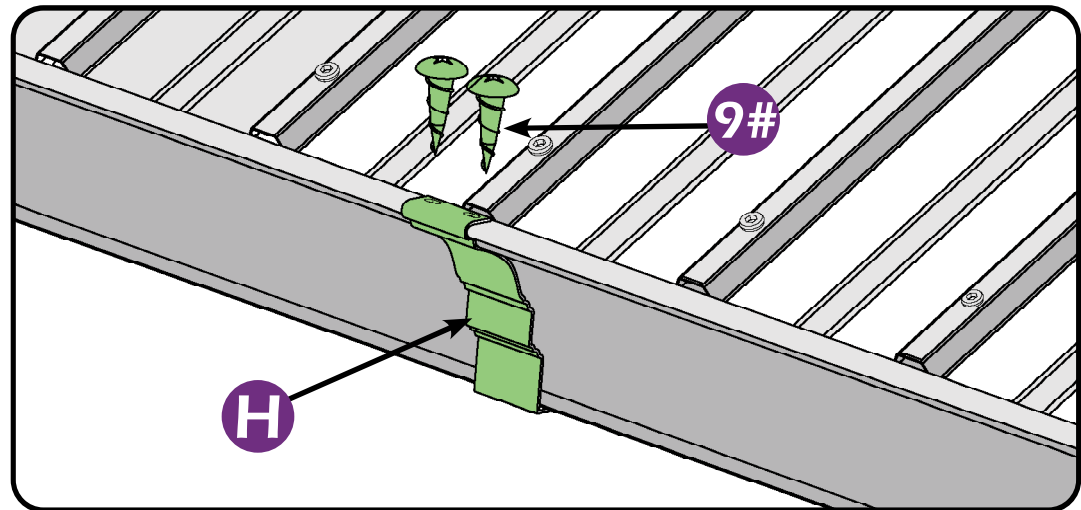
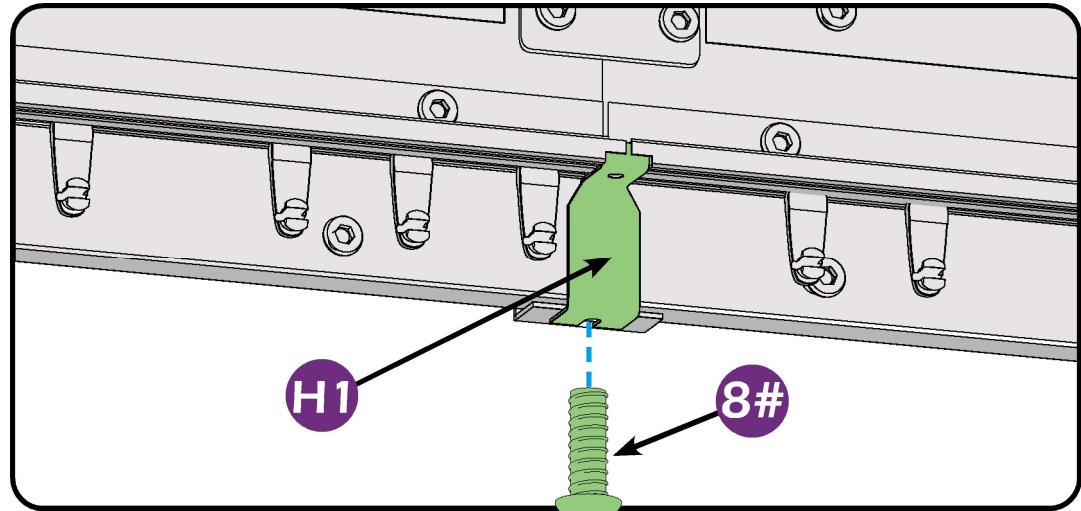
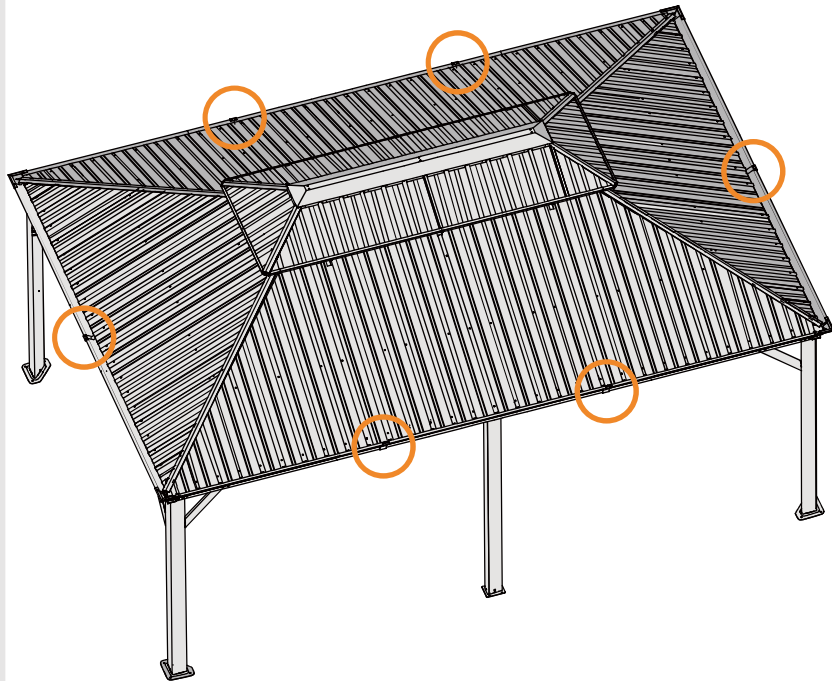
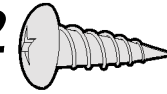

STEP 4



H2 x 1

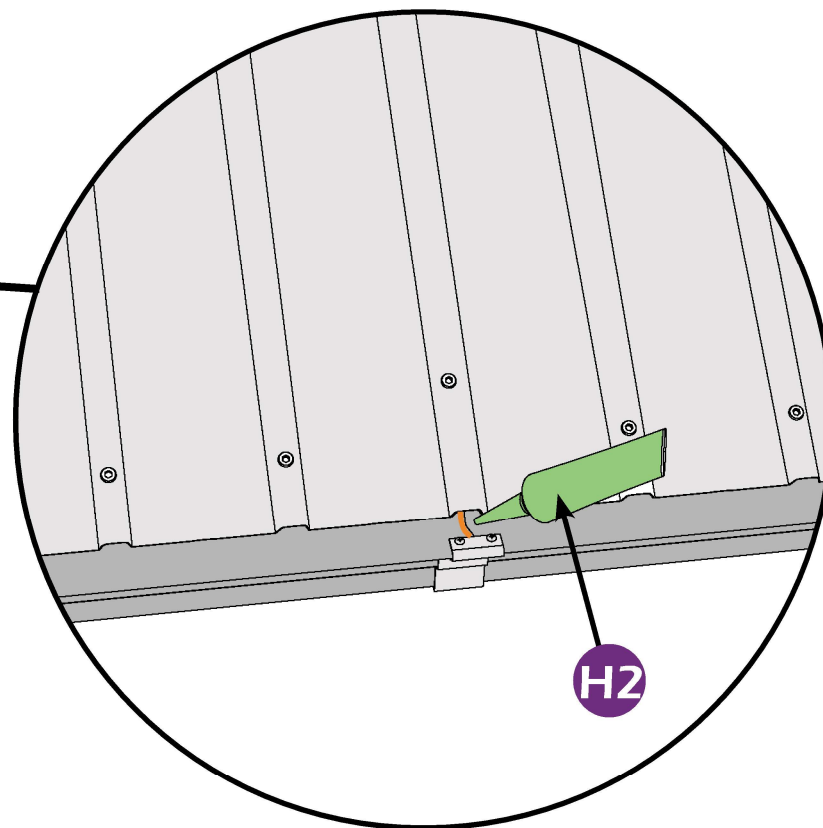
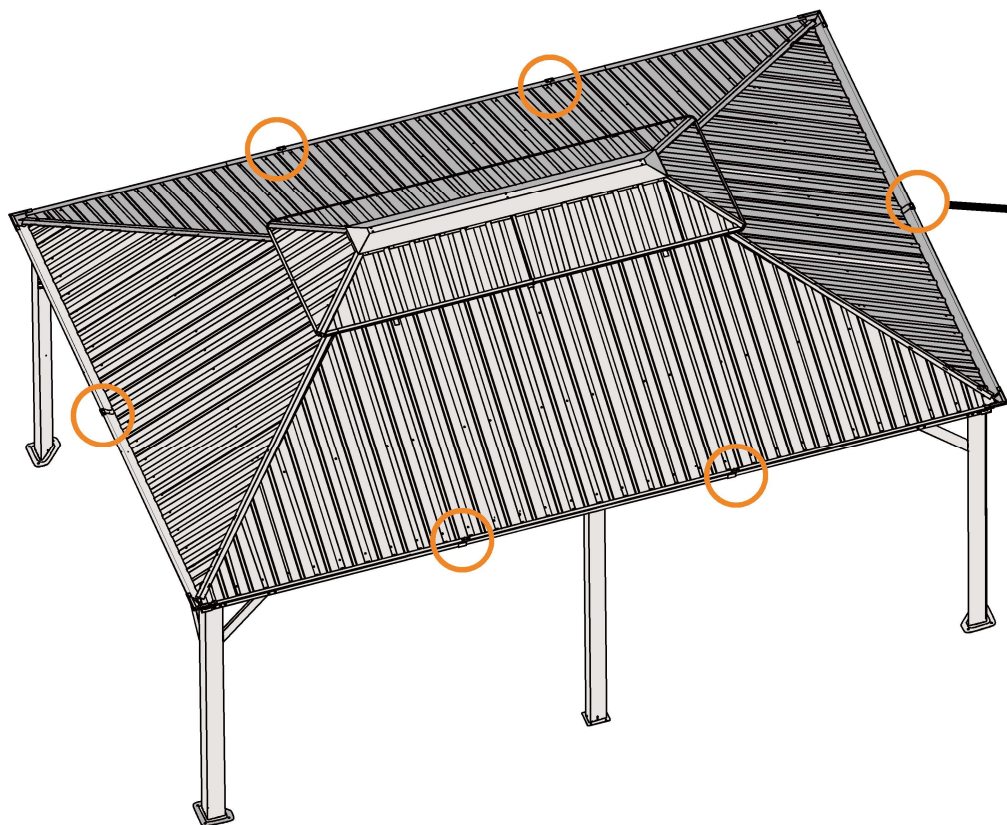
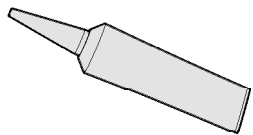

STEP 4



Y × 4

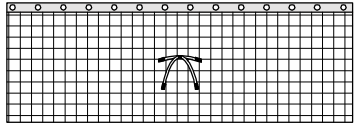

Ya × 4

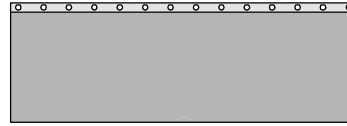

Y1 × 2

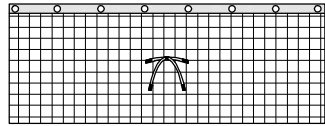

Y1a × 2

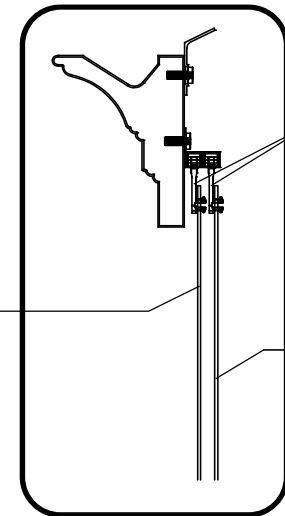
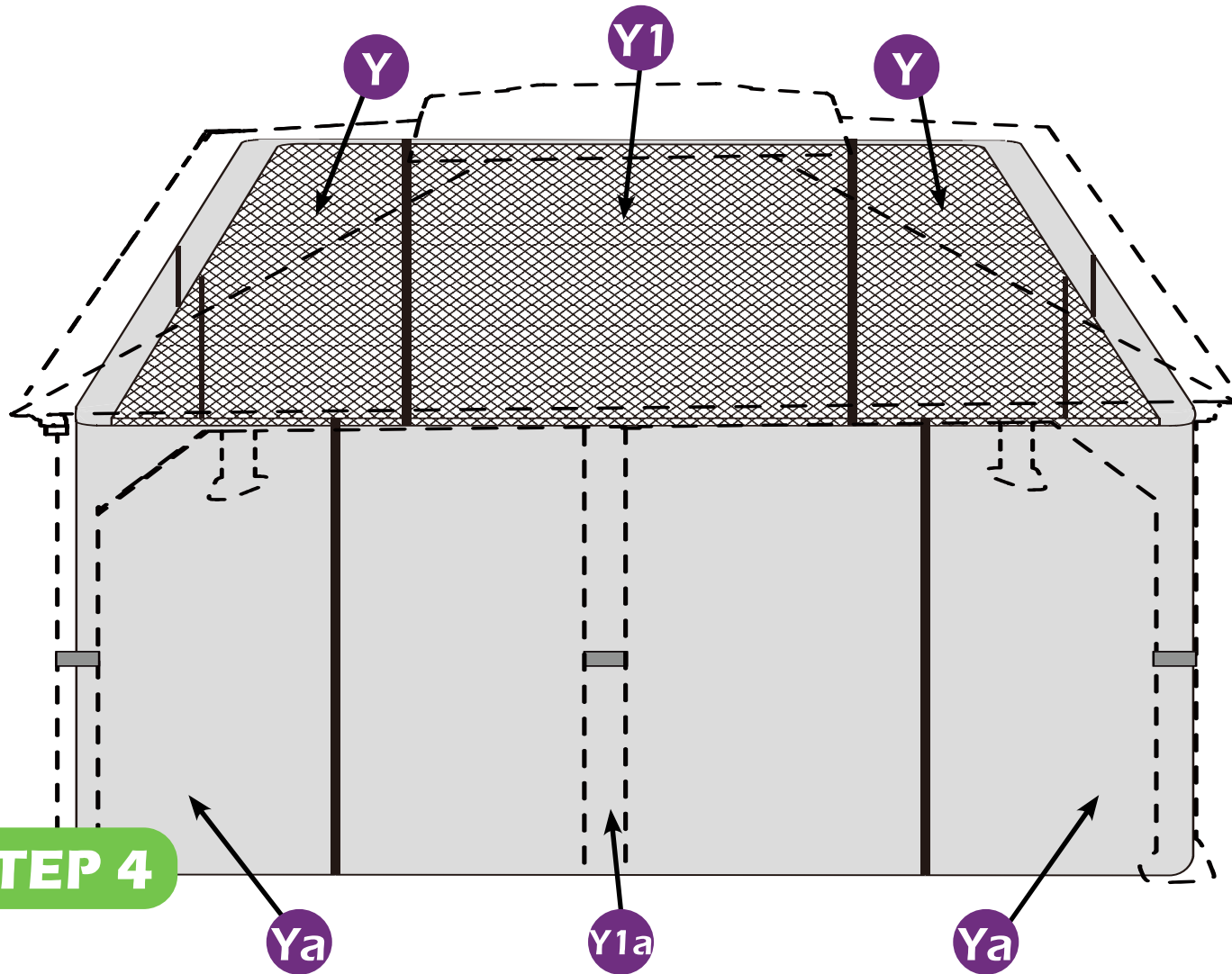
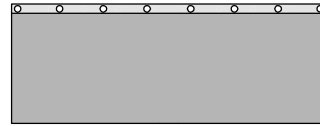

Ya & Y1a

4#

Y & Y1

Pictures below indicate the number of holes on the curtains/netting, each hole is match to one hook.

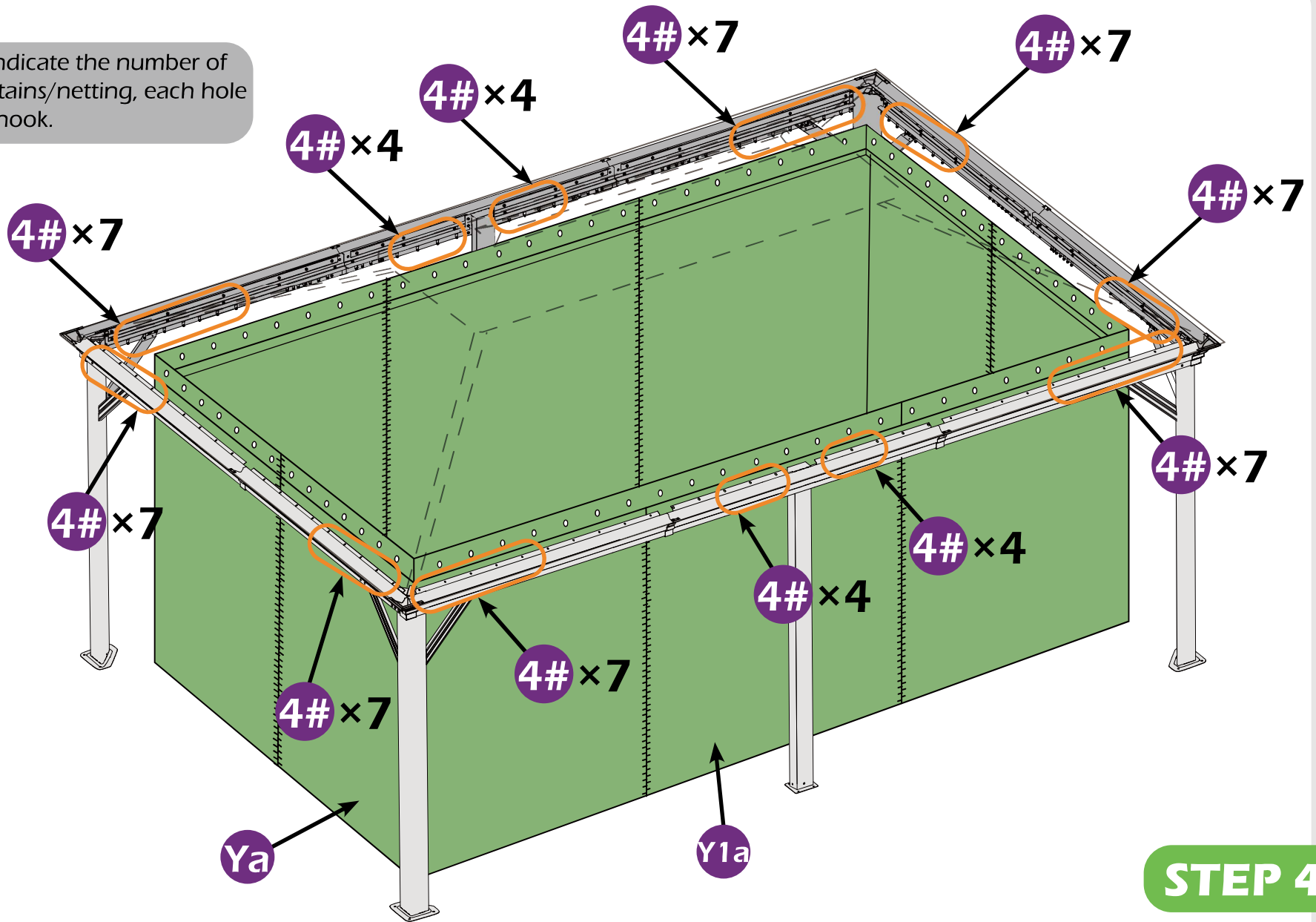

STEP 4

Pictures below indicate the number of holes on the curtains/netting, each hole is match to one hook.

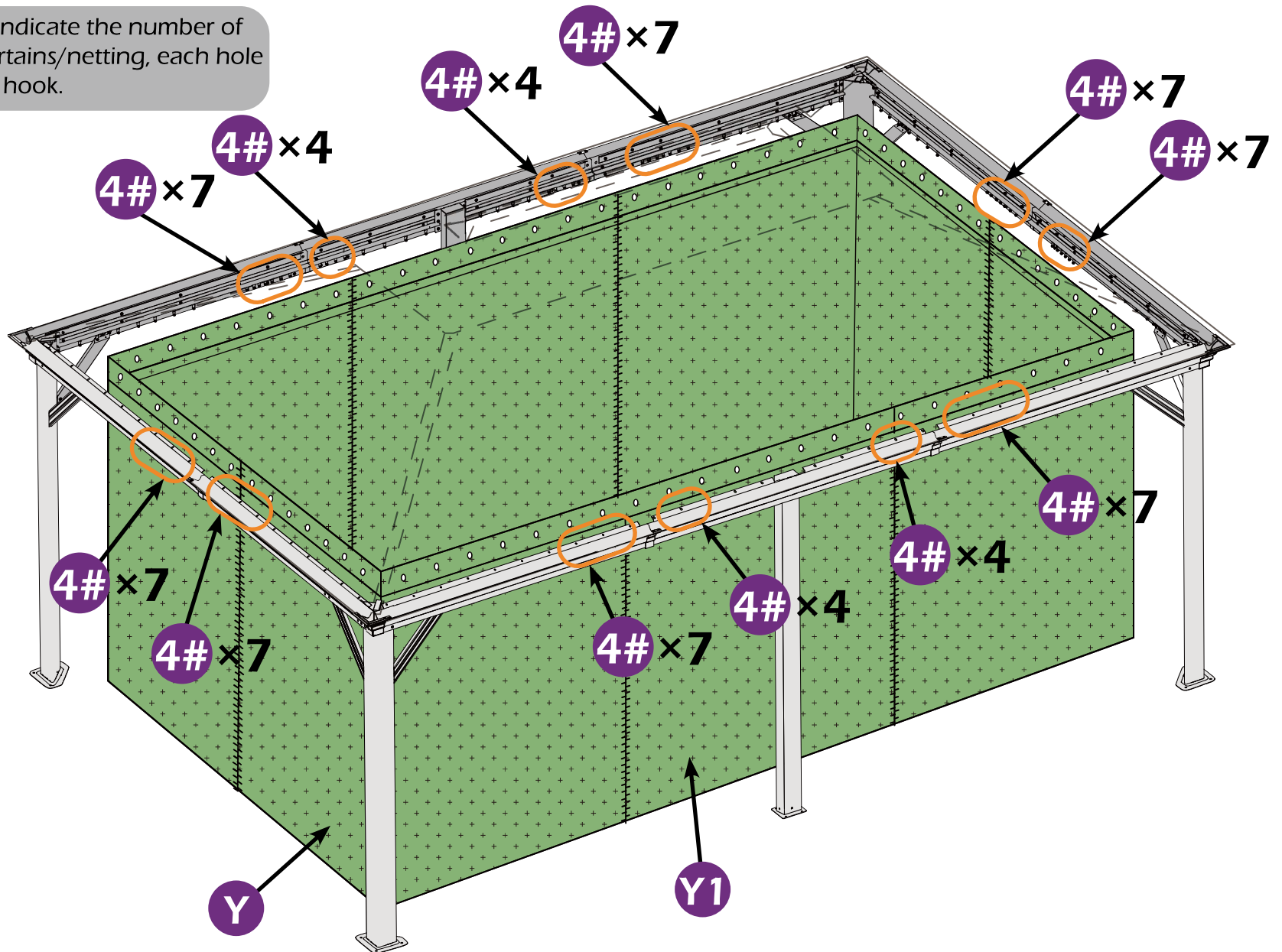

STEP 4

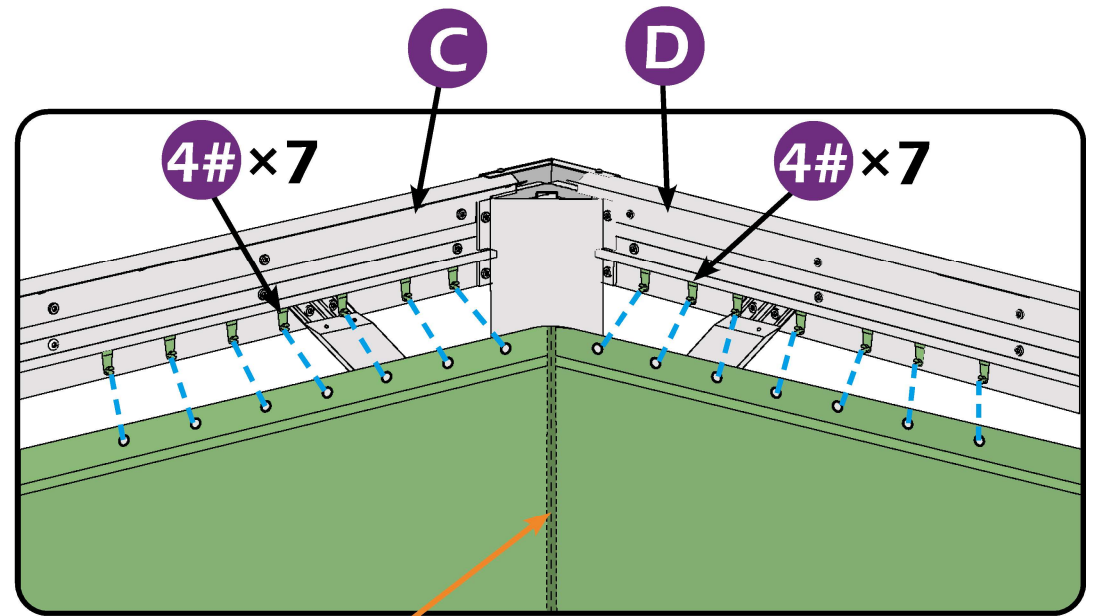
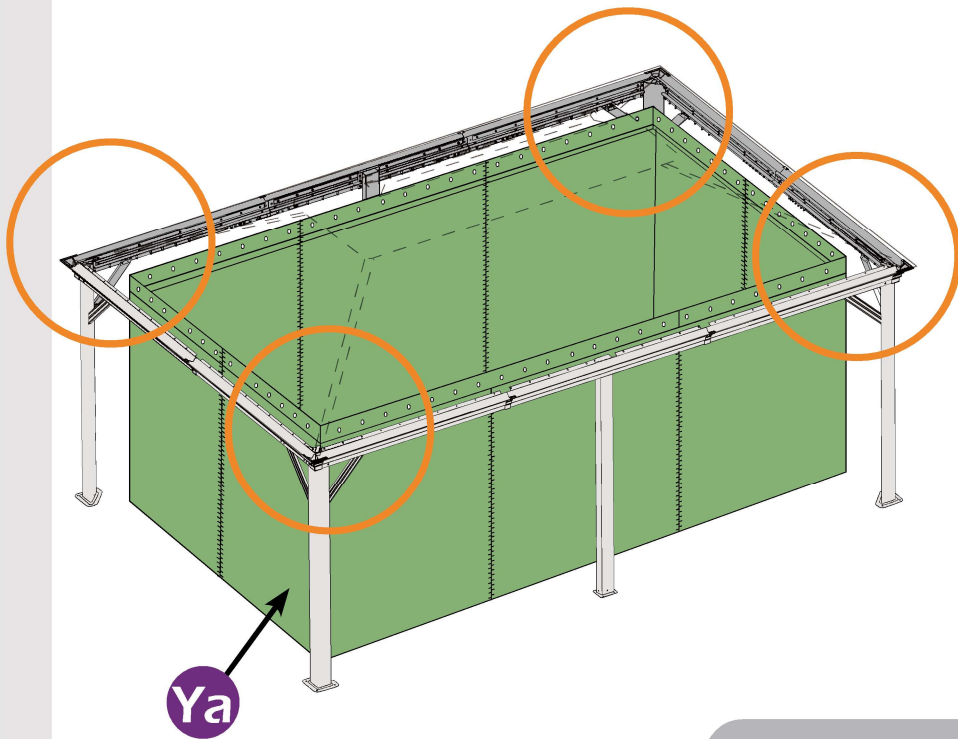

Ensure the suture line close to the pole

STEP 4

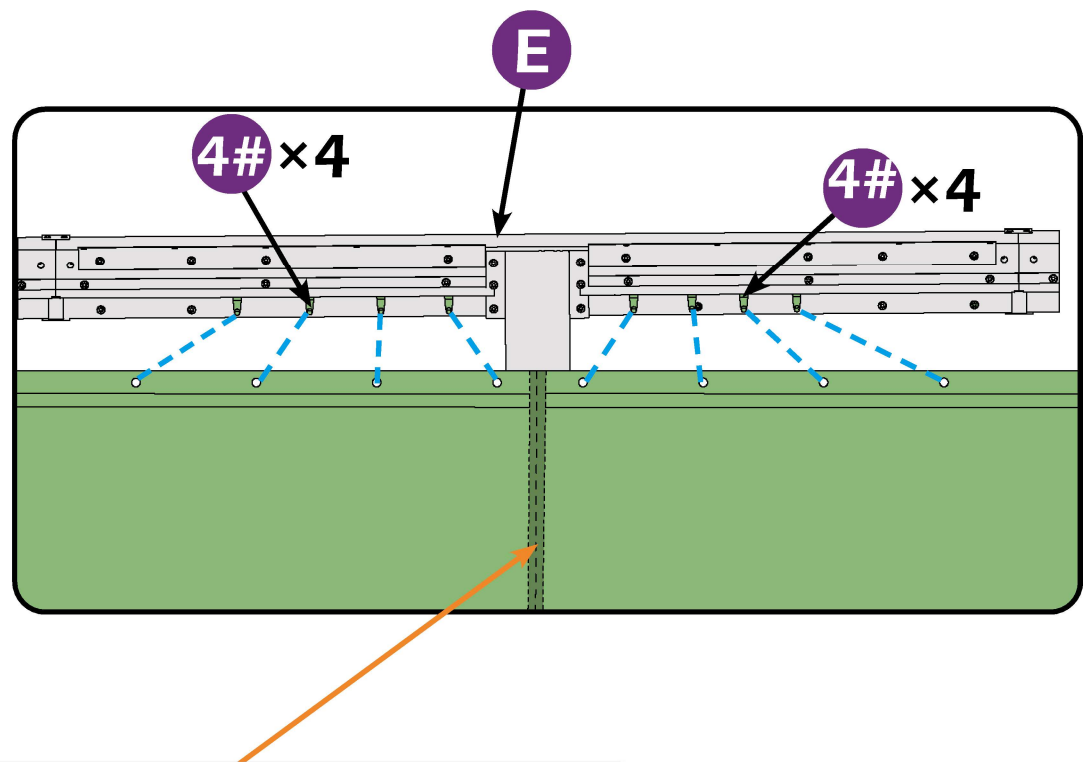
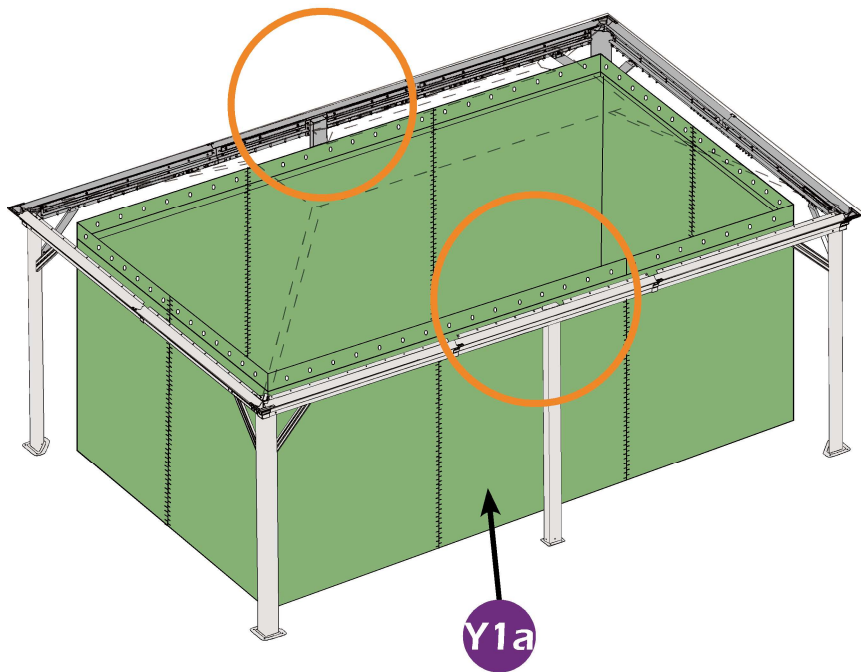

Ensure the suture line close to the pole

STEP 4

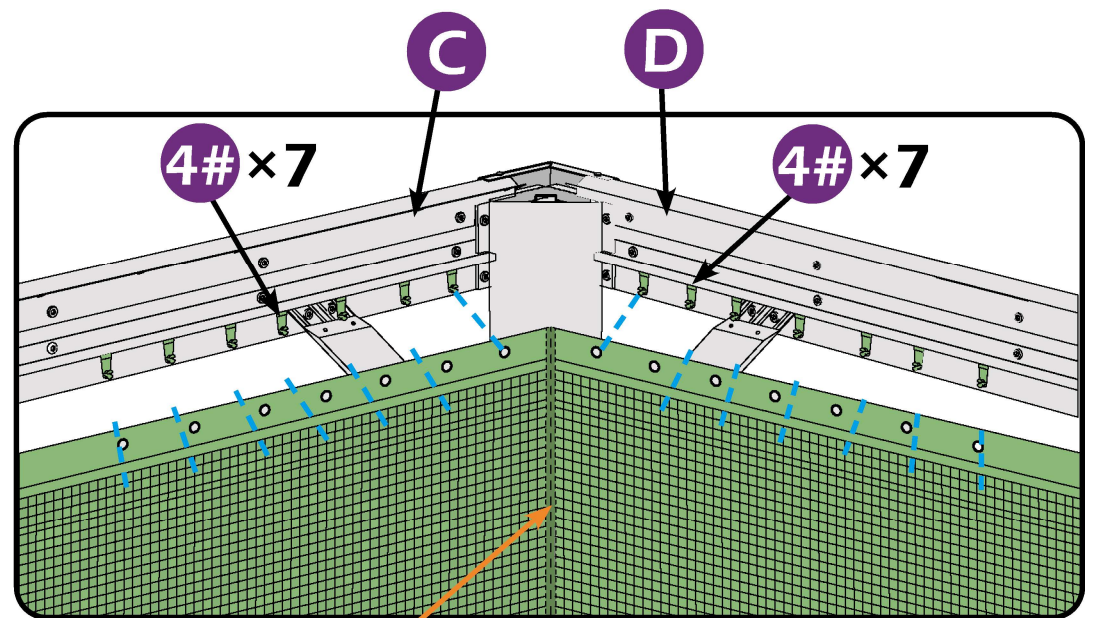
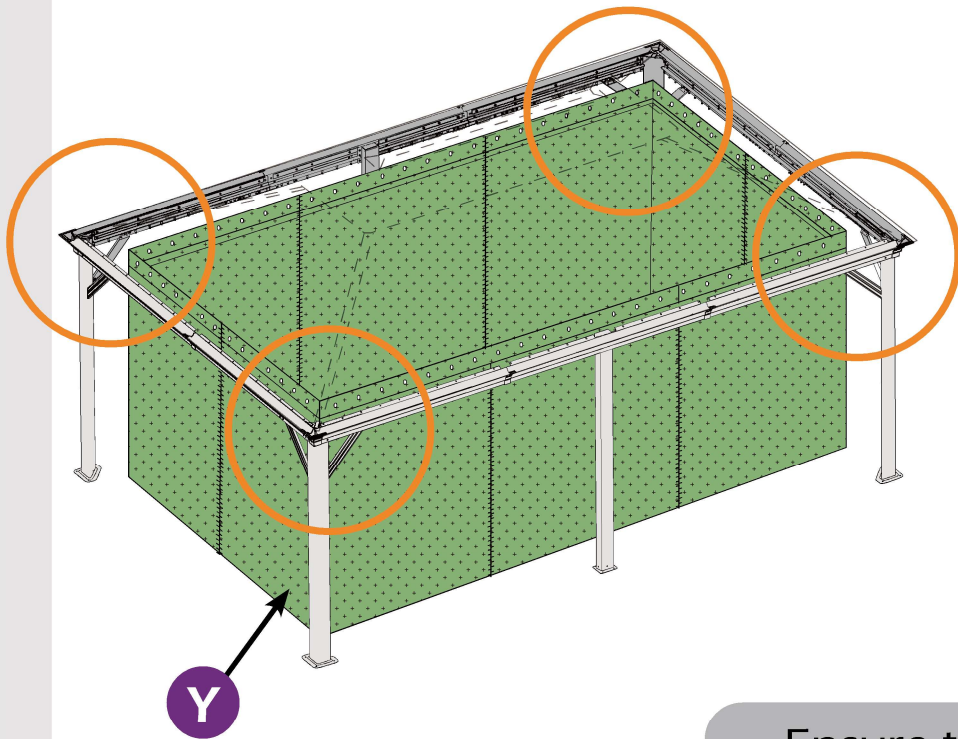

Ensure the suture line close to the pole

STEP 4

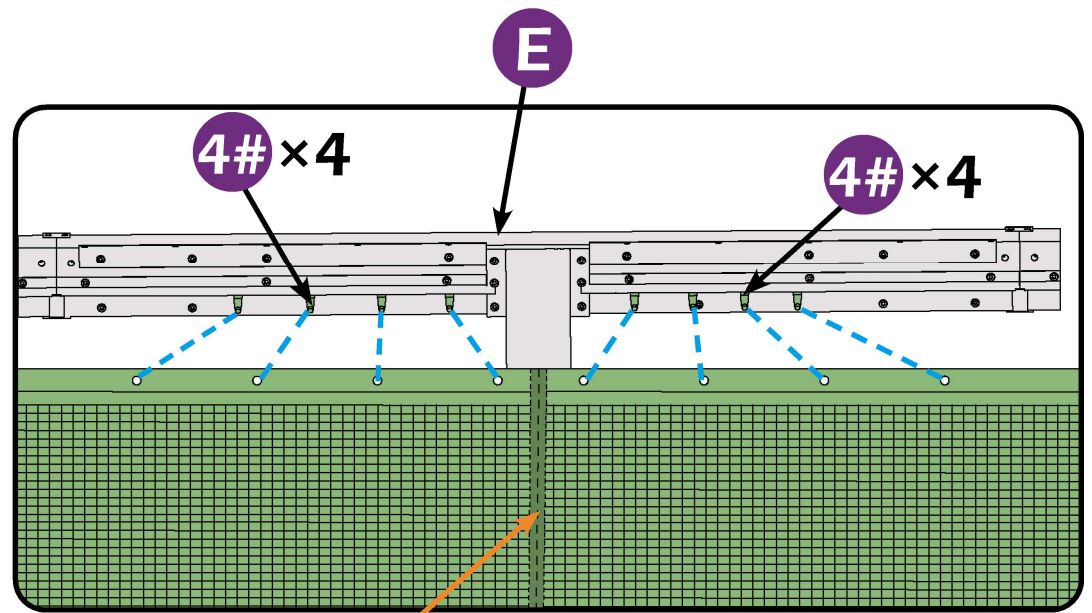
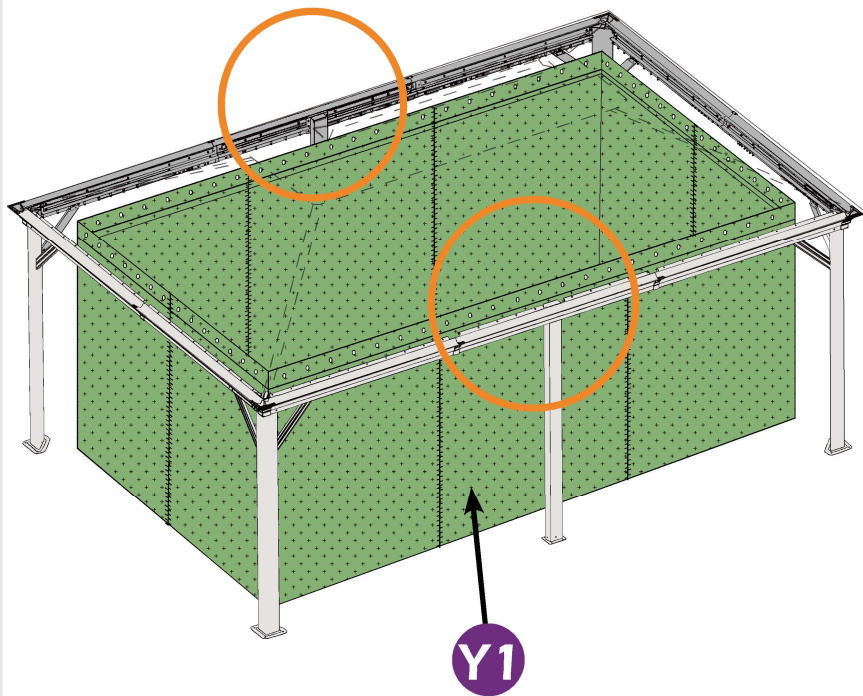

Ensure the suture line close to the pole

STEP 4

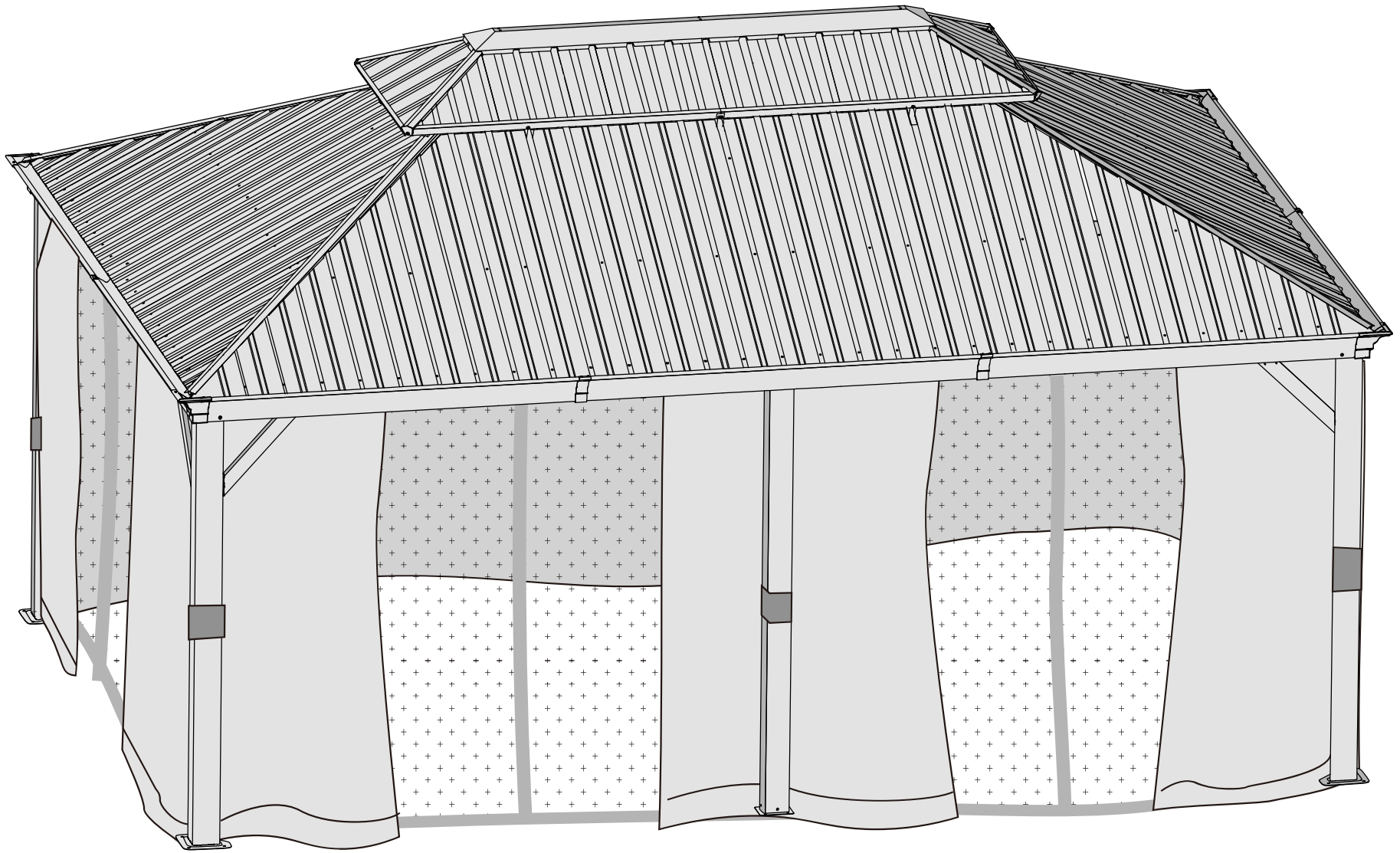

STEP 4

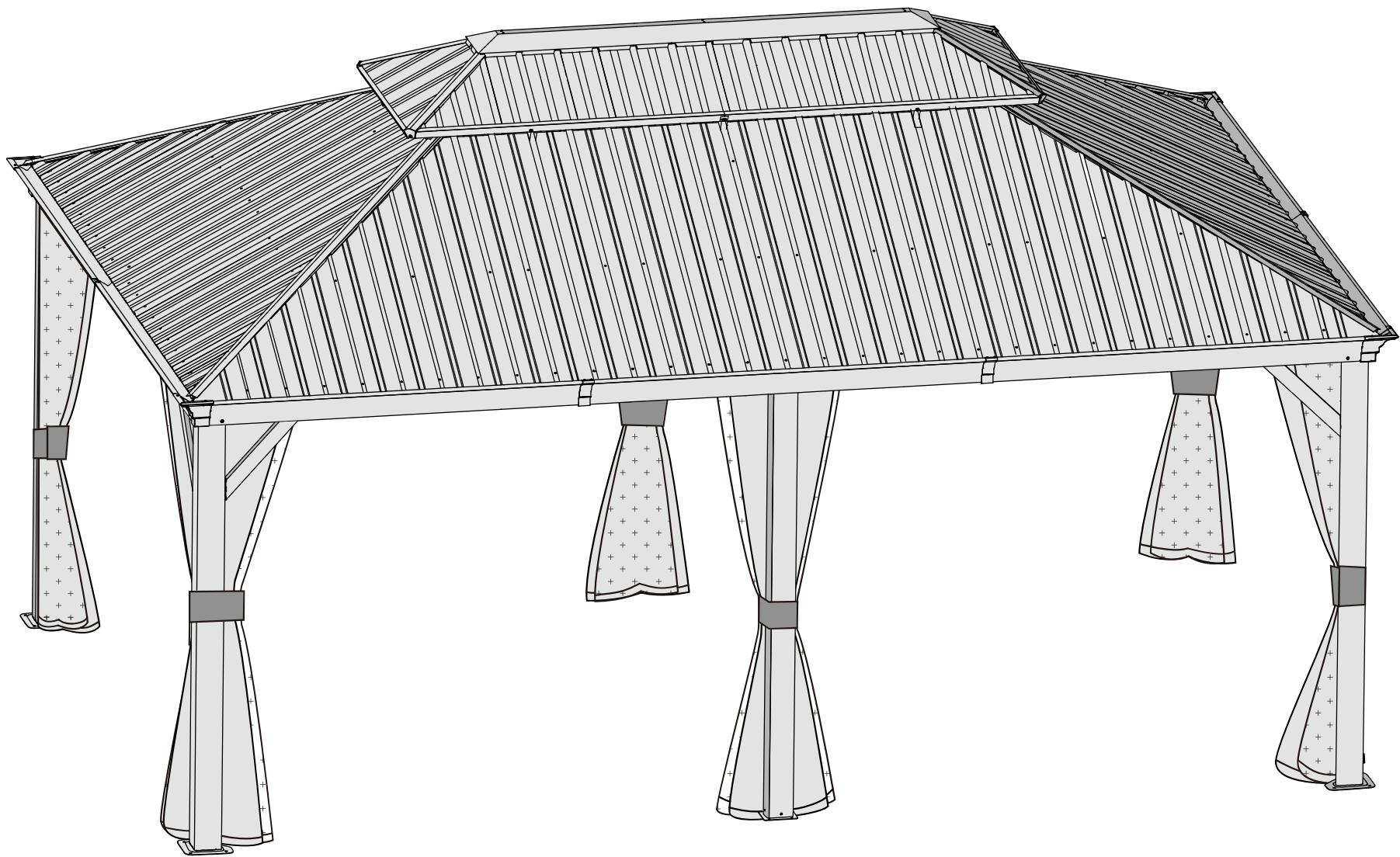

STEP 4

Care and Cleaning

Wash frame parts and fabric with mild soap and water, rinse thoroughly.

Dry frame completely and allow the fabric to drip dry.

Do not use bleach, acid, or other solvents on the fabric or frame parts.

Please inspect and tighten all bolts or fasteners on a regular basis to ensure proper performance and safety of your gazebo.

Warranty

Frames

Frames constructions are warranted to be free from defects in material and workmanship for 1 year from item purchased. Damage to frame from negligence won't be covered by this warranty.

Netting

Netting are warranted to be free from defects in material and workmanship for 1 year from item purchased. Damage from exposure to chemicals (including but not only oils ,spills, fluids) won't be covered by this warranty.

Bolts & nuts

Bolts and nuts are warranted to be free from defects in material and workmanship for 1 year from item purchased. Damage from exposure to chemicals (including not only oils ,spills, fluids) won't be covered by this warranty.

Warranty Limitation

This warranty is for the original purchase order only. (Order number required). This warranty is non-transferable. Domi outdoor living is responsible for the free replacement part including shipping charges for the 1 year warranty.

Warranty Exclusion

This warranty does not cover products subject to negligence, abuse usage, inappropriate installation. Domi outdoor living reserves the right to explain warranty exclusions. When the replacement item is applied, the 1 year warranty automatically expires. Please feel free to contact us for applying warranty.