



12'x20'

SKU: LGMF1499A

**HARDTOP GAZEBO
WITH DOUBLE ROOF**

Assembly Manual

MOUNTING BLUEPRINT

Gazebo 12×20

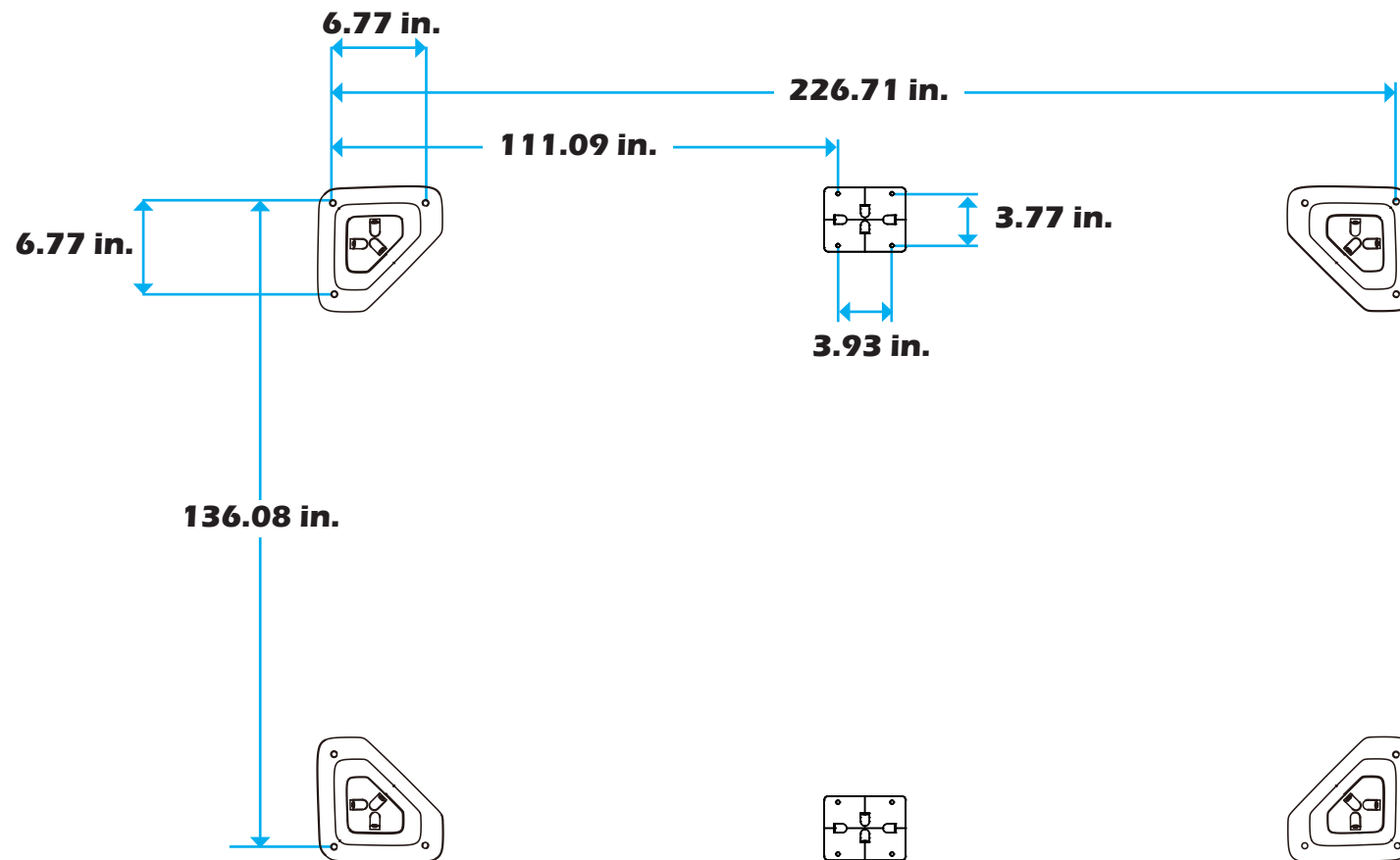

1

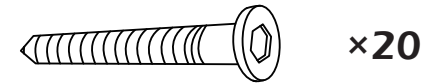
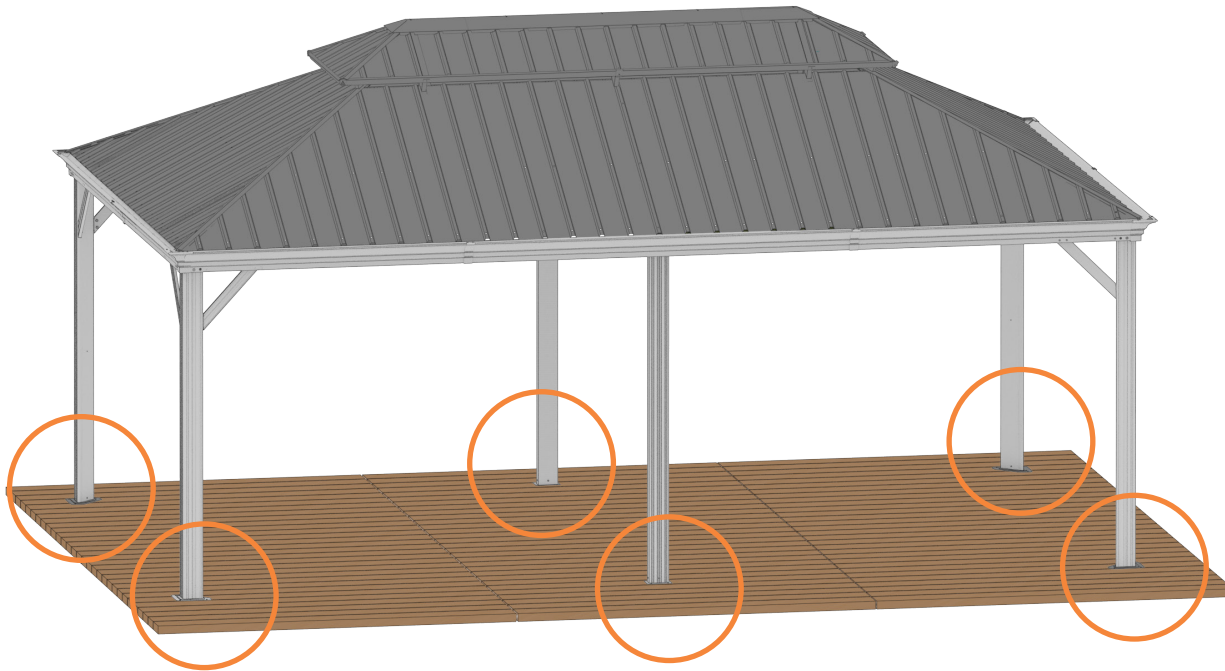

If the deck is hard wood and the depth of it is over 3 inch , you can use **5/16 in. x4 in. Structural Wood Screw** to mount the gazebo.

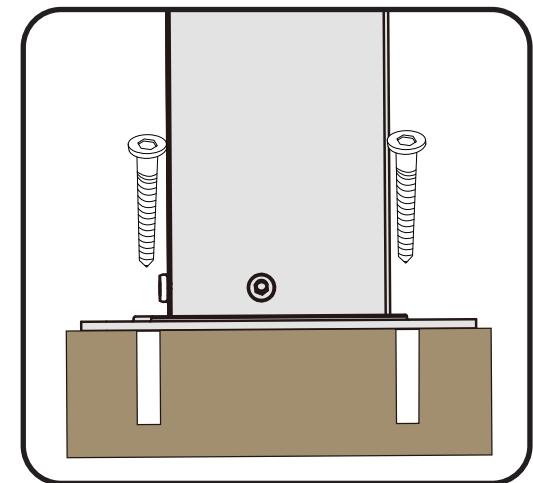
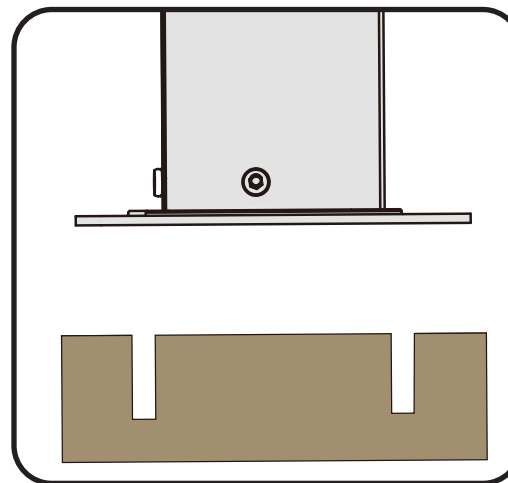

2

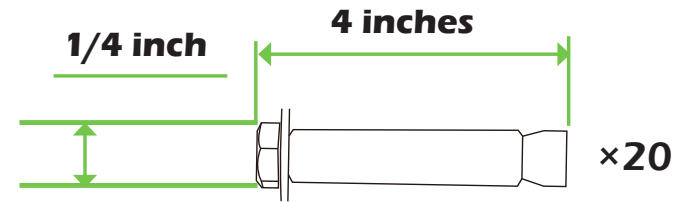
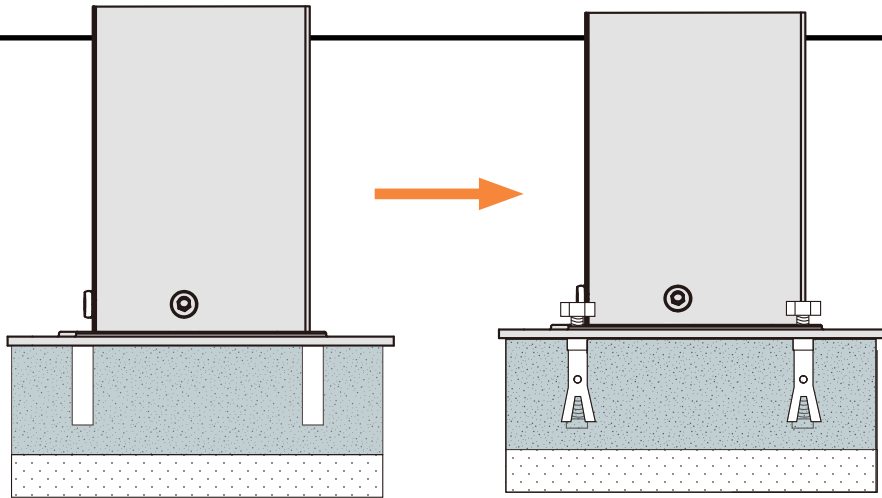

If the ground is concreted and the depth of it is over 3 inch, you can use 1/4 inch expansion bolts to mount the gazebo

3

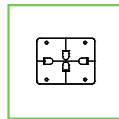
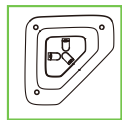

Or you can make a concrete footing for gazebo, **15×15×15 inches** is recommended. use expansion bolts to mount the gazebo like ② shows.

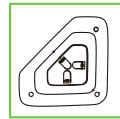
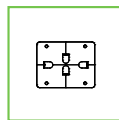
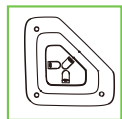

IMPORTANT:
Anchor is not recommended

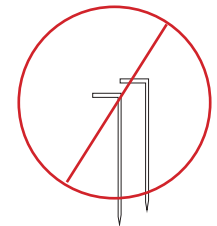

CHECK LIST

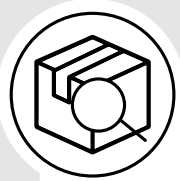

A × 4



B × 2

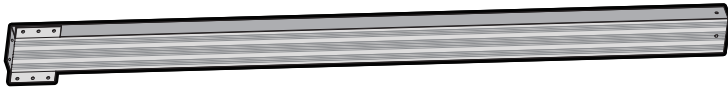

C × 4



C1 × 4



C2 × 2

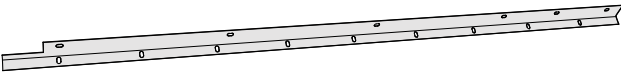

C3 × 2



D × 4



D1 × 4



D2 × 2

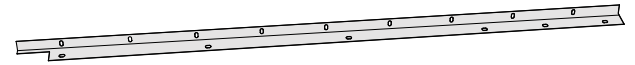

D3 × 2

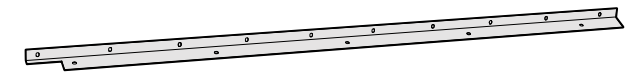

E × 2

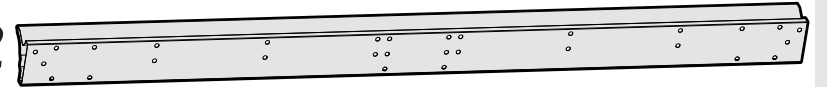

E1a × 2

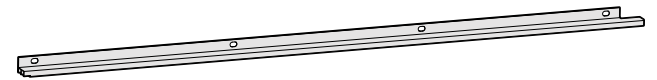

E2a × 2

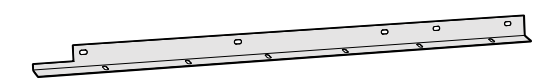

E1b × 2

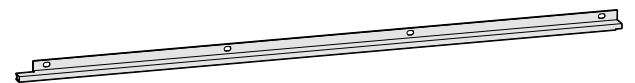

E2b × 2

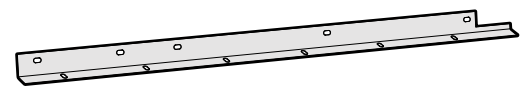

F × 6

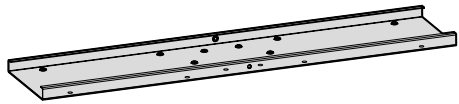

G × 4

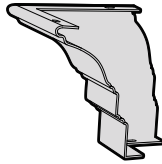

H × 6

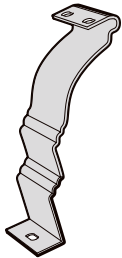

H1 × 6

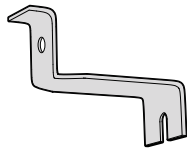

H2 × 1

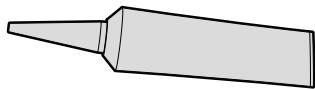

J1 × 4



J2 × 4



K × 1

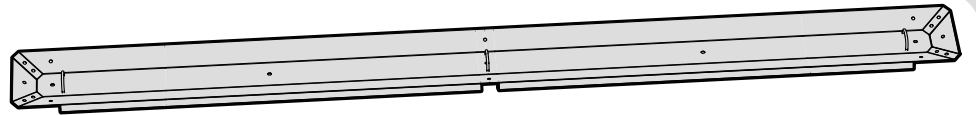

K1 × 1

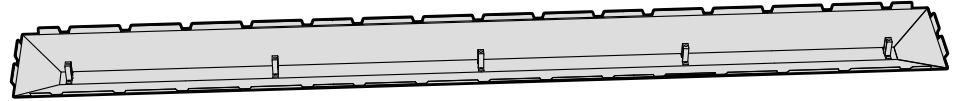

L × 4

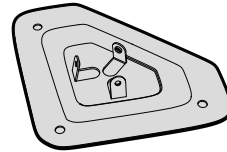

L1 × 2

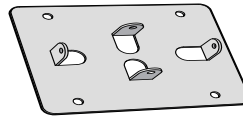

M × 4



N × 2



N1 × 4



N2 × 2

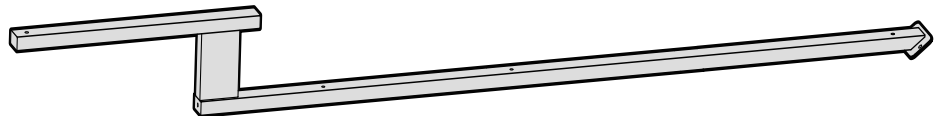

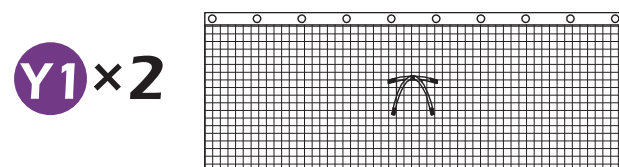
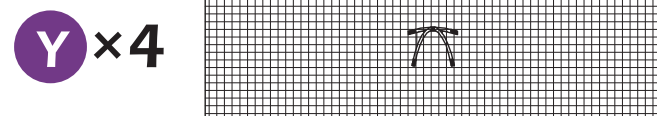
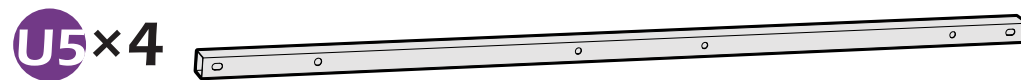
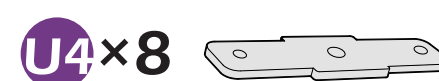
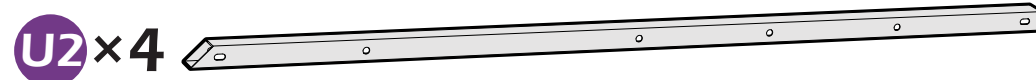
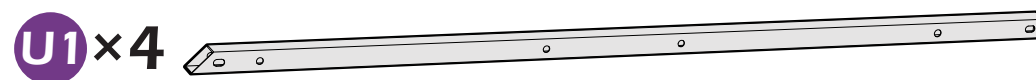
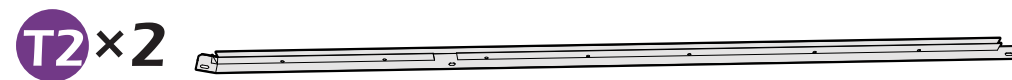
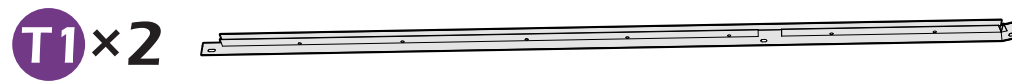
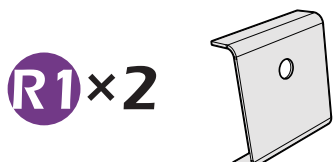
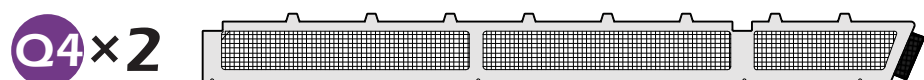
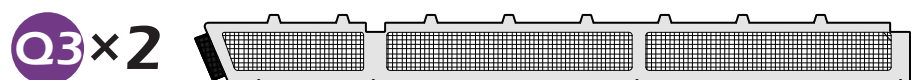
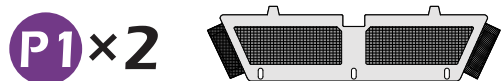
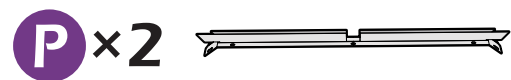

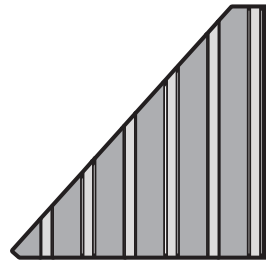

V1×2

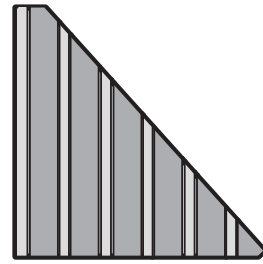

V2×2

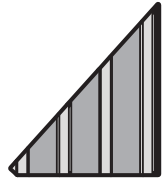

V3×2

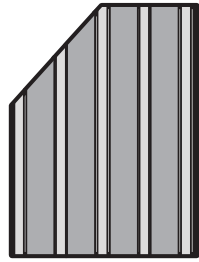

V4×2

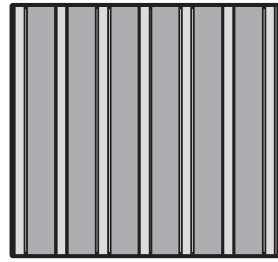

V×8

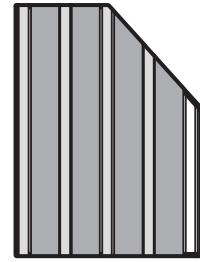

V5×2

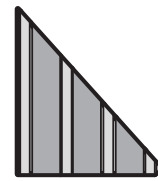

V6×2



W1×2

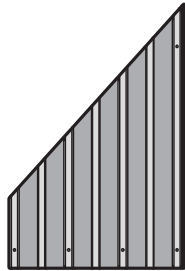

W2×2

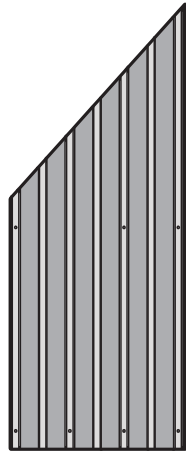

W3×2

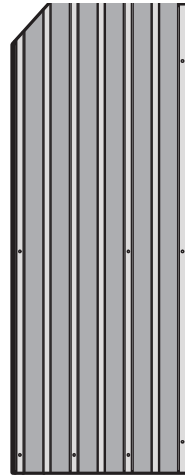

W4×2

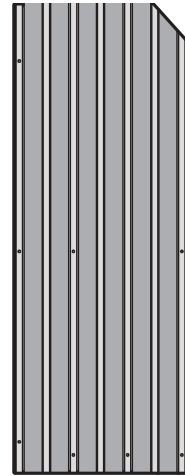

W5×2

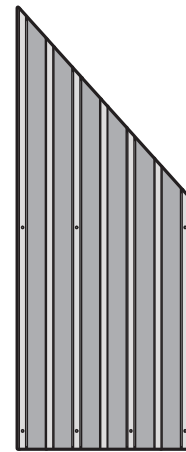

W6×2

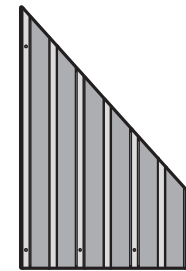

W7×2



W8×2

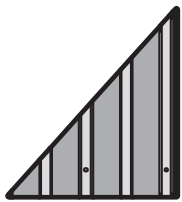

X1×2

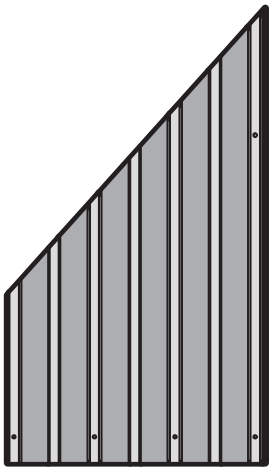

X2×2

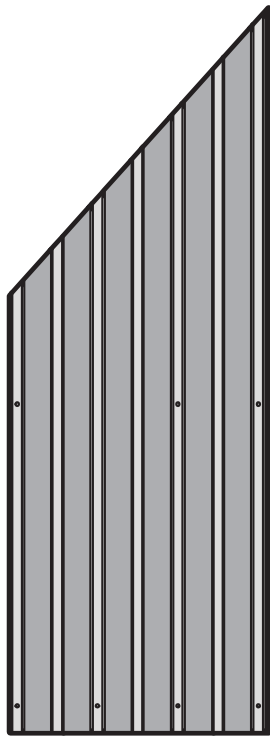

X3×2

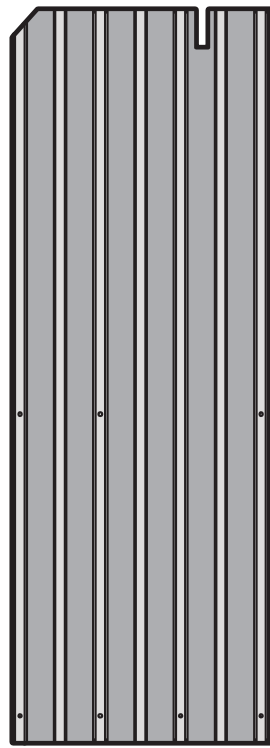

X4×2

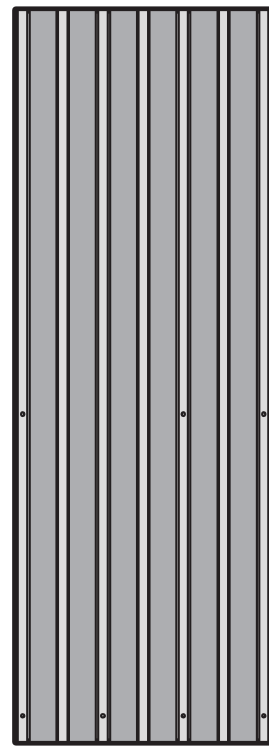

X5×2

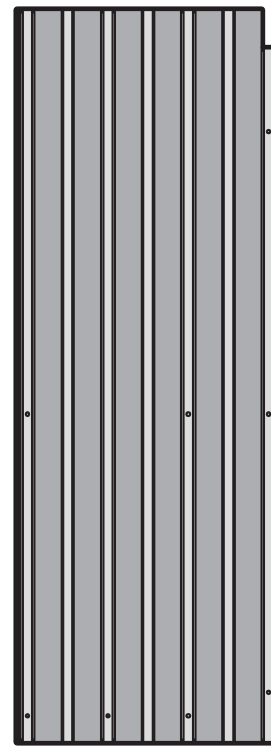

X6×2

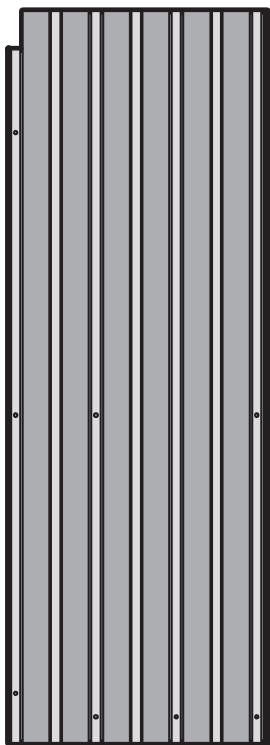

X7x2

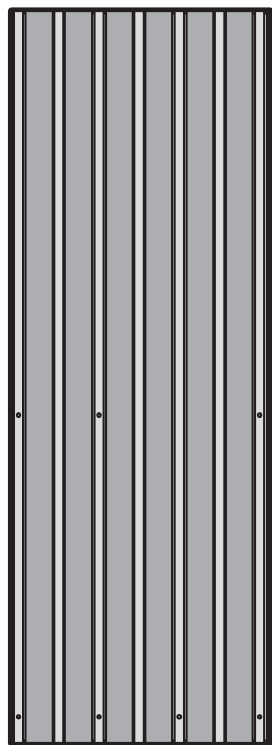

X8x2

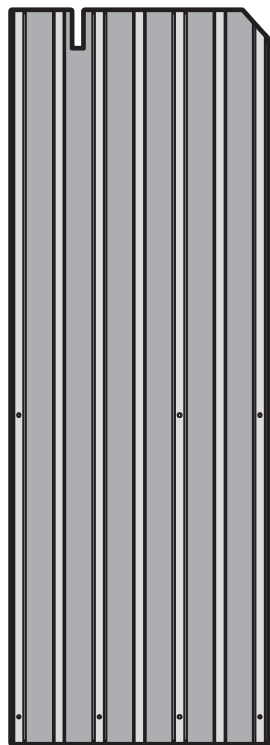

X9x2

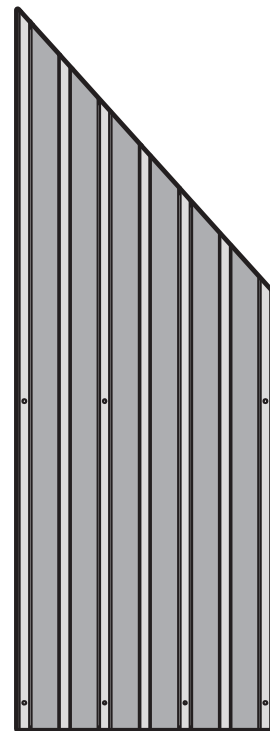

X10x2

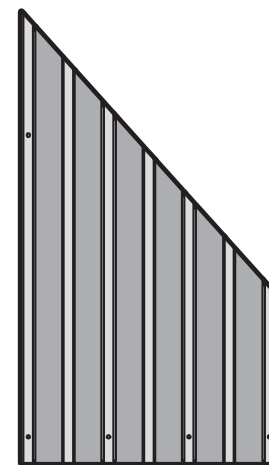

X11x2

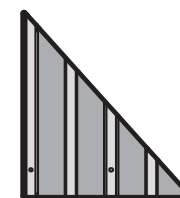

X12x2

Z×72



4#×152

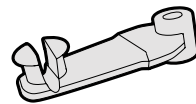

10#×4

(M6×25)

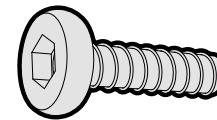

Z1×6



5#×100

(M6×28)

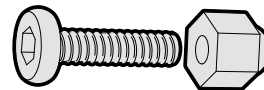

11#×12

(M6×10)

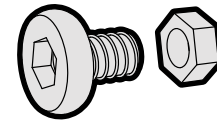

Z2×6



Z3×2



6#×8

(M6×45)

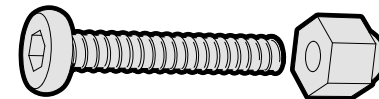

12#×1

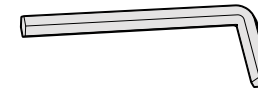

Z4×2



7#×48

(M6×50)

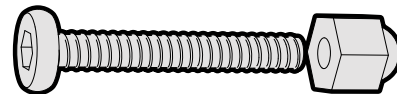

14#×1

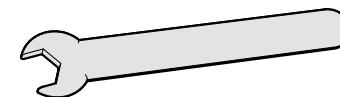

1#×301

(M6×16)

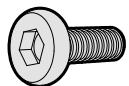

8#×6

(M5×16)

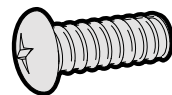

15#×1

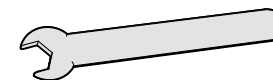

2#×28

(M6×20)

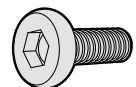

9#×28

(ST4.8×13)

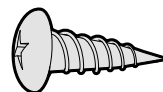

3#×16



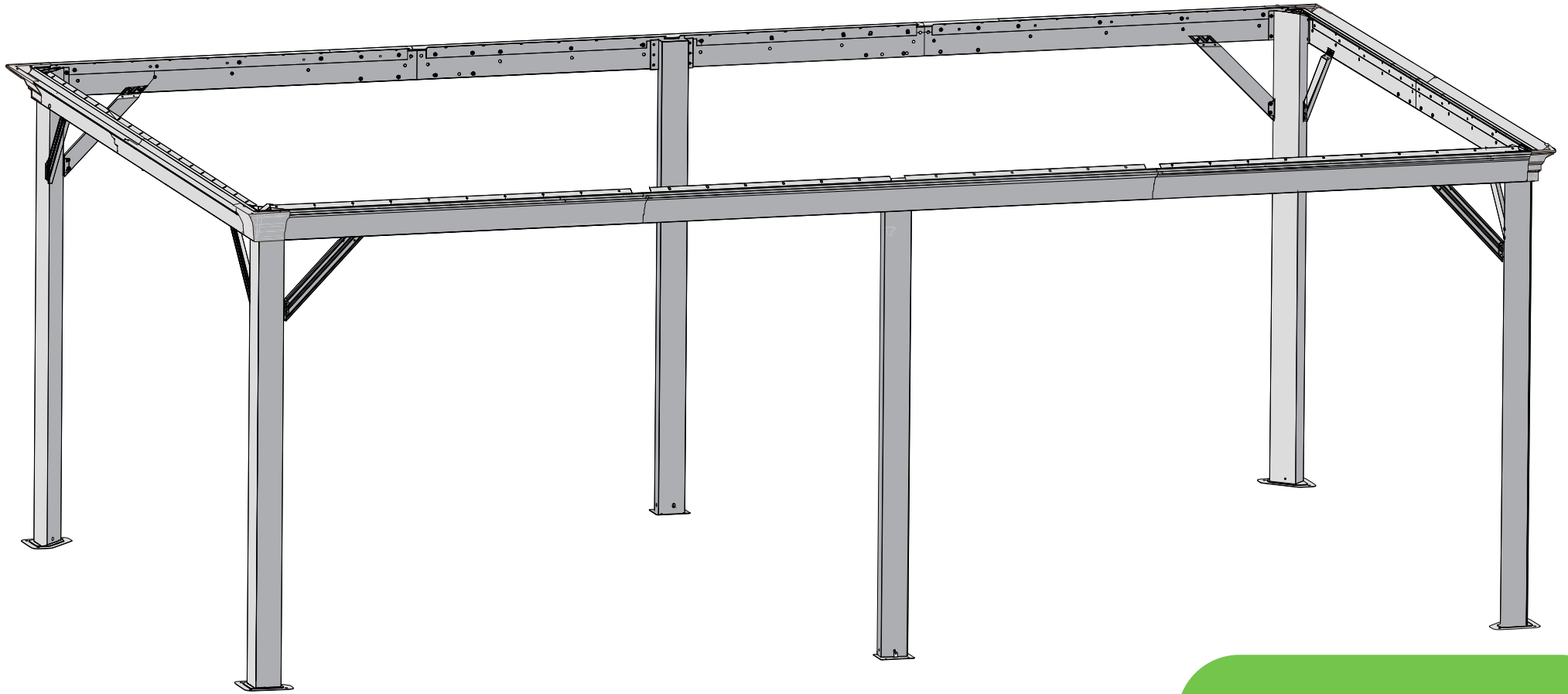

STEP 1

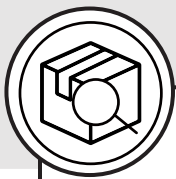

A × 4

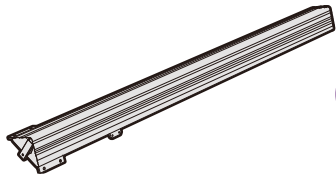

L × 4

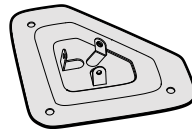

1# × 12

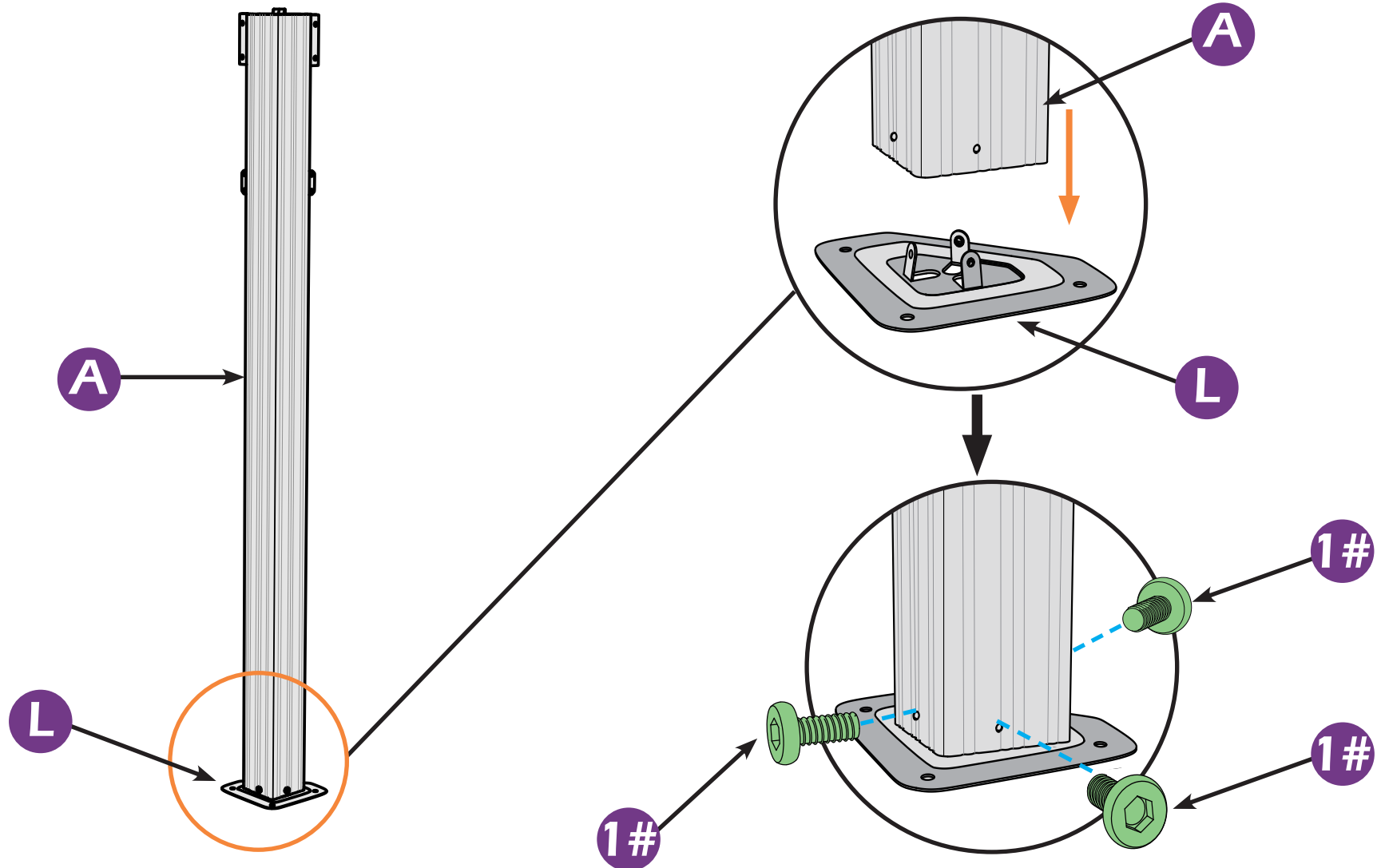
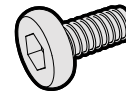

STEP 1

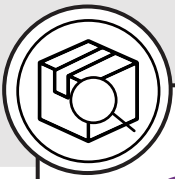

B × 2

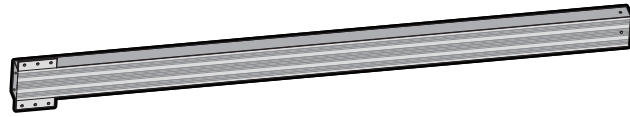

L1 × 2

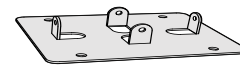

1# × 8

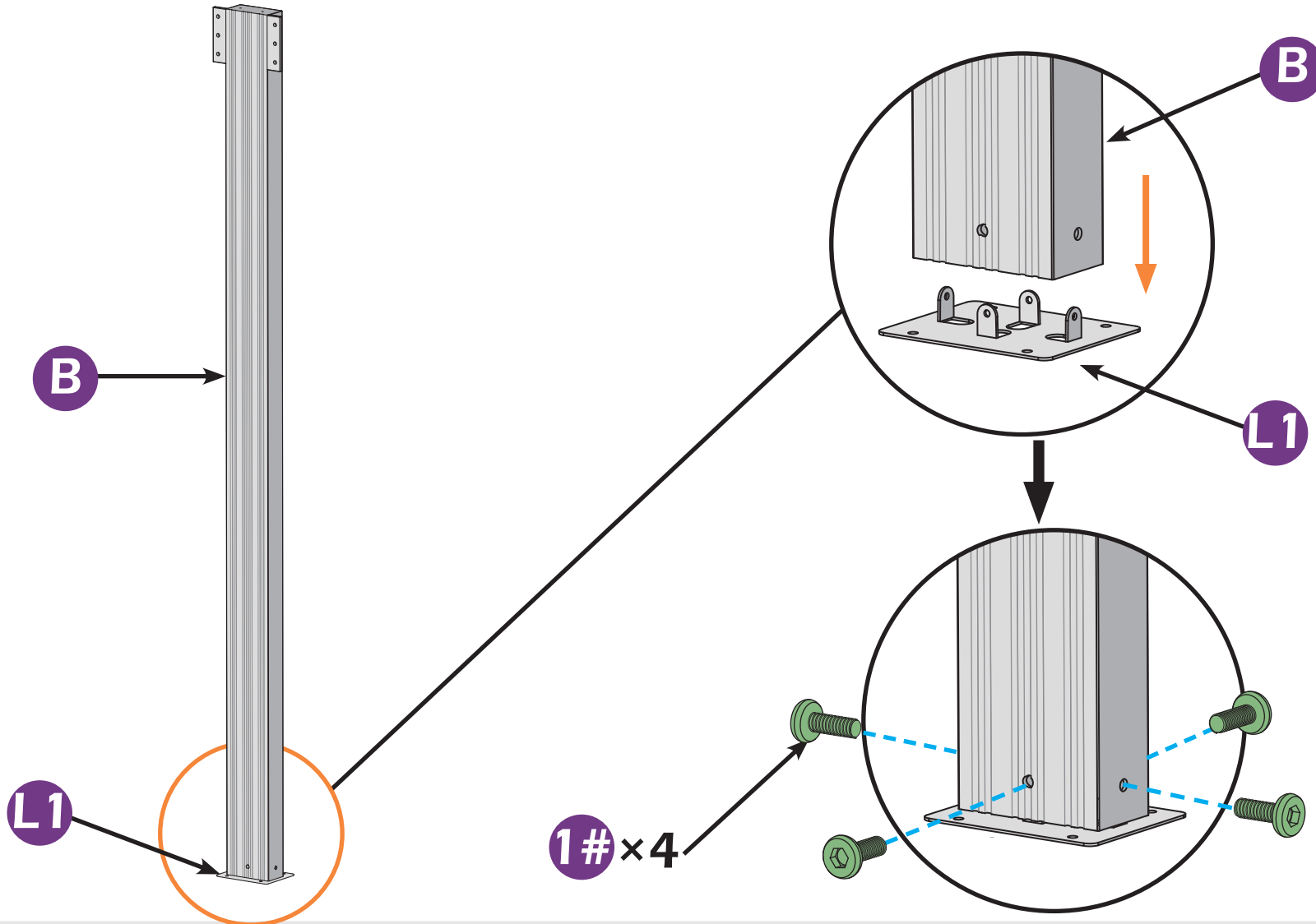
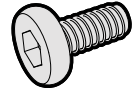

STEP 1



C × 2

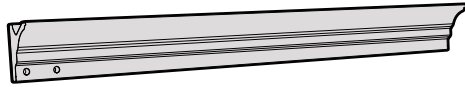

F × 2

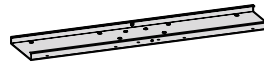

D × 2

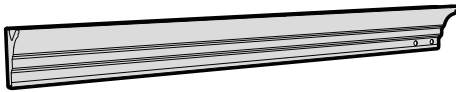

1# × 8

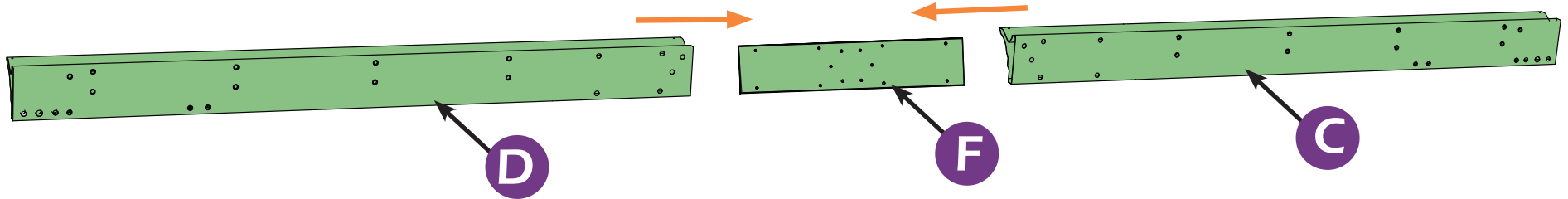
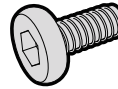

STEP 1

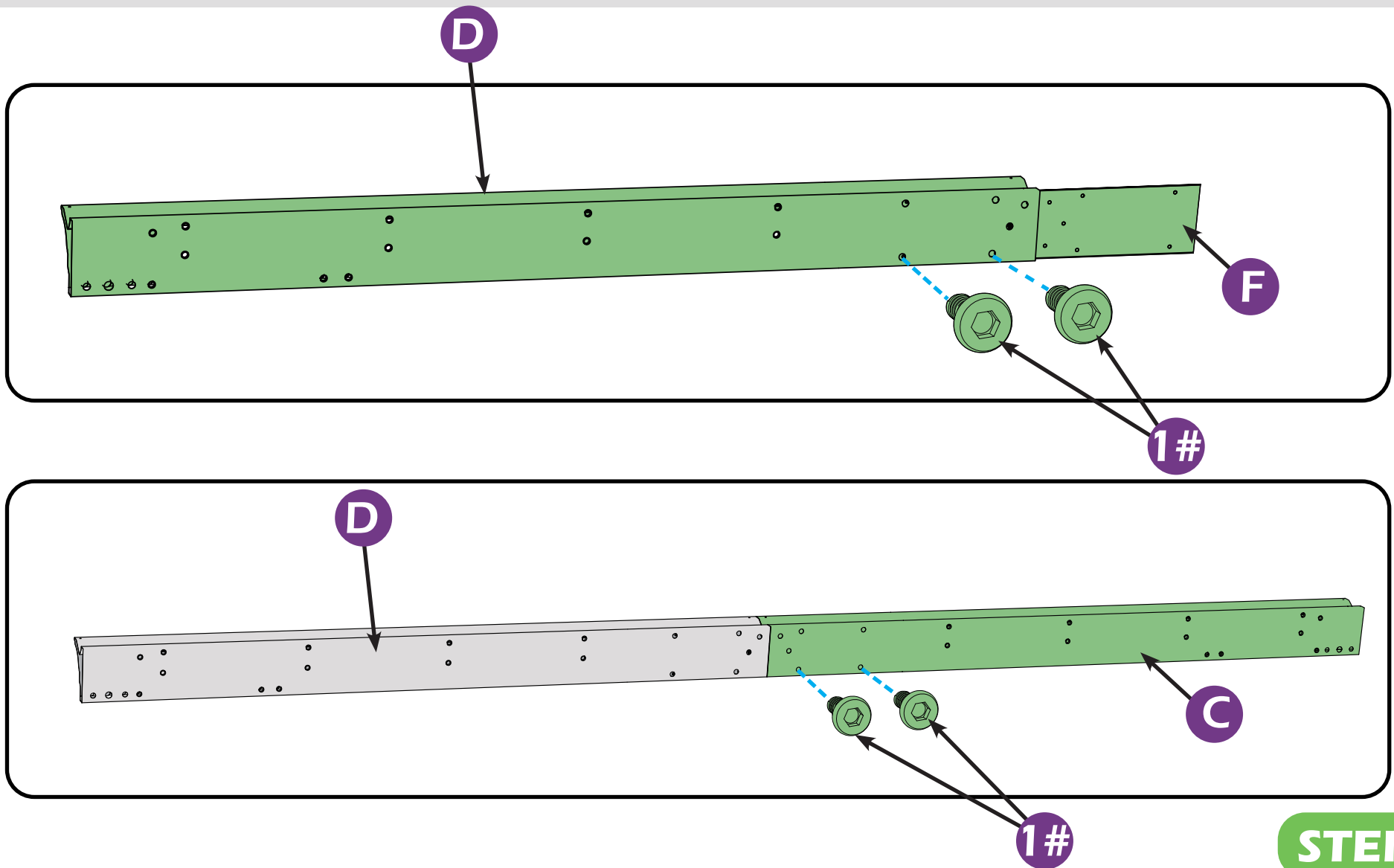

STEP 1

▲ It's a normal situation that there's a gap between the 2 beams, please use silicone sealant (part #H2) and bracket #H to affix the gap.(see P56-57)

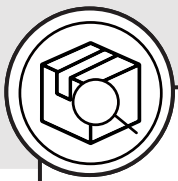

D2 × 2

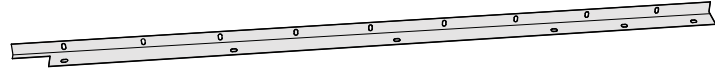

1# × 24

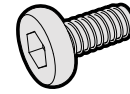

C2 × 2

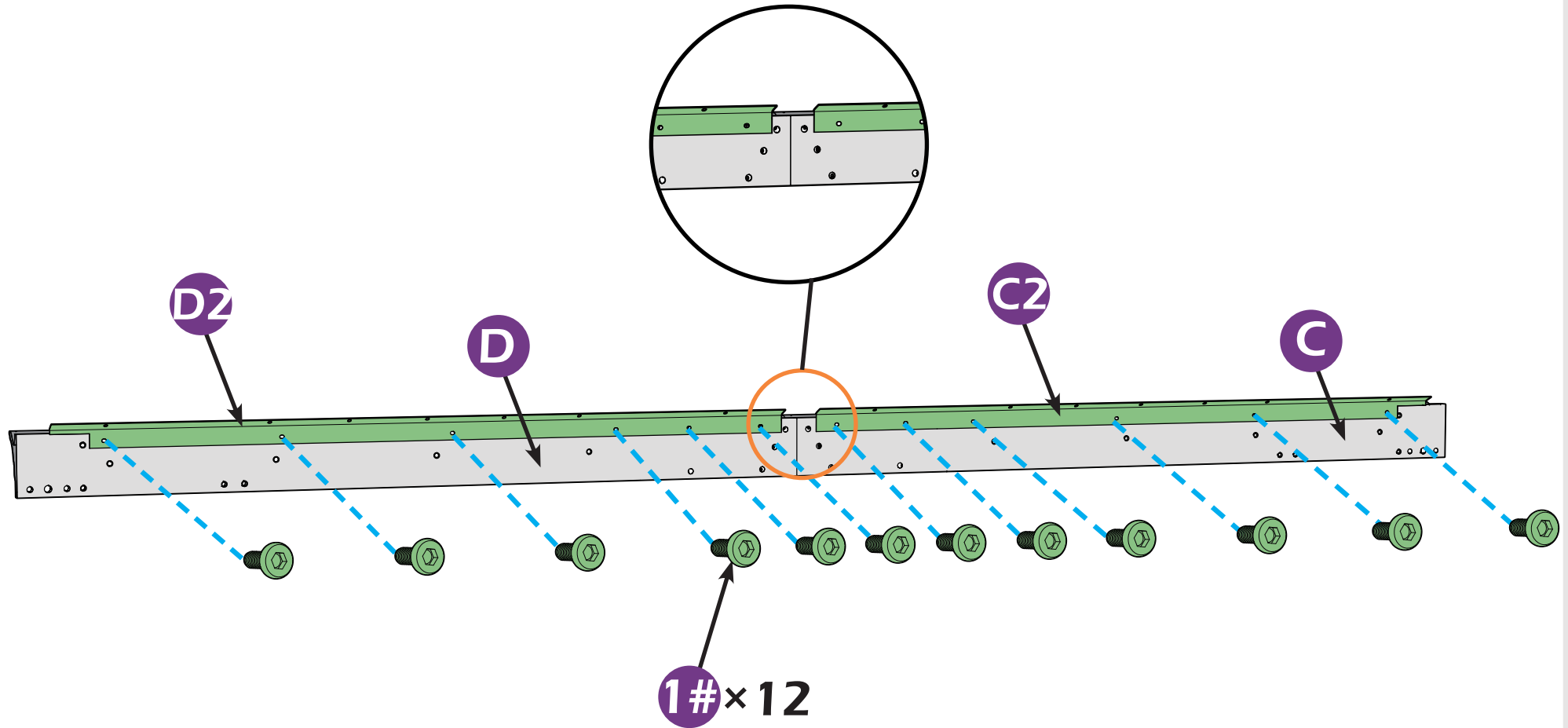
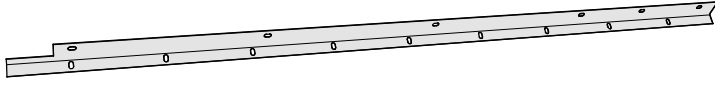

STEP 1



C × 2



F × 4

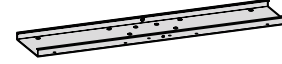

D × 2



1# × 16

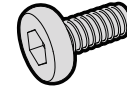

E × 2

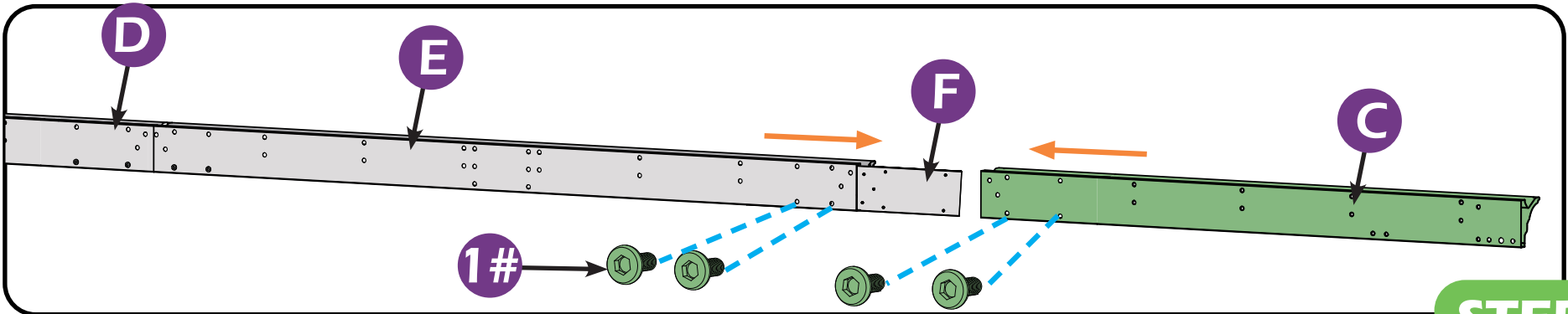
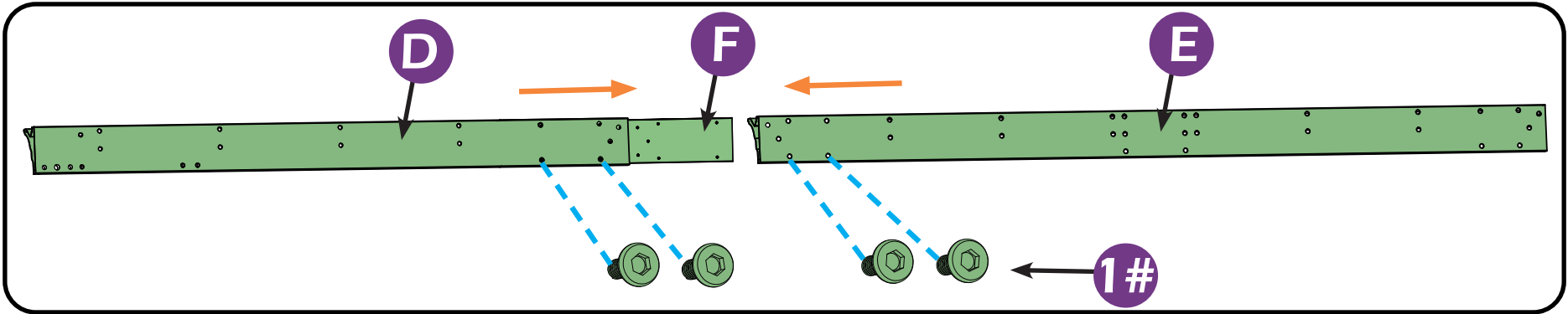
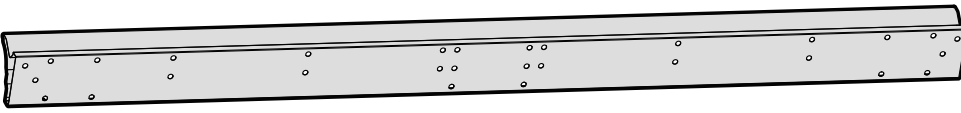

STEP 1

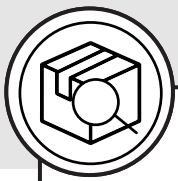

D3 × 2

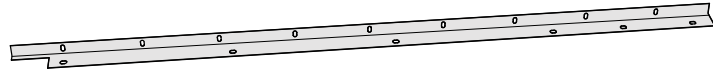

1# × 44

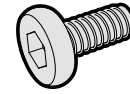

C3 × 2

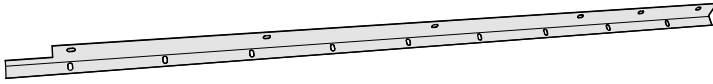

E2a × 2

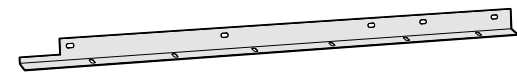

E2b × 2

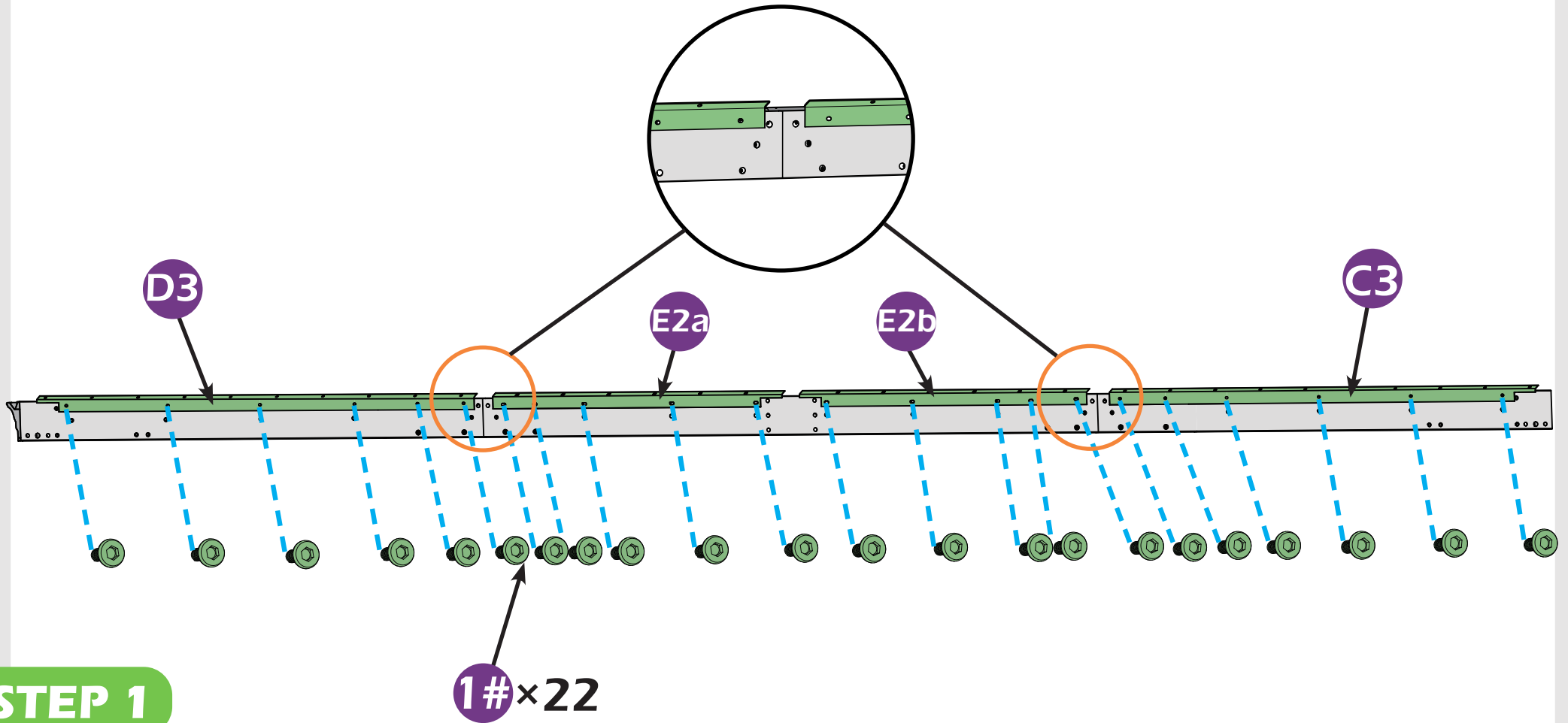
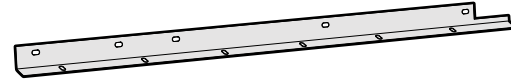

STEP 1

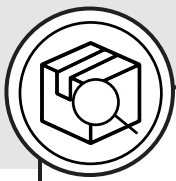

2# × 28 

3# × 16 

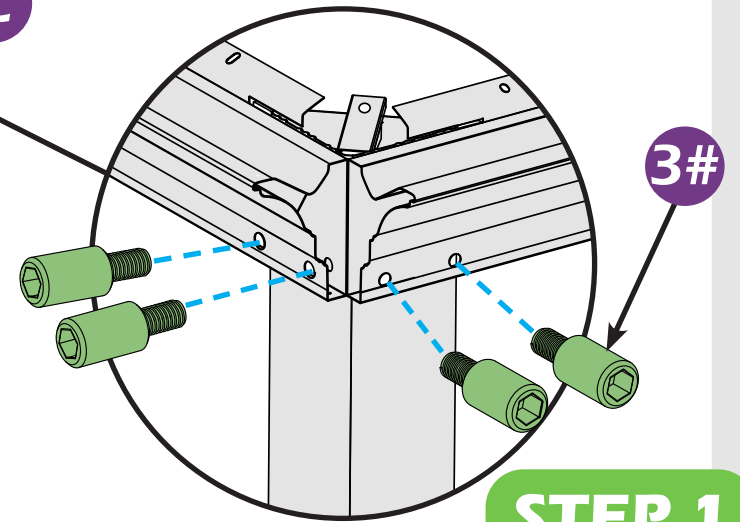
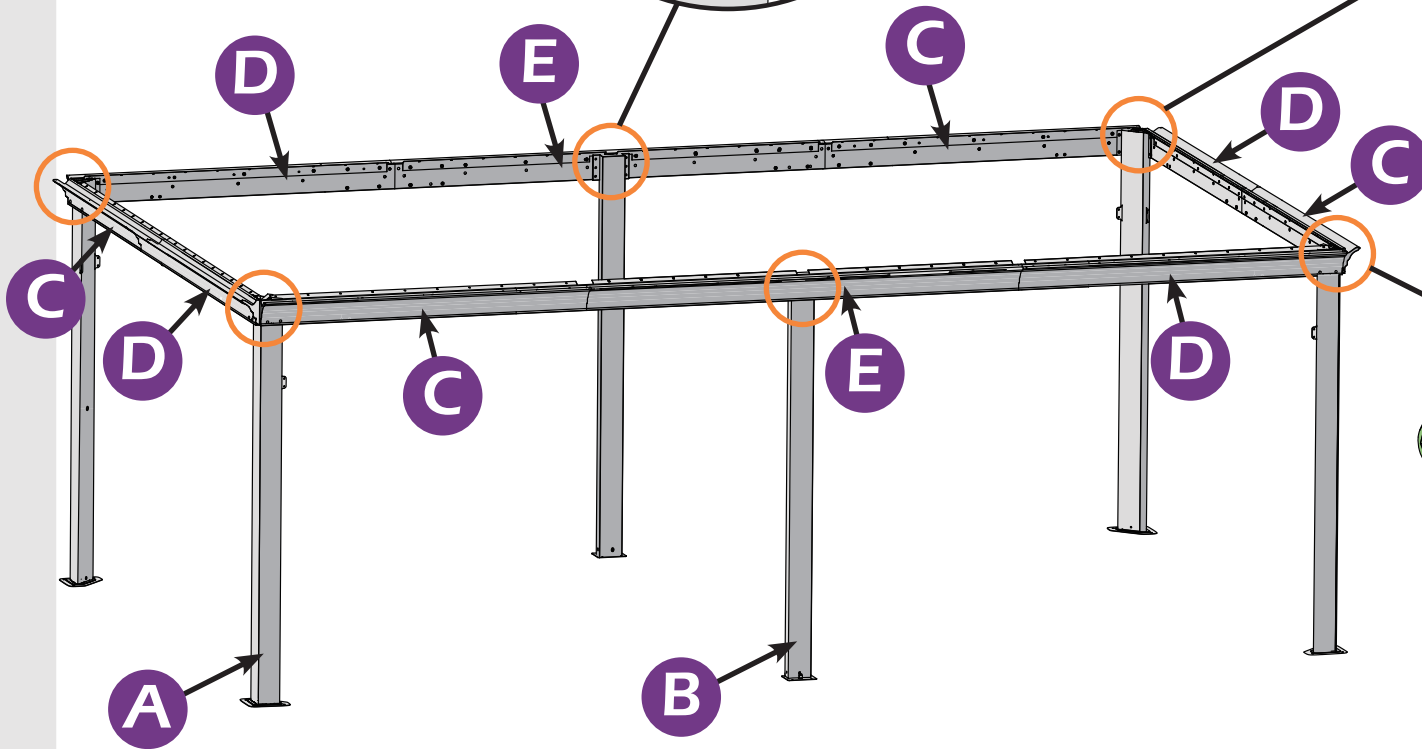
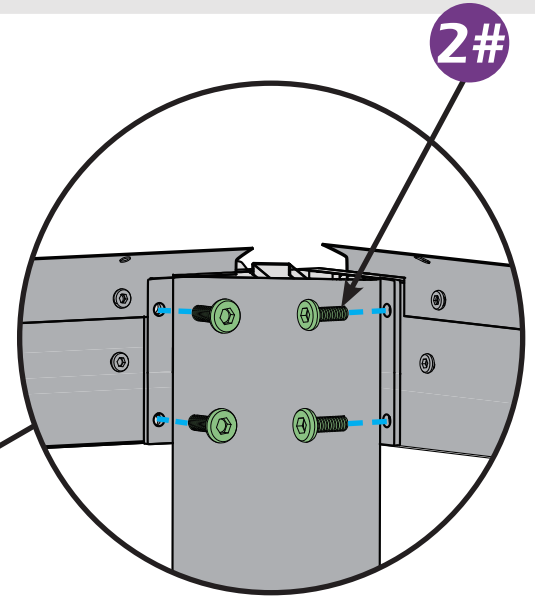
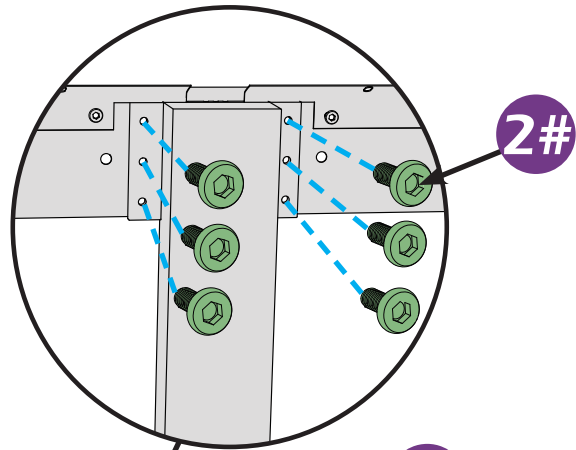

STEP 1

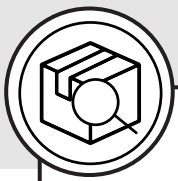

J1 × 4



1# × 32

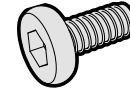

J2 × 4

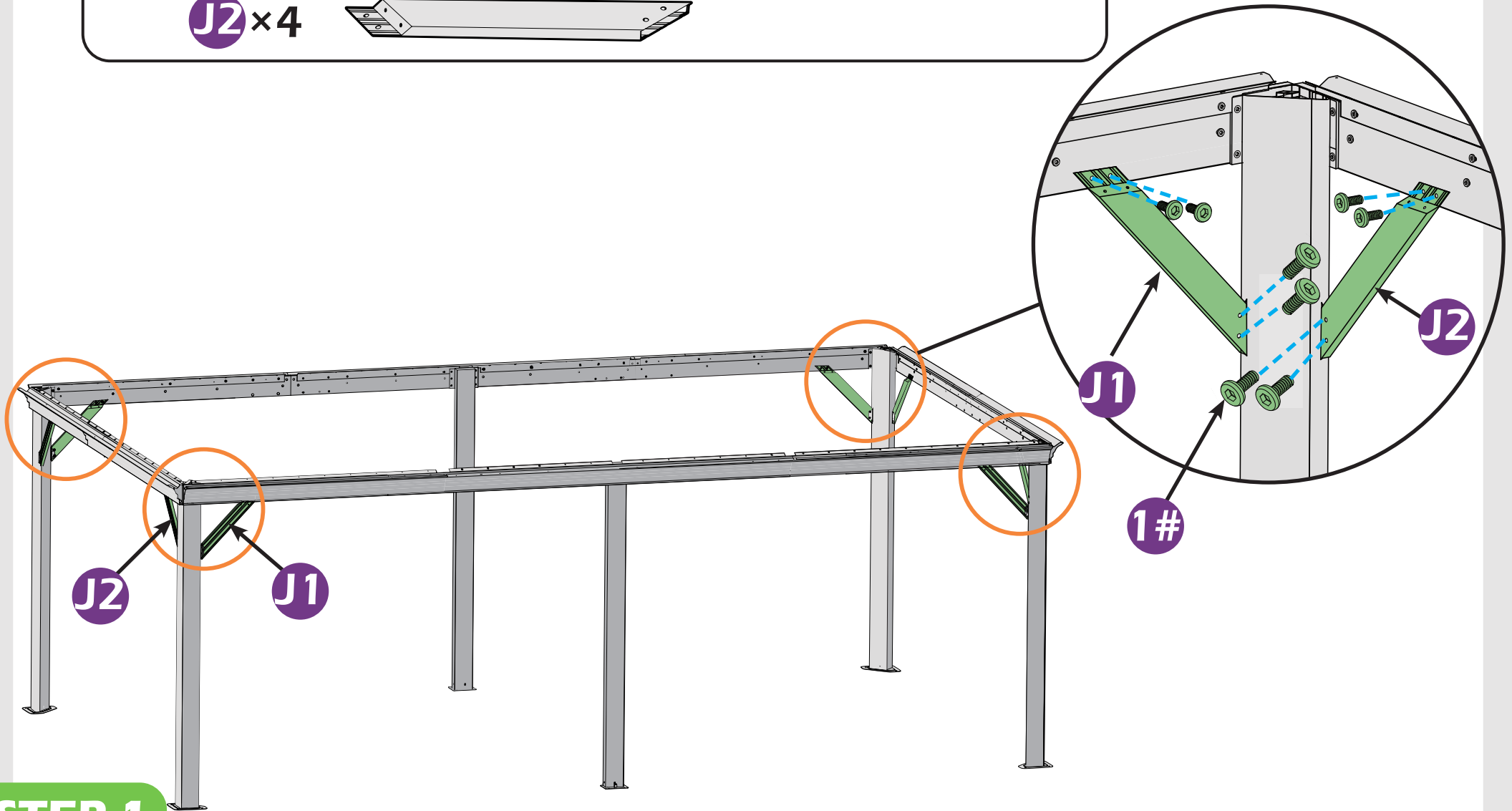

STEP 1



G × 4

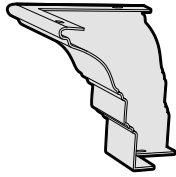

9# × 16

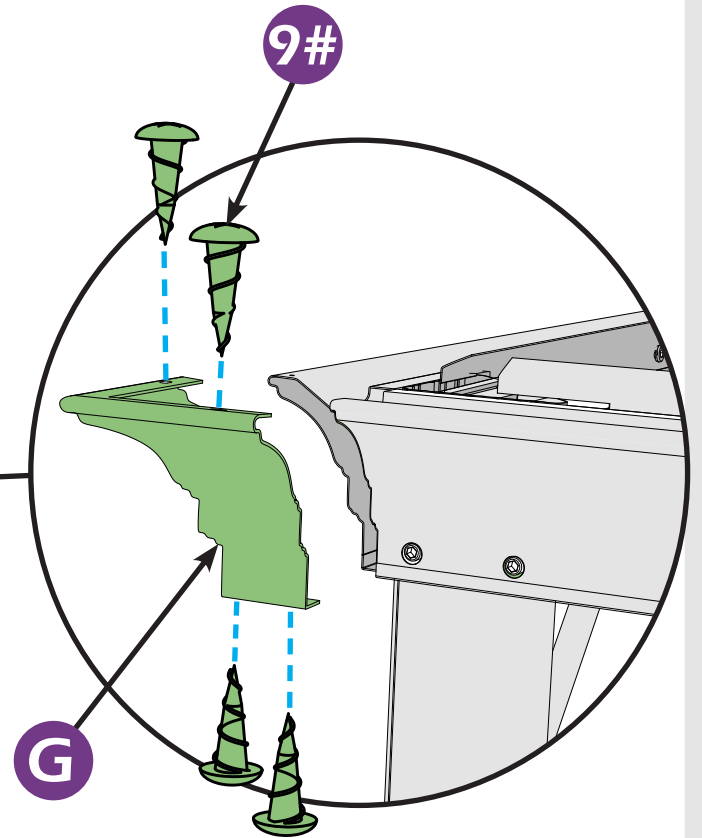
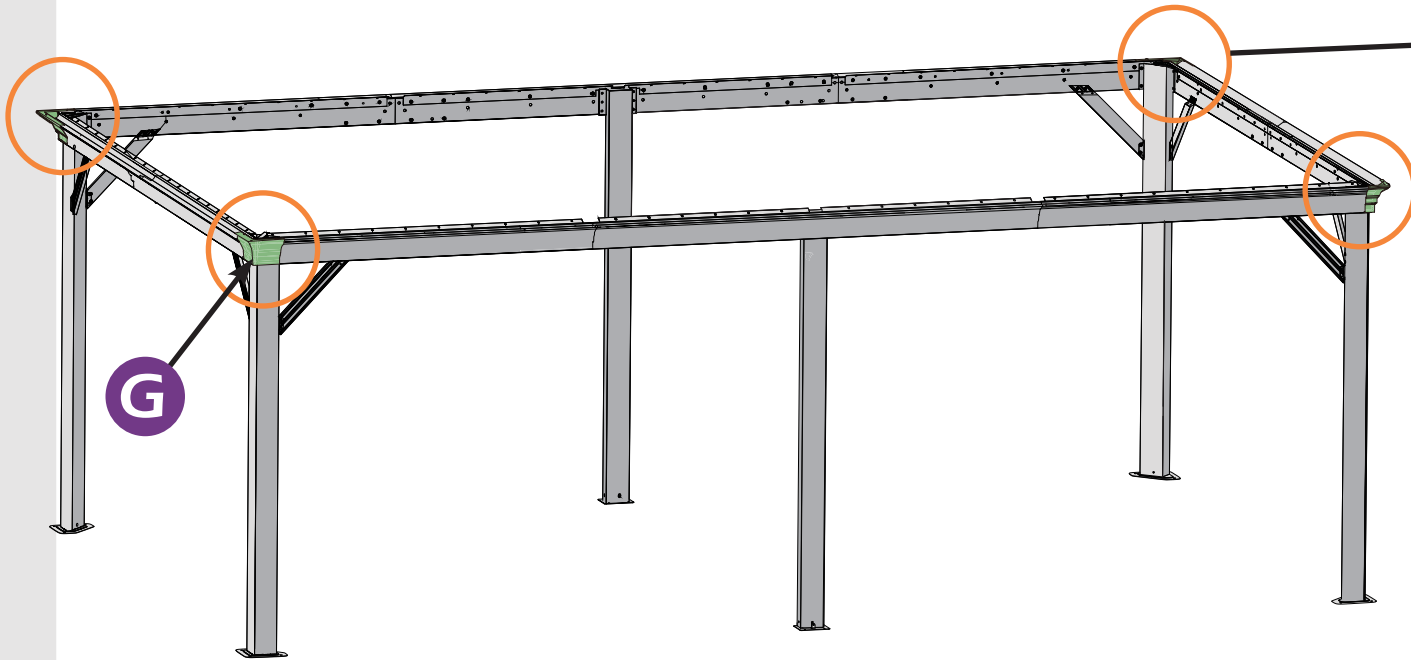
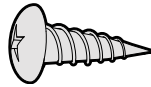

STEP 1



STEP 2

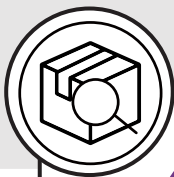

K × 1

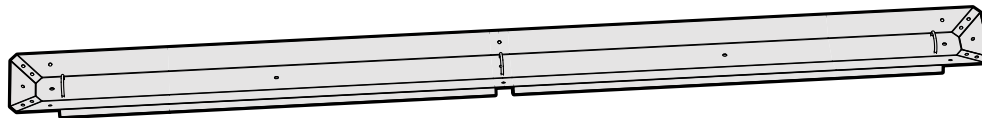

1# × 5

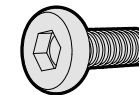

K1 × 1

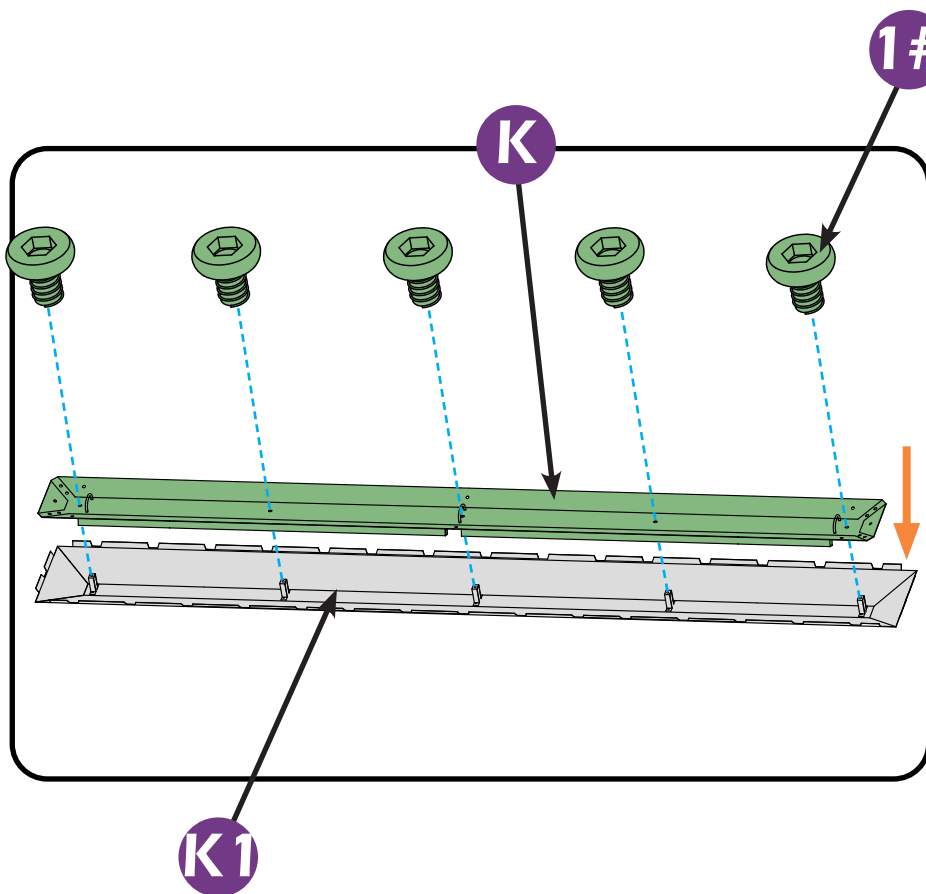
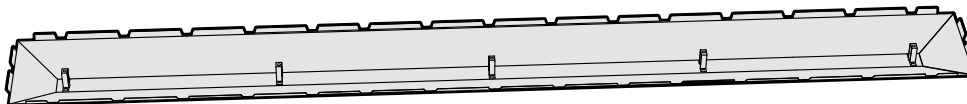

Don't fully tighten the screw **1#**, It might cause problem on roofs installation.

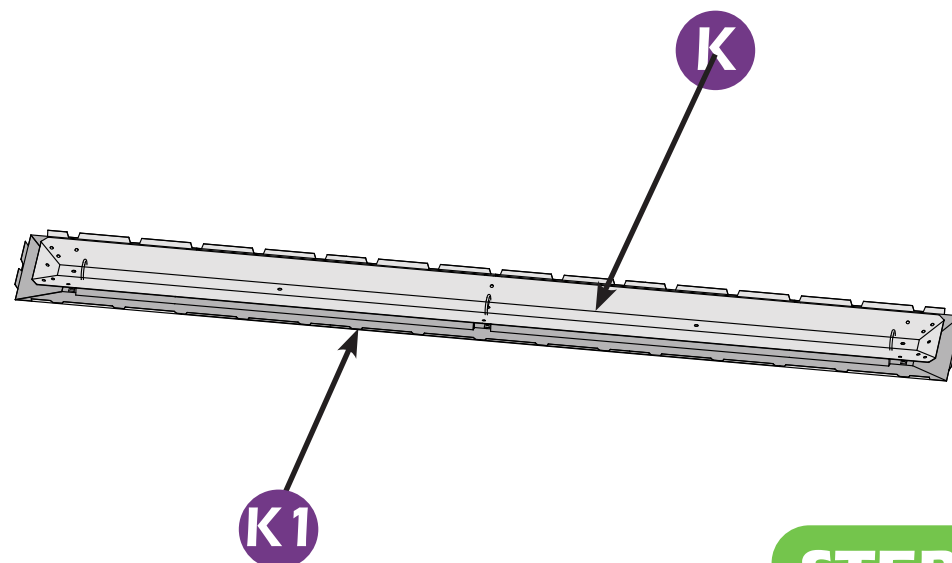

STEP 2

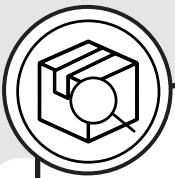

M × 1



N × 1



1# × 3

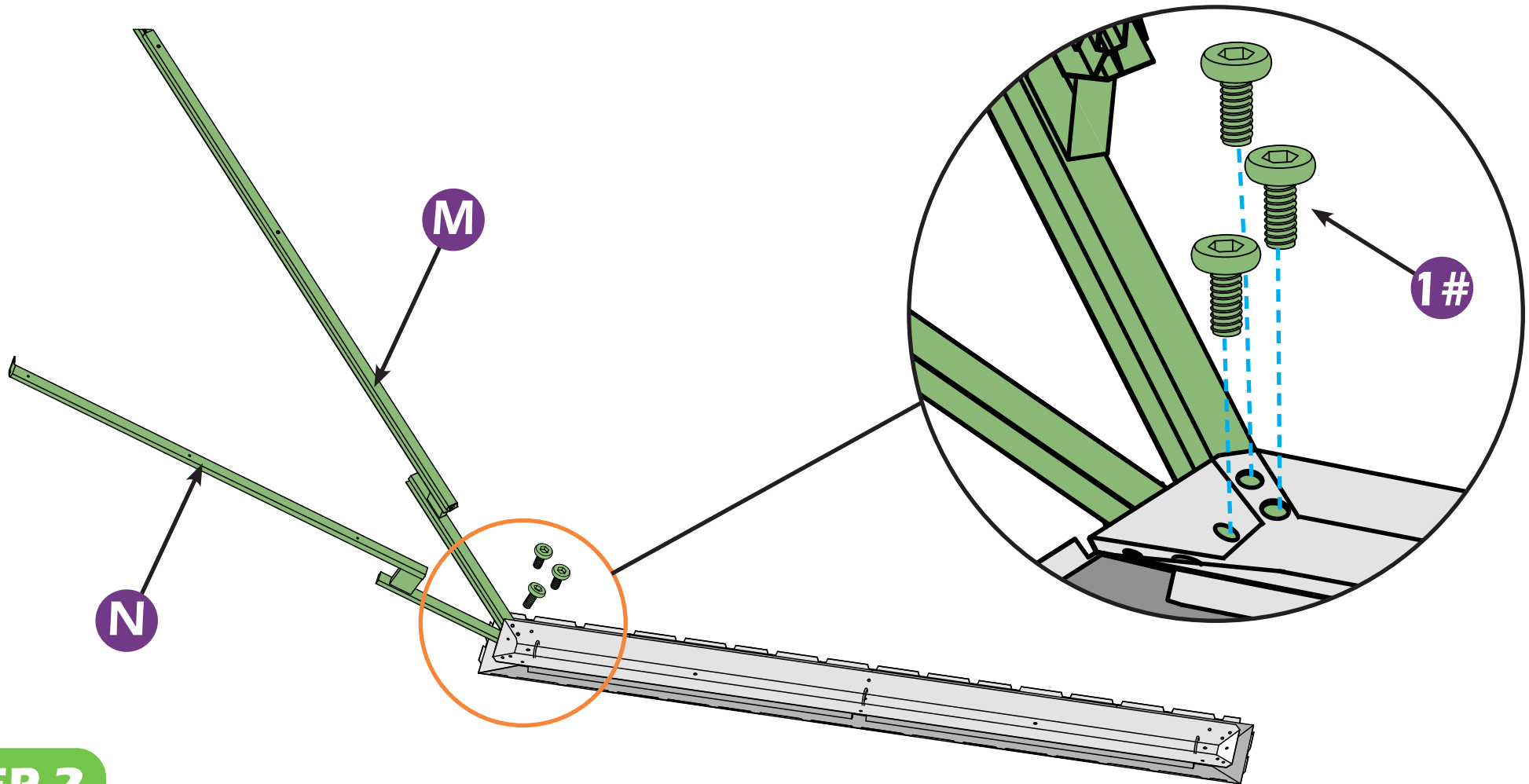
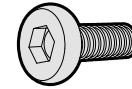

STEP 2

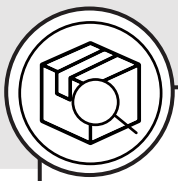

1# x 3

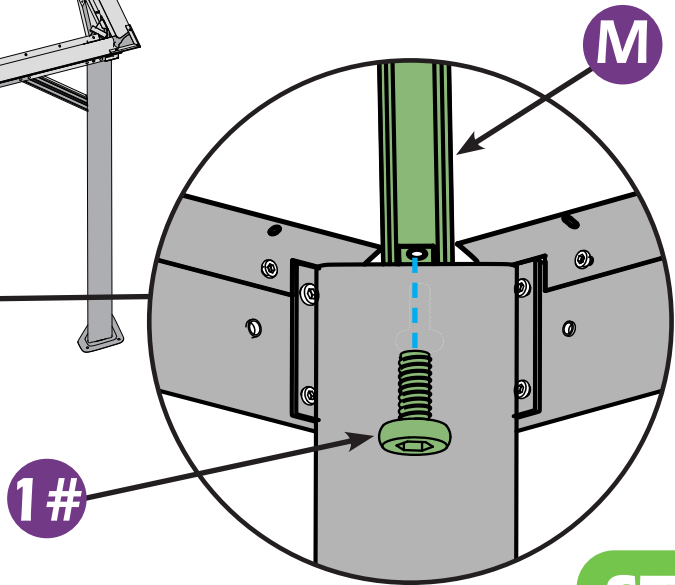
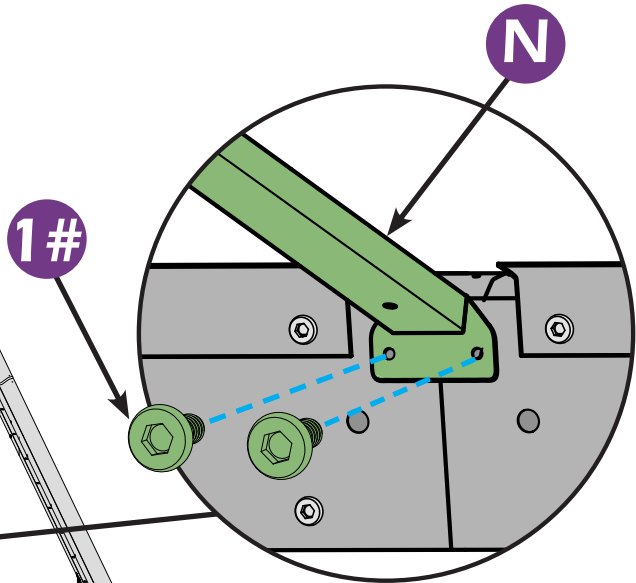
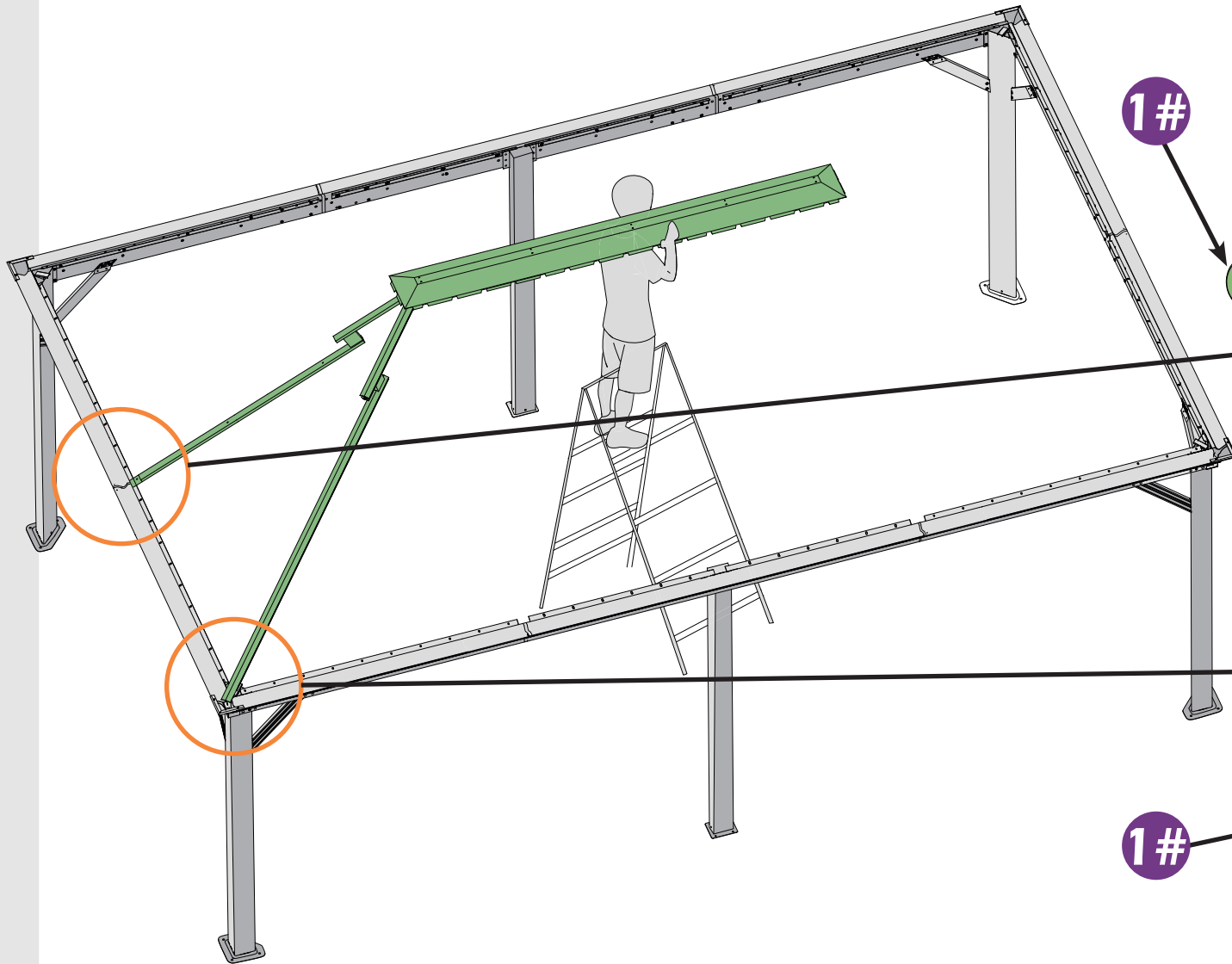
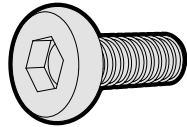

STEP 2

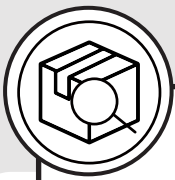

M × 3



1# × 9

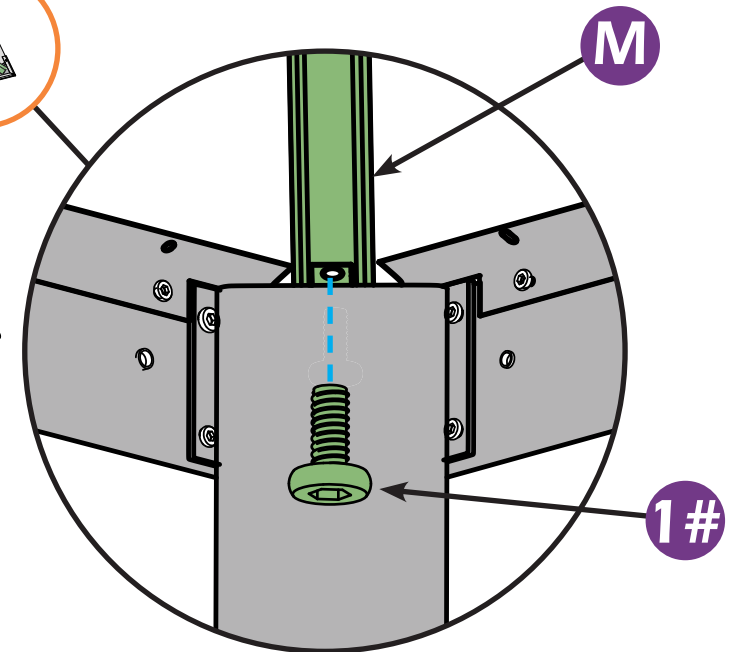
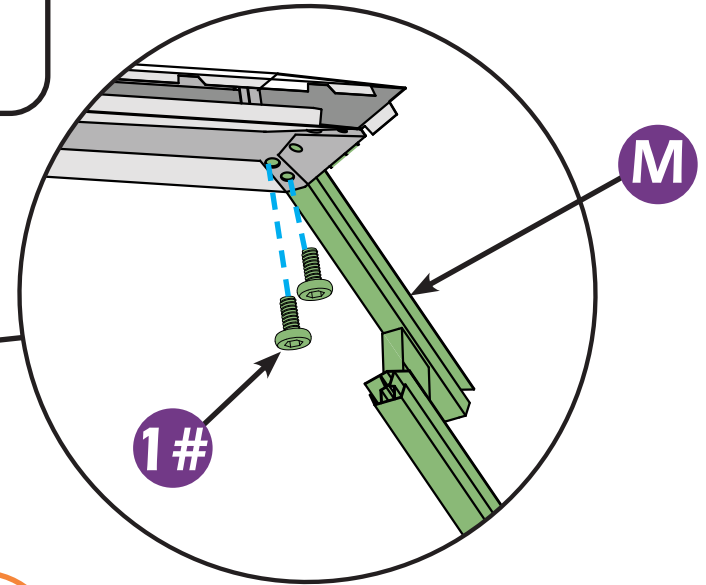
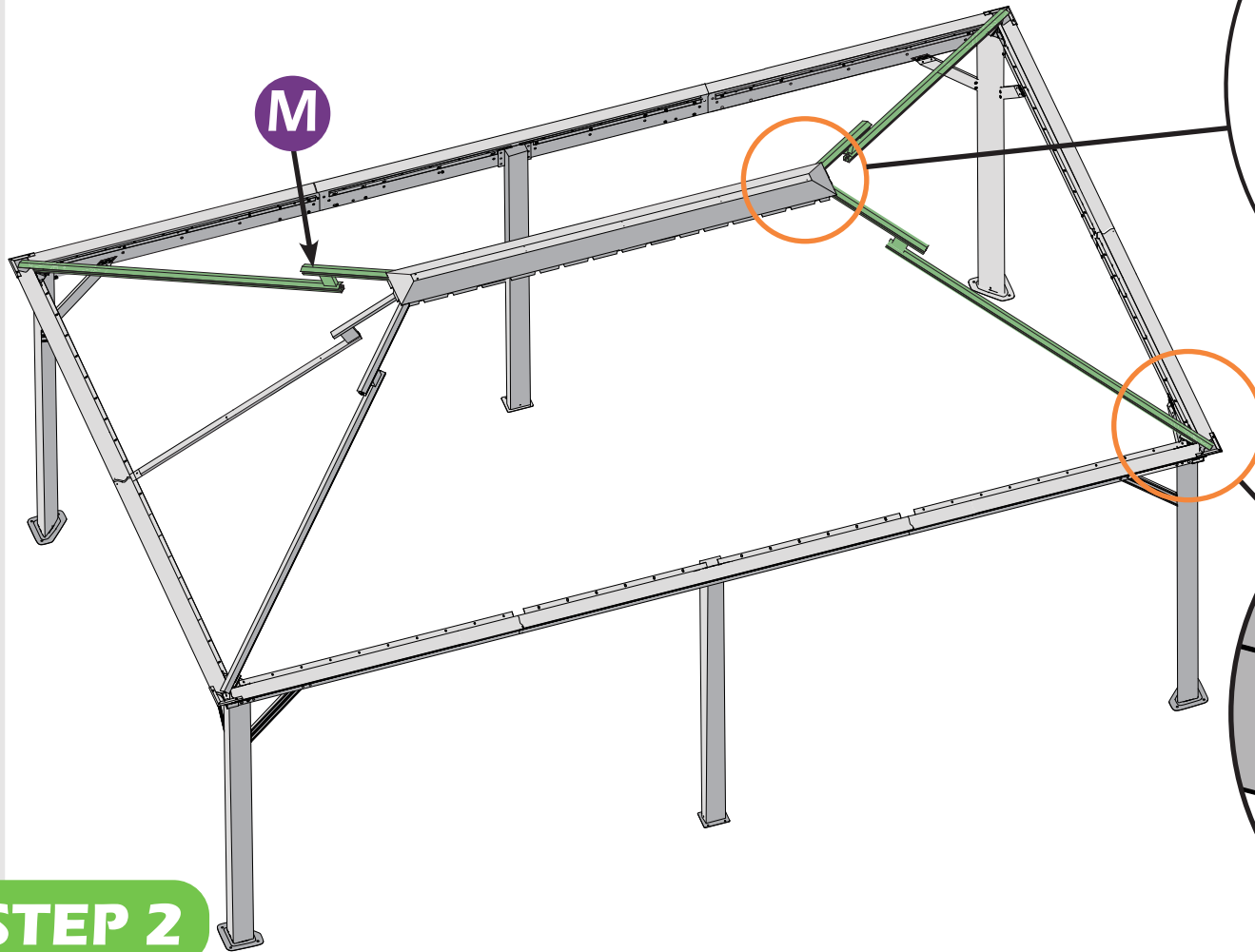
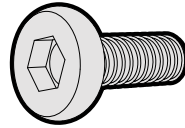

STEP 2

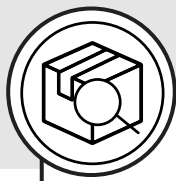

N × 1



1# × 3

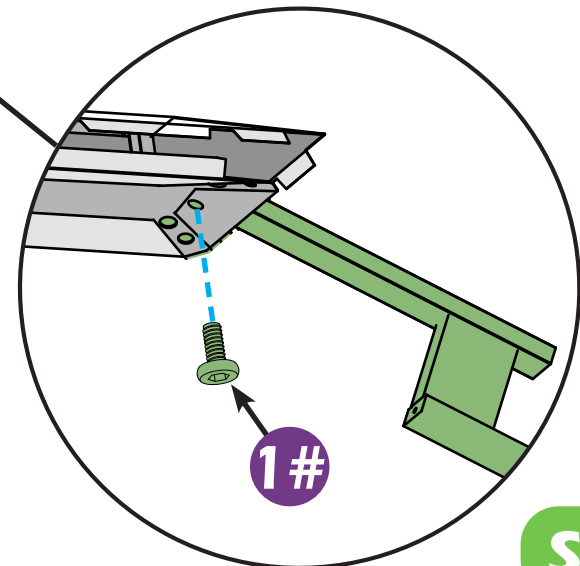
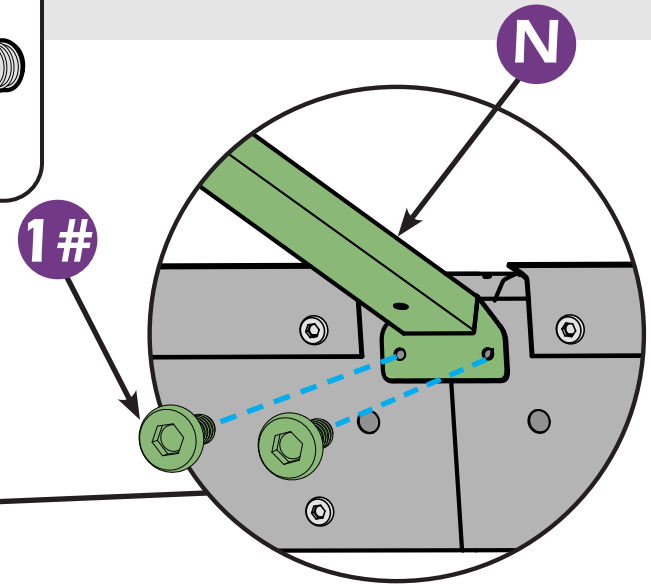
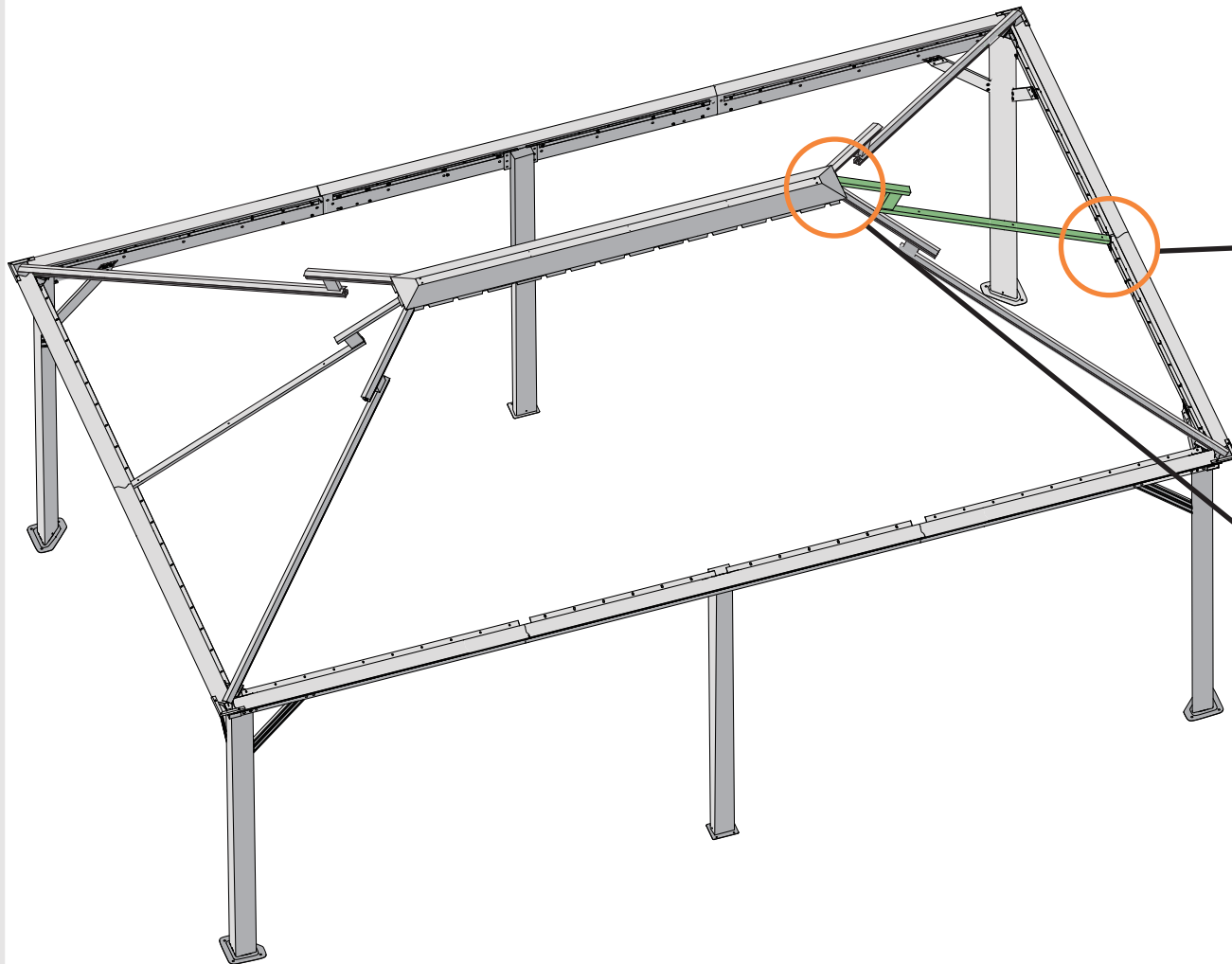
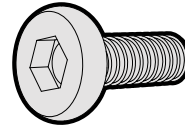

STEP 2

Check the the frame as pictures below shows.

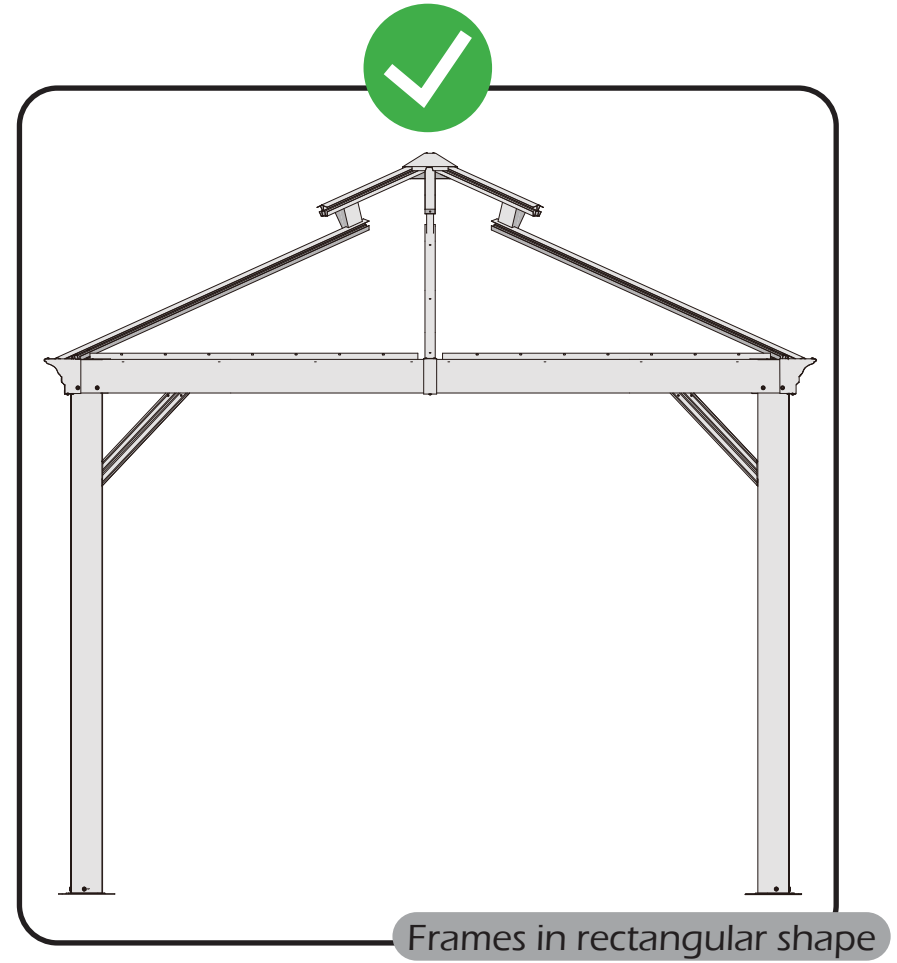
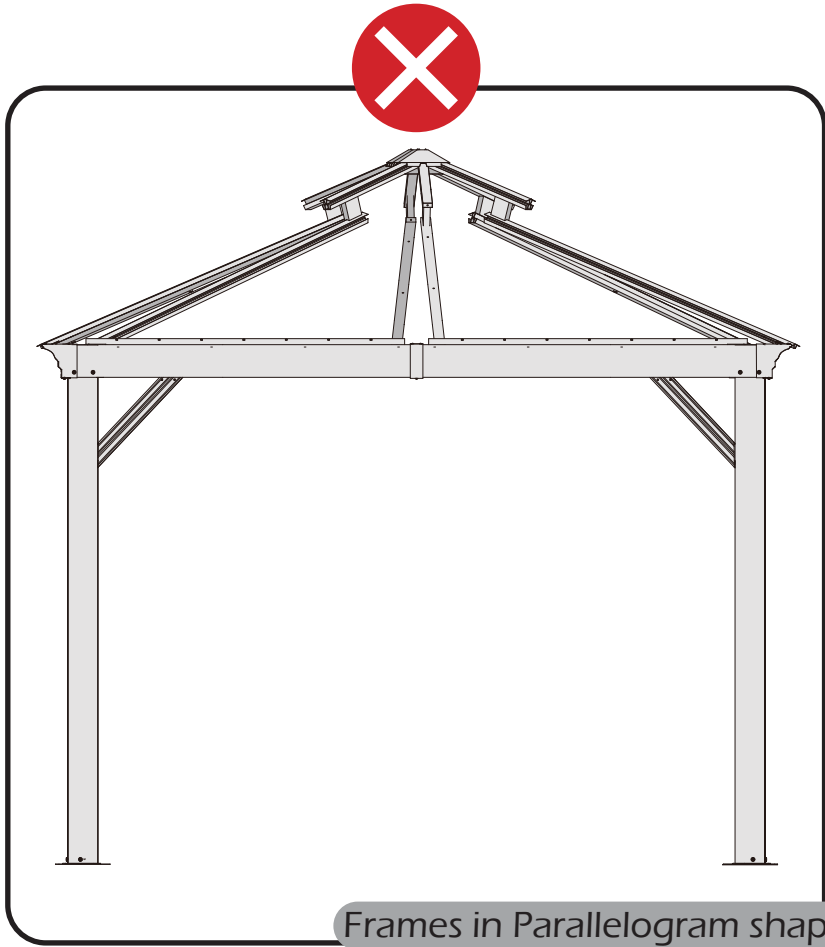

STEP 2

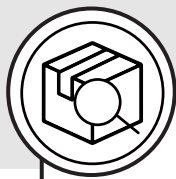

N1 × 4



1# × 18

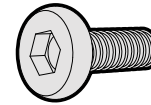

N2 × 2

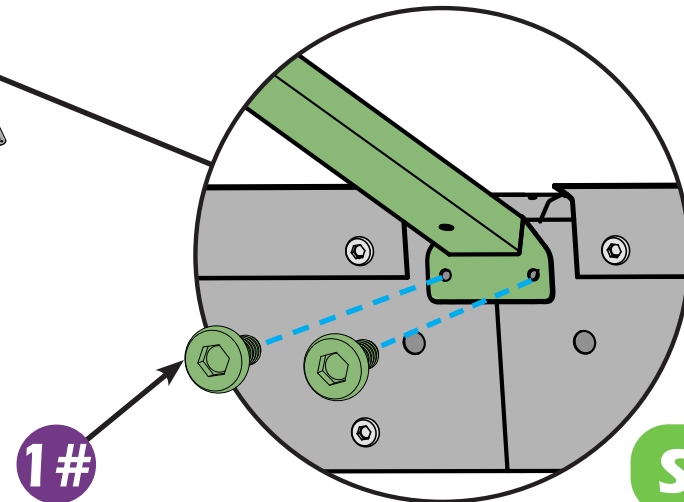
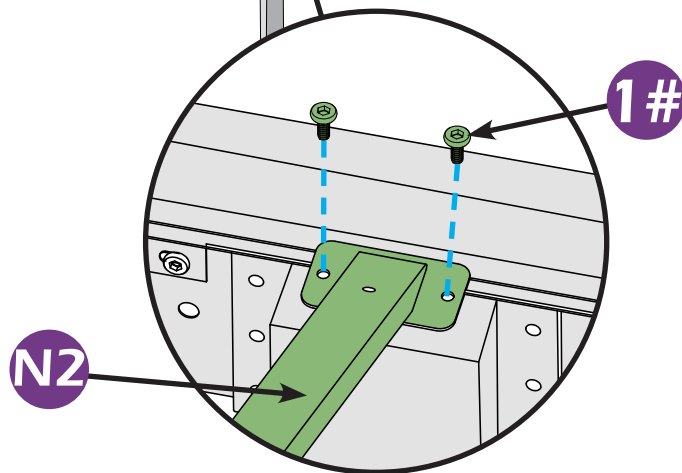
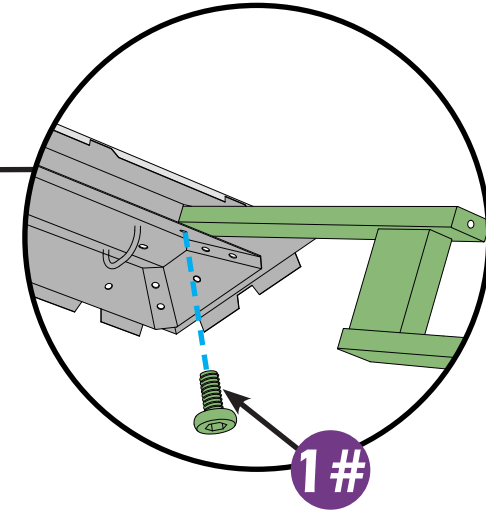
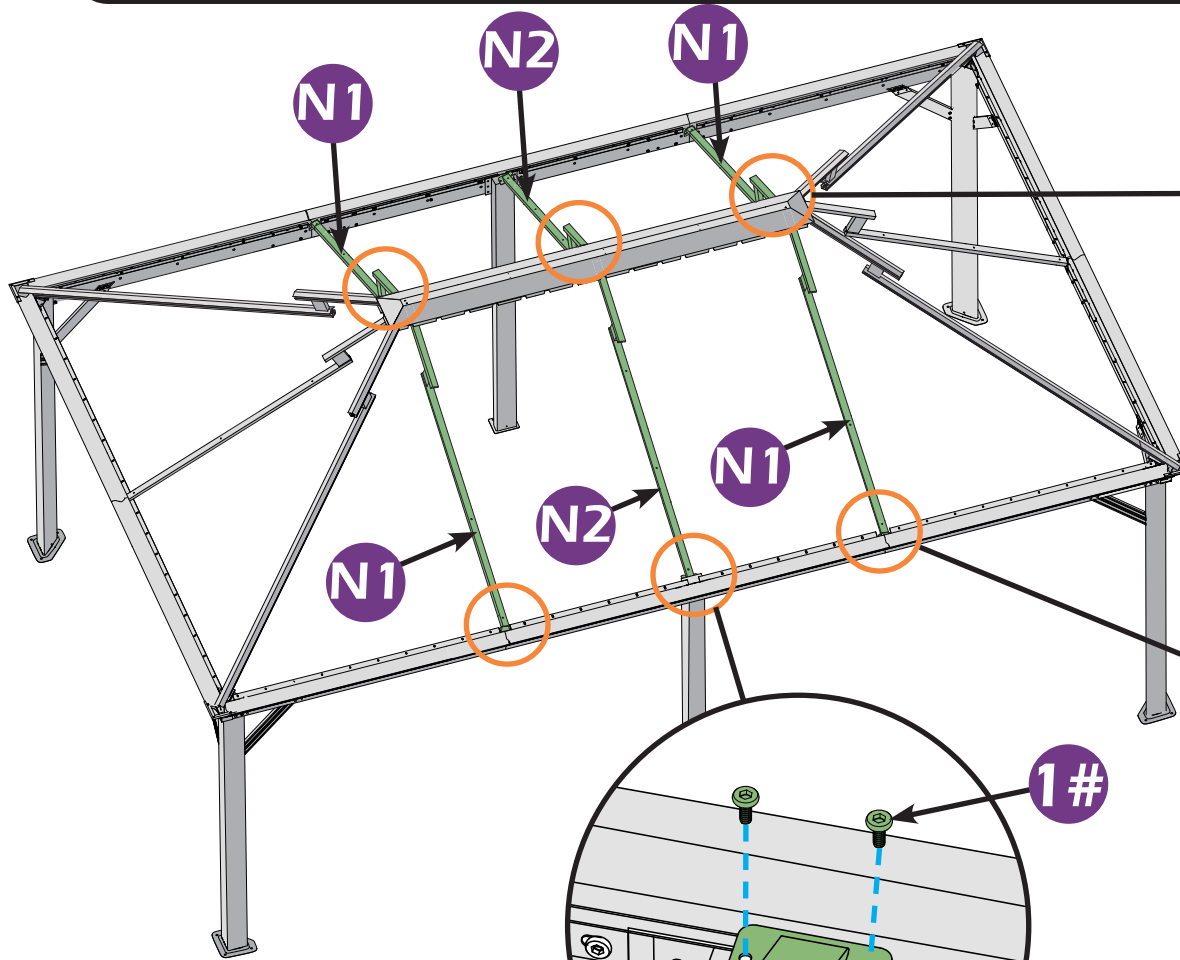
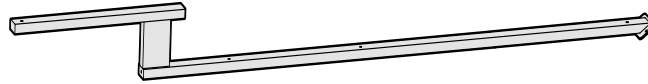

STEP 2