

11'×16' Aluminum Retractable Pergola

ASSEMBLY MANUAL

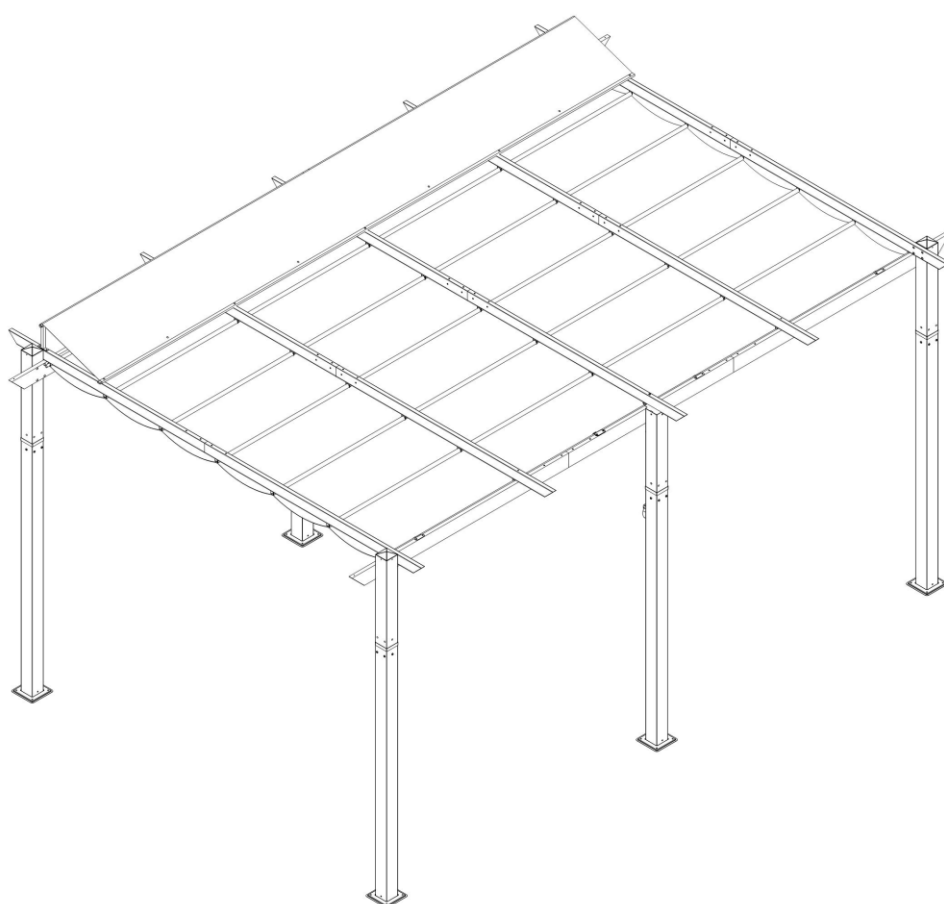

Missing part? Damaged? Contact us via email at

service@domioutdoorliving.com

www.domioutdoorliving.com

Pre-assembly



1. Two or more people are required for assembly.



2. You will need one or more stepladders.



3. Wearing protective gloves is recommended.



4. You may need a safety hat.



5. Please use a Phillips screw driver.



6. For ease of construction, you may need a drill.













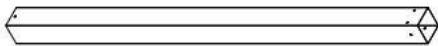
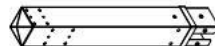

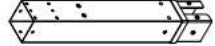

7. You may need a safety goggle.

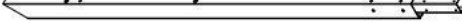











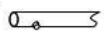



















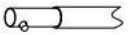
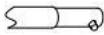

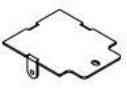

8. Do not fully tighten screws prior to complete assembly.

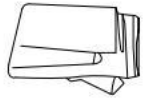
Warning & Attention







- Try to assemble this product on the flat ground, otherwise it is difficult to carry out;
- It would be much easier to assemble the product with three or more people;
- After assembly, please check whether all screws are tightened, to prevent parts from falling apart.

	<p>L=90x90x1760mm</p>  <p>(A) 6x</p>	<p>L=90x90x720mm</p>  <p>(A1) 2x</p>
	<p>L=90x90x720mm</p>  <p>(A2) 2x</p>	<p>L=90x90x650mm</p>  <p>(A3) 2x</p>
	<p>L=70x27x1755mm</p>  <p>(C) 1x</p>	<p>L=70x27x1750mm</p>  <p>(C1) 1x</p>
	<p>L=70x27x1755mm</p>  <p>(C2) 1x</p>	<p>L=70x27x1750mm</p>  <p>(C3) 1x</p>
	<p>L=70x27x1755mm</p>  <p>(D) 3x</p>	<p>L=70x27x1750mm</p>  <p>(D1) 3x</p>
	<p>L=100x25x1730mm</p>  <p>(E) 1x</p>	<p>L=100x25x1750mm</p>  <p>(E1) 1x</p>
	<p>L=100x25x1750mm</p>  <p>(E2) 1x</p>	<p>L=100x25x1730mm</p>  <p>(F) 1x</p>
	<p>L=100x25x1750mm</p>  <p>(F1) 1x</p>	<p>L=100x25x1750mm</p>  <p>(F2) 1x</p>
2		

Part list



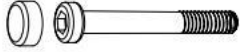

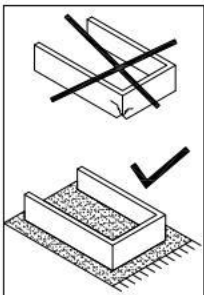

<p>L=Ø16x1507mm </p>  <p>(G) 2x</p>	<p>L=Ø16x1507mm </p>  <p>(G1) 2x</p>		
<p>L=Ø16x1380mm </p>  <p>(G2) 1x</p>	<p>L=Ø16x1380mm </p>  <p>(G3) 1x</p>		
<p>L=20x10x1113mm  </p>  <p>(H) 1x</p>	<p>L=20x10x1111mm  </p>  <p>(H1) 2x</p>		
<p>L=20x10x1113mm  </p>  <p>(H2) 1x</p>	<p>L=Ø19x1146mm  </p>  <p>(J) 12x</p>		
<p>L=Ø19x1146mm  </p>  <p>(J1) 6x</p>	 <p>(K) 1x</p>		
 <p>(B) 6x</p>	 <p>(B1) 2x</p>	 <p>(L) 1x</p>	 <p>(M) 1x</p>
 <p>(M1) 1x</p>	 <p>(N) 5x</p>	 <p>(P) 12x</p>	 <p>(Q) 4x</p>
 <p>(R) 1x</p>	 <p>(S) 1x</p>	 <p>(S1) 17x</p>	 <p>(S2) 12x</p>

Part list

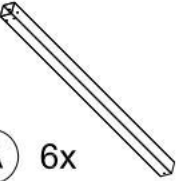
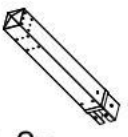
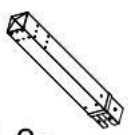
 T 40x	 M6x16 1 119x	 M6x16 2 40x	 M6x28 3 9x
 M6x85 4 6x	 S4 5 1x		









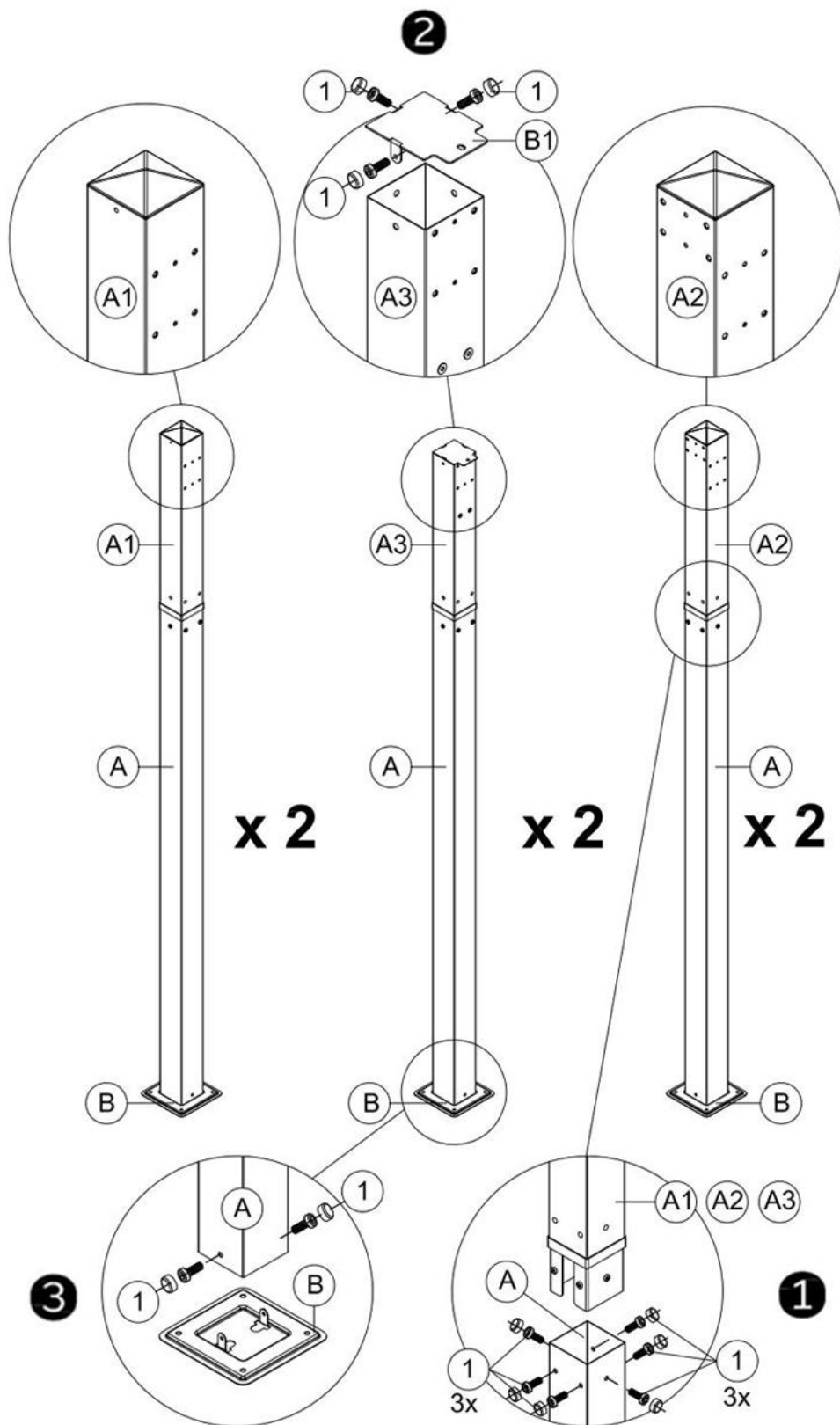

4



(A) 6x

(A1) 2x

(A2) 2x

(A3) 2x

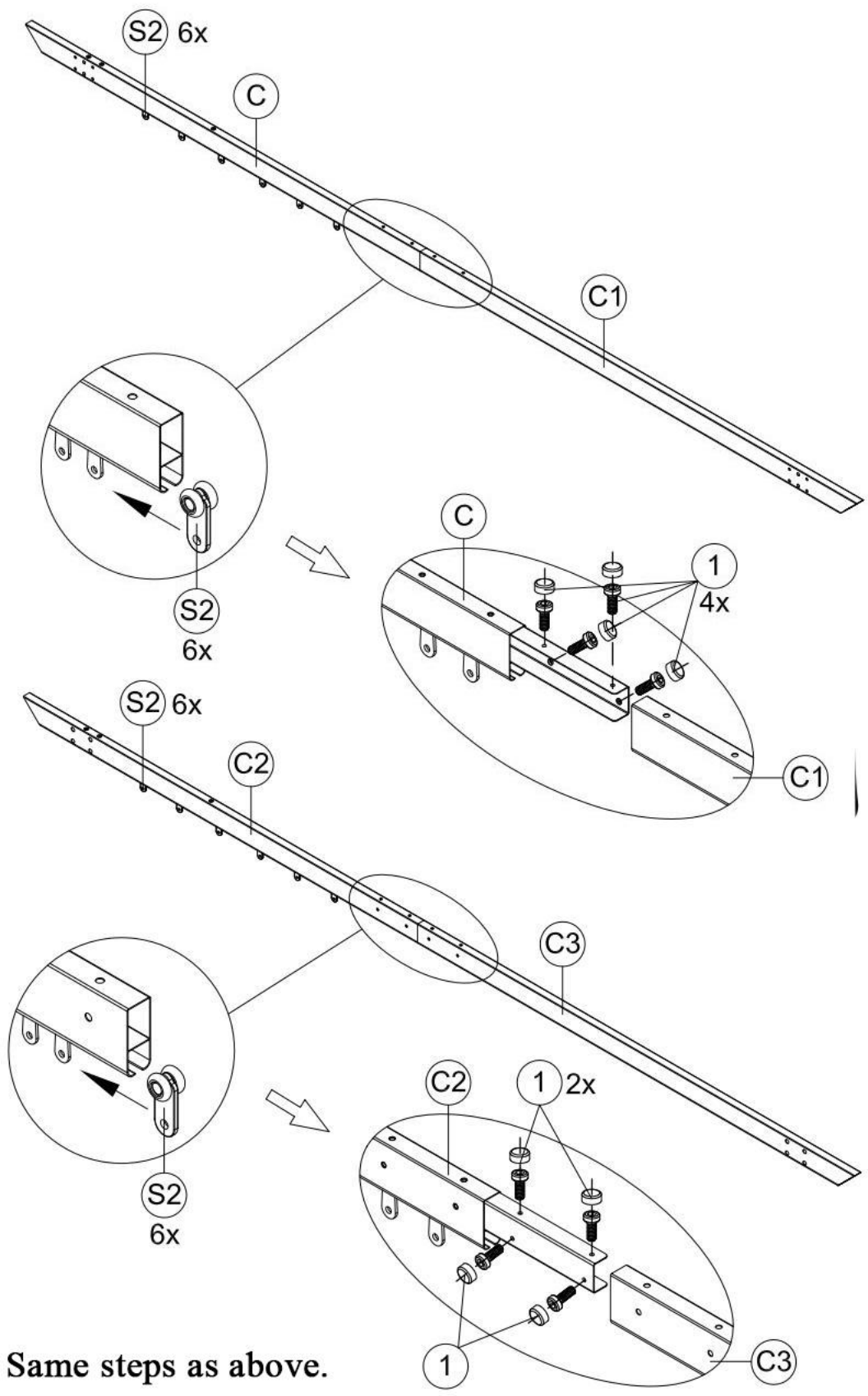
(B) 6x

(B1) 2x

(1) 54x M6x16

(5) 1x S4
5

- Step 1:**
- 1** Connect part A and part A1(A2, A3) with screws 1# as shown.
 - 2** Connect part A3 and part B1 with screws 1# as shown.
 - 3** Connect part A and part B with screws 1# as shown.







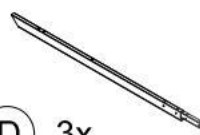
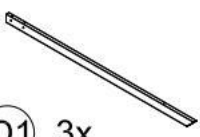

-  C 1x
-  C1 1x
-  C2 1x
-  C3 1x
-  S2 12x
-  1 8x M6x16
-  S4
-  5 1x
- 6**

Step 2: First of all, put six sliders(S2) into part C or part C1.
Then connect part C and part C1 with screws 1# as shown.



Same steps as above.



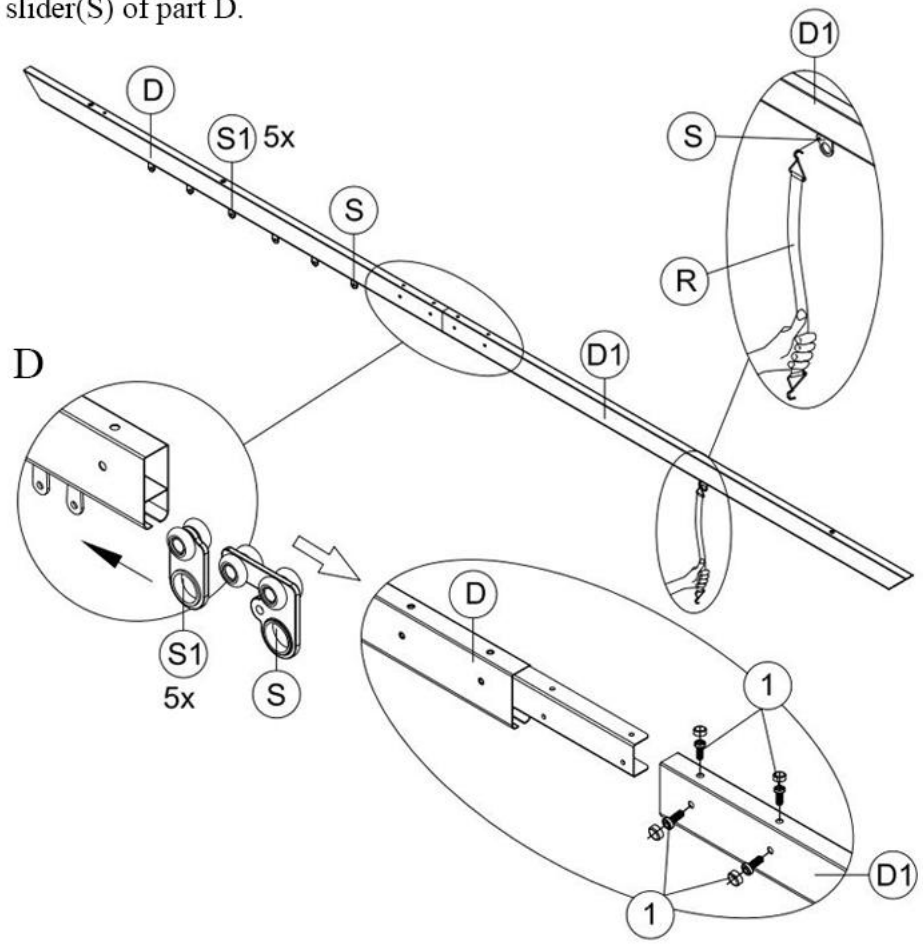

-  (D) 3x
-  (D1) 3x
-  (R) 1x
-  (S) 1x
-  (S1) 17x
-  (1) 12x
M6x16
-  (S4) 1x
-  (5) 1x
-
- 7**

Step 3: First of all, put five sliders(S1) and one slider(S) in turn into part D. Then connect part D and part D1 with screws 1# as shown. And hang part R on the outside slider(S) of part D.

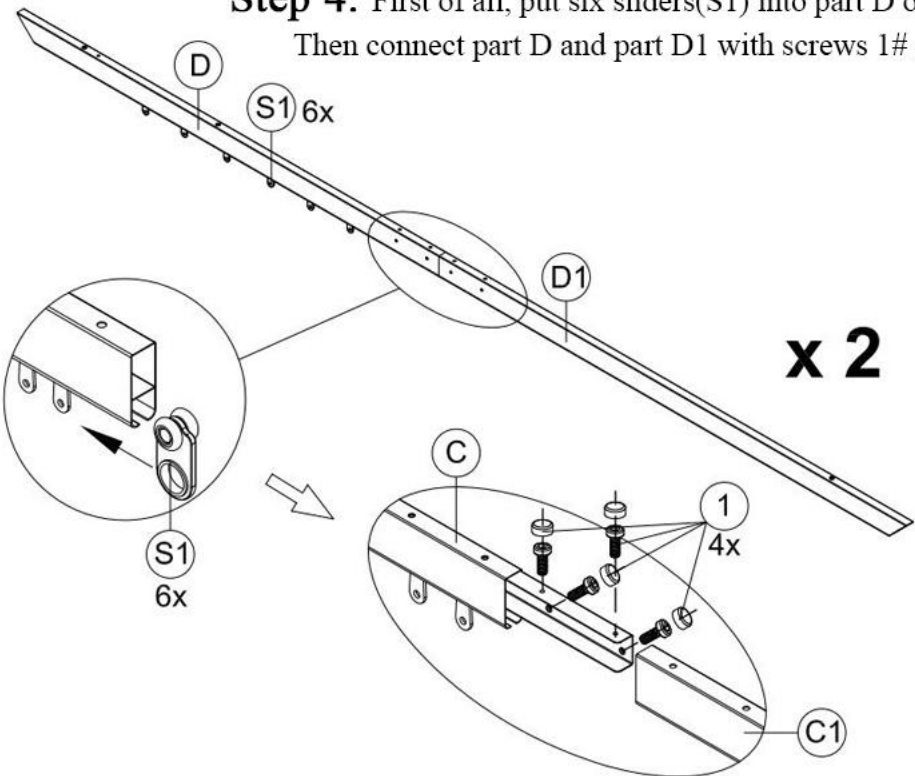

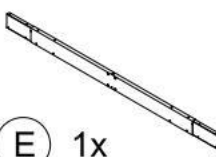
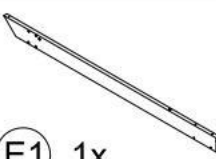
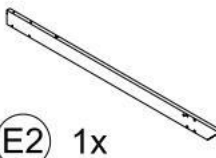
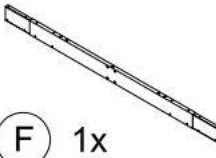
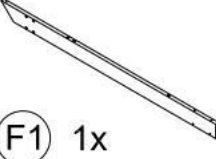
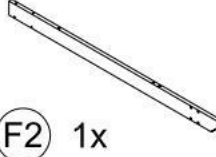
Step 4: First of all, put six sliders(S1) into part D or part D1. Then connect part D and part D1 with screws 1# as shown.



	E 1x
	E1 1x
	E2 1x
	F 1x
	F1 1x
	F2 1x
	Q 4x
	1 24x M6x16
	5 1x S4
8	

Step 5: Firstly, connect part E1 and part E with screws 1#.
 Secondly, connect part E and part E2 with screws 1#.
 Thirdly, install the part Q with screws 1# on the part E2(E, E1) as shown.

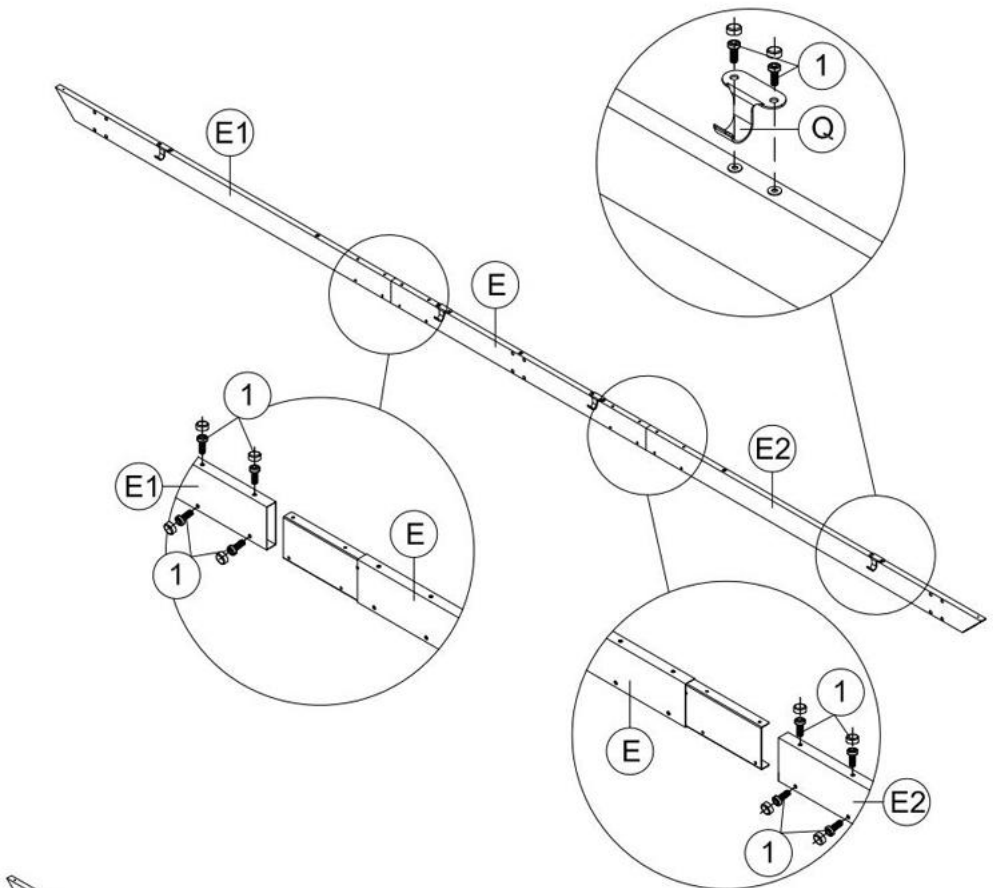

Step 6: Firstly, connect part F1 and part F with screws 1#.
 Then connect part F and part F2 with screws 1#.

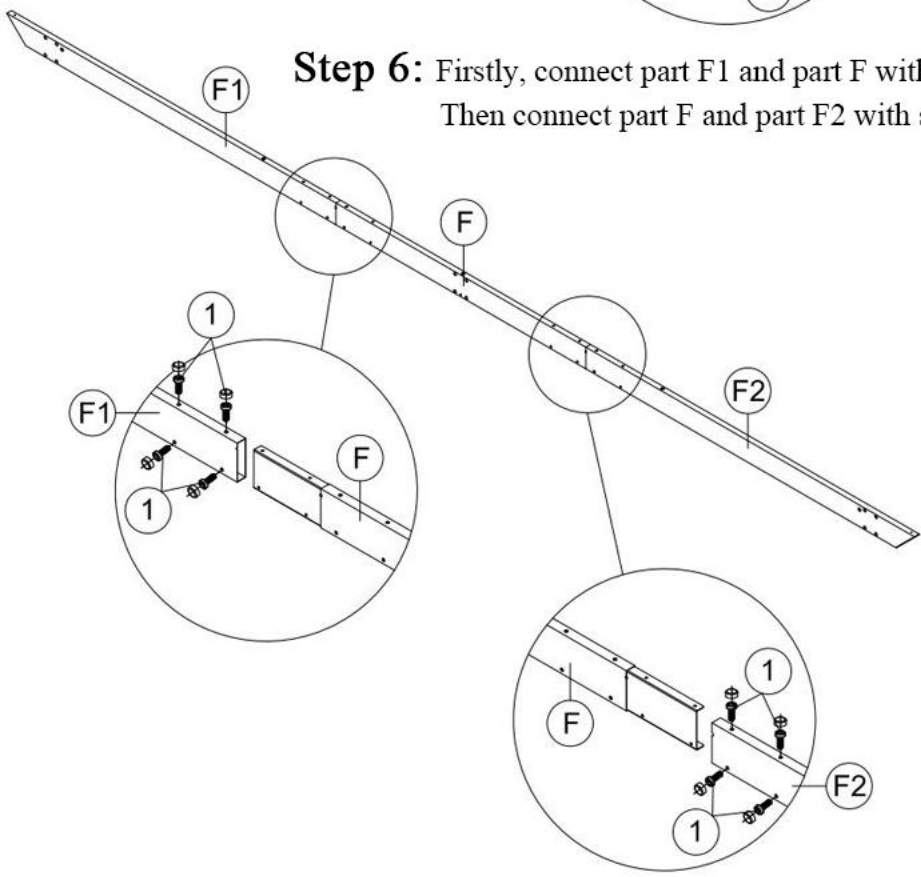



T 24x



M6x16

2 24x



5 1x

Step 7: Connect part A1 and part F1 with screws 2#, and put part T on the holes as shown. Then connect part A3 and part F, part A2 and part F2, part A2 and part E2, part A3 and part E, part A1 and part E1 the same way as above.

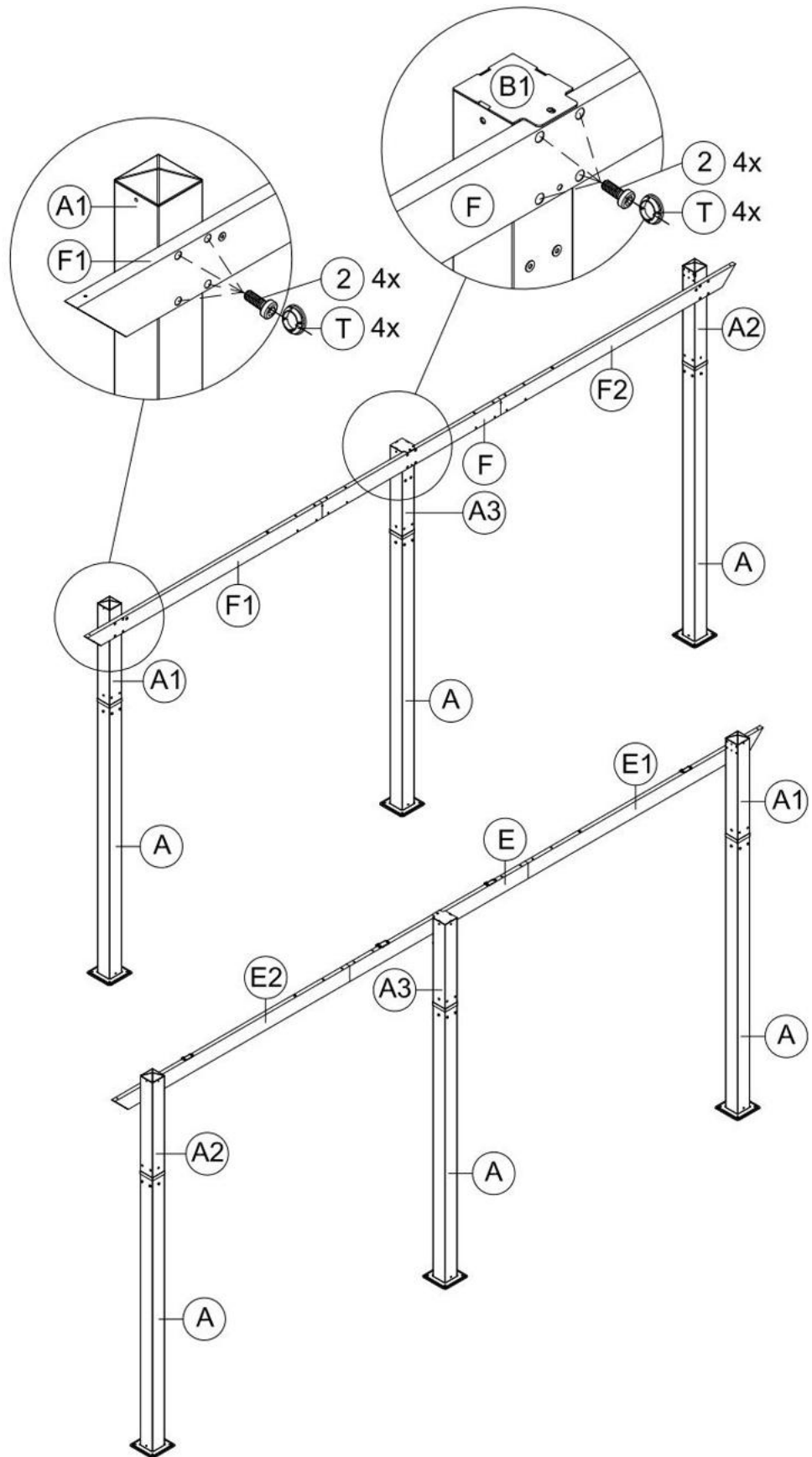



M6x85

4 3x









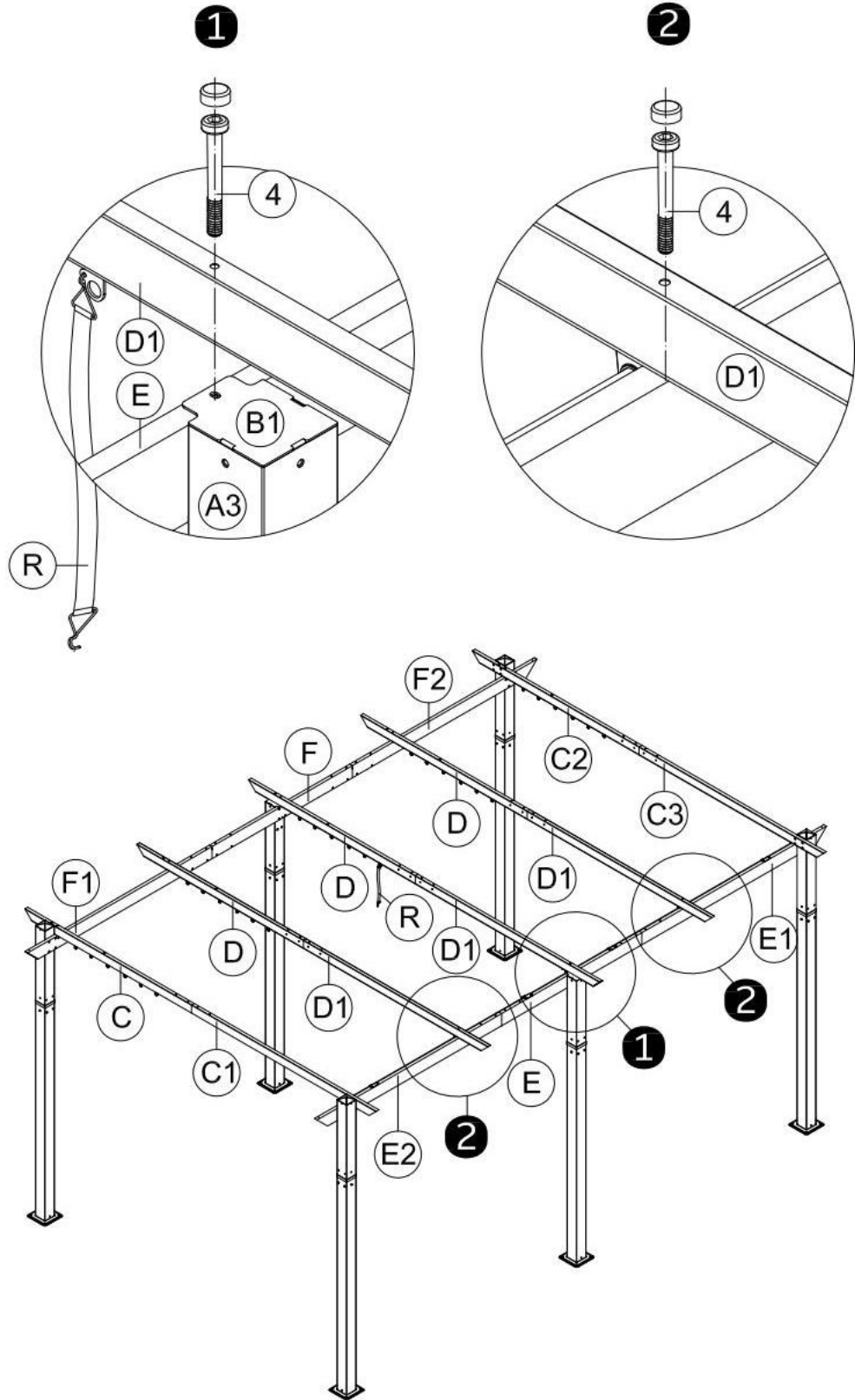

S4

5 1x

Step 9: ① Insert screw 4# into part D1 and part E as shown.

② Insert screw 4# into part D1 and part E1, part D1 and part E2 as shown.



-  **G** 2x
-  **G1** 1x
-  **H** 1x
-  **H1** 2x
-  **H2** 1x
-  **M1** 1x
-  **N** 5x

Step 10: Join the four sections(H, H1, H1, H2) together and insert them into part M1. Insert part G&part G2 into part M1 using part N as shown.

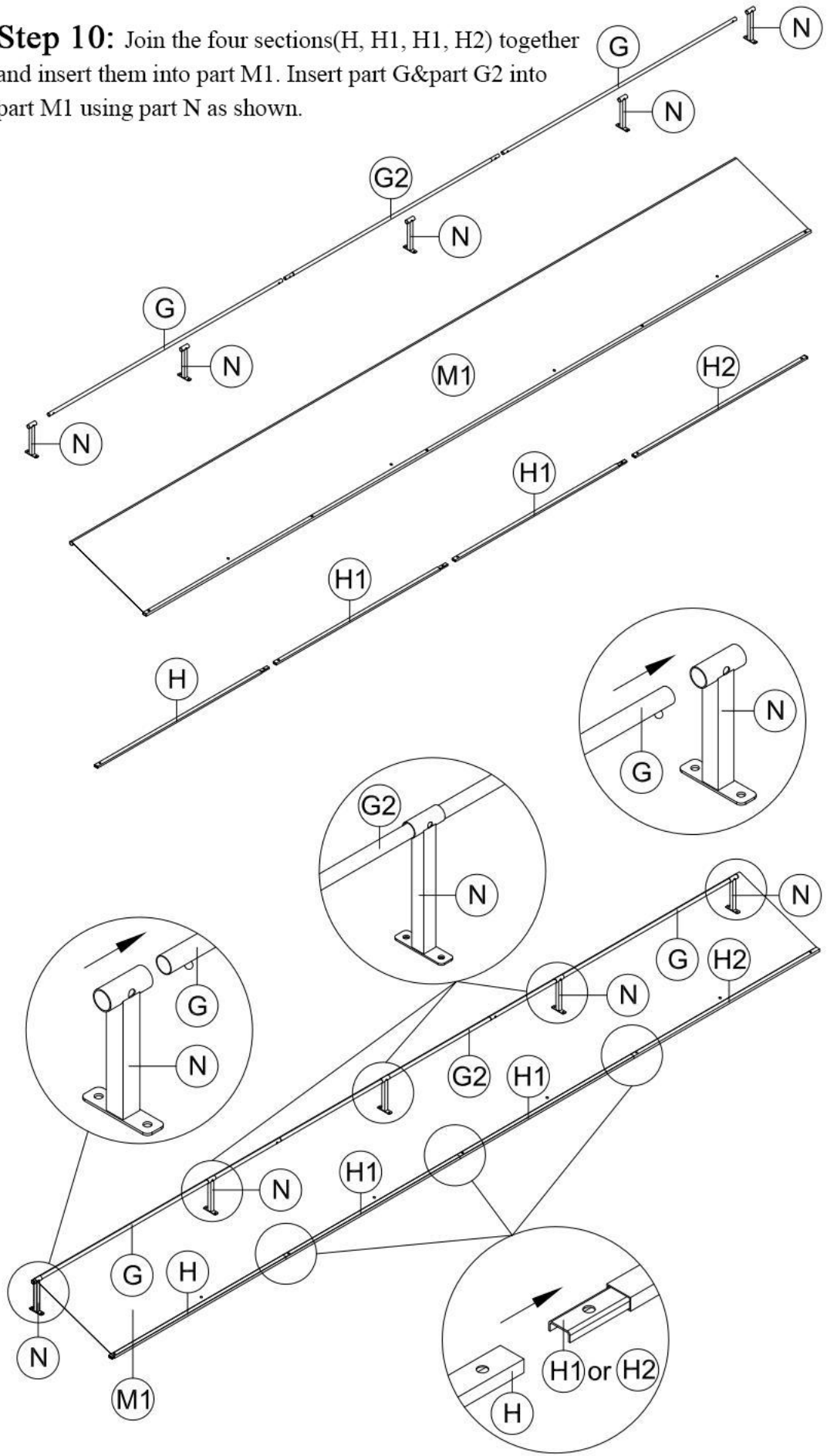



M6x16

1 7x



M6x28

3 5x



M6x85

4 3x



S4

5 1x

- Step 11:**
- 1 Connect part N and part A1(A2) with screws 1#.
 - 2 Connect part N and part D with screw 1# and screw 4#.
 - 3 Connect part H(H2) and part C(C2) with screw 3#.
 - 4 Connect part H1 and part D with screw 3#.

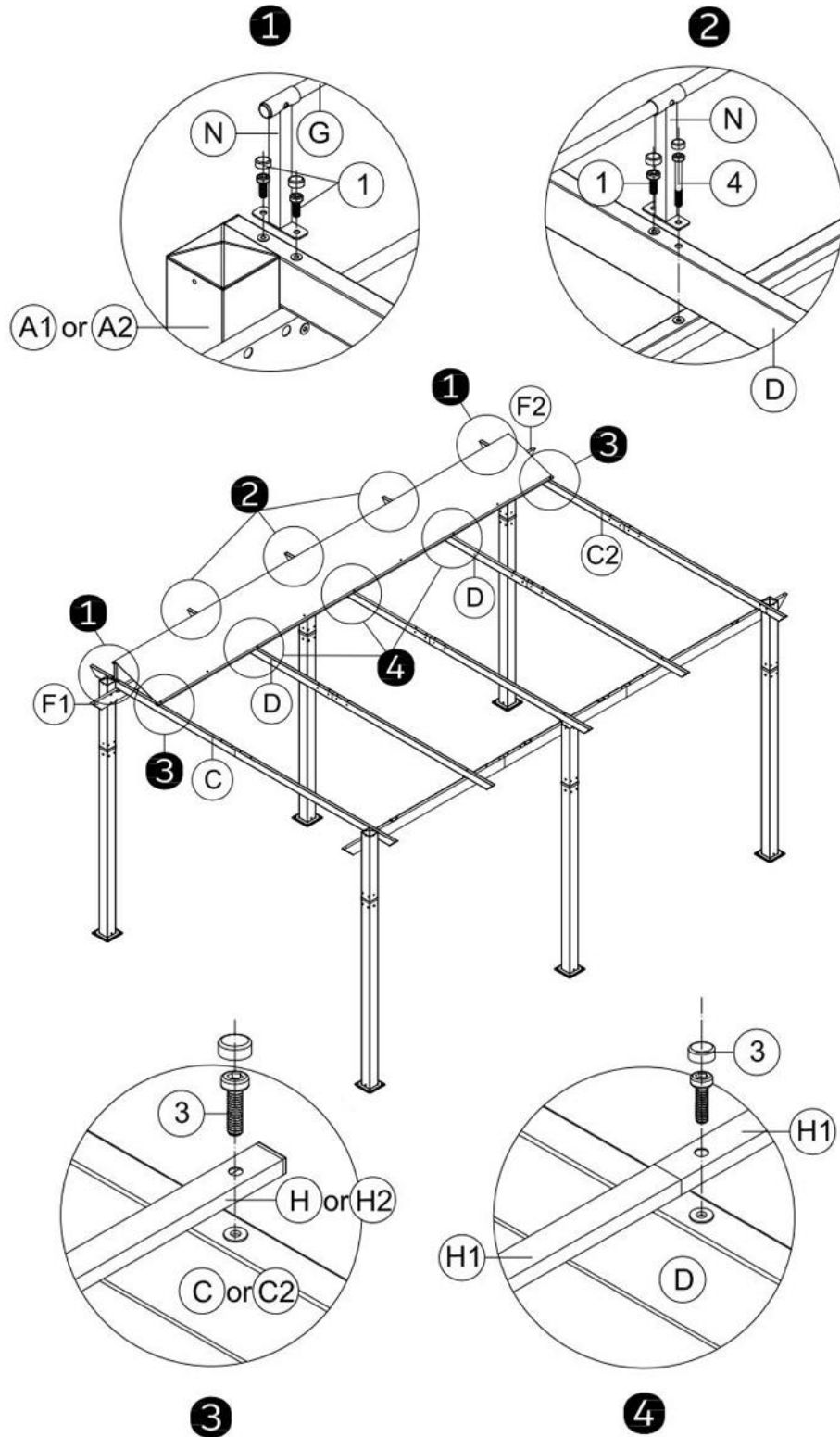

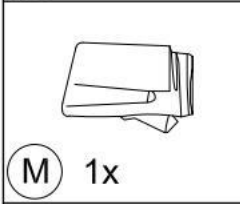
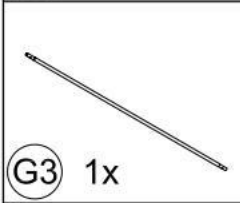
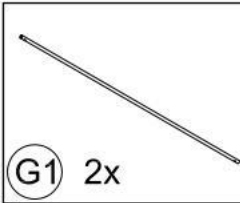

Step 12: Join part G1 and part G3 together.
Then insert them into part M.

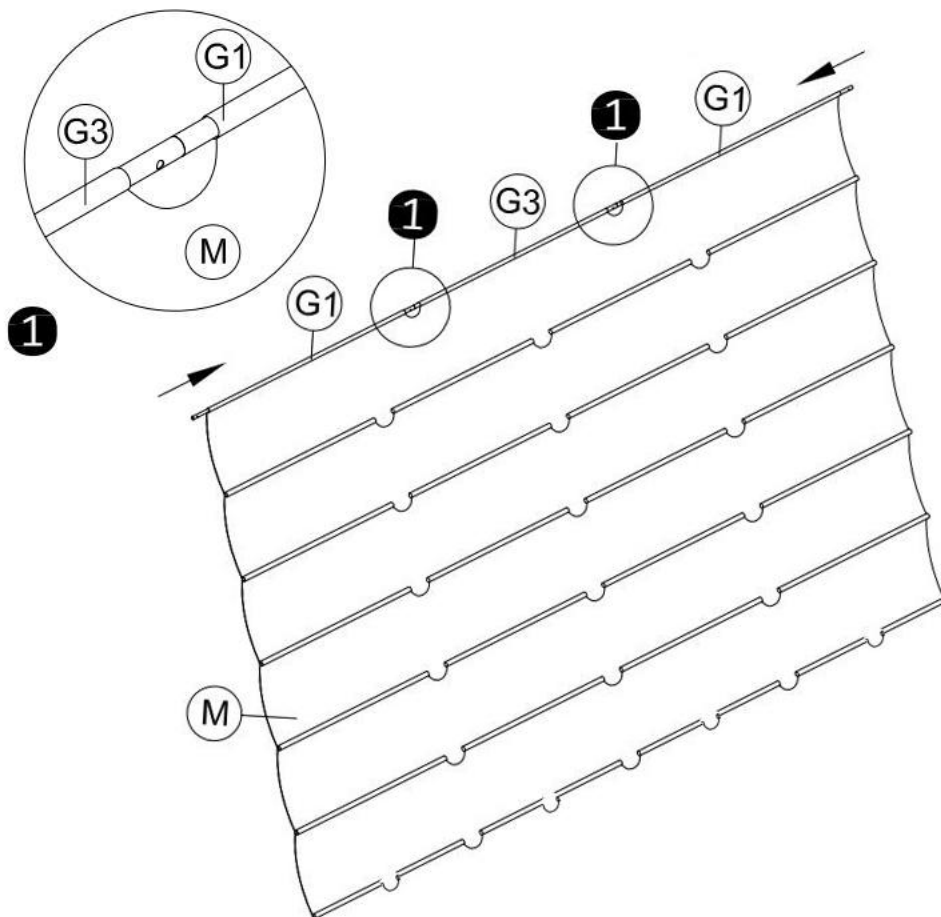
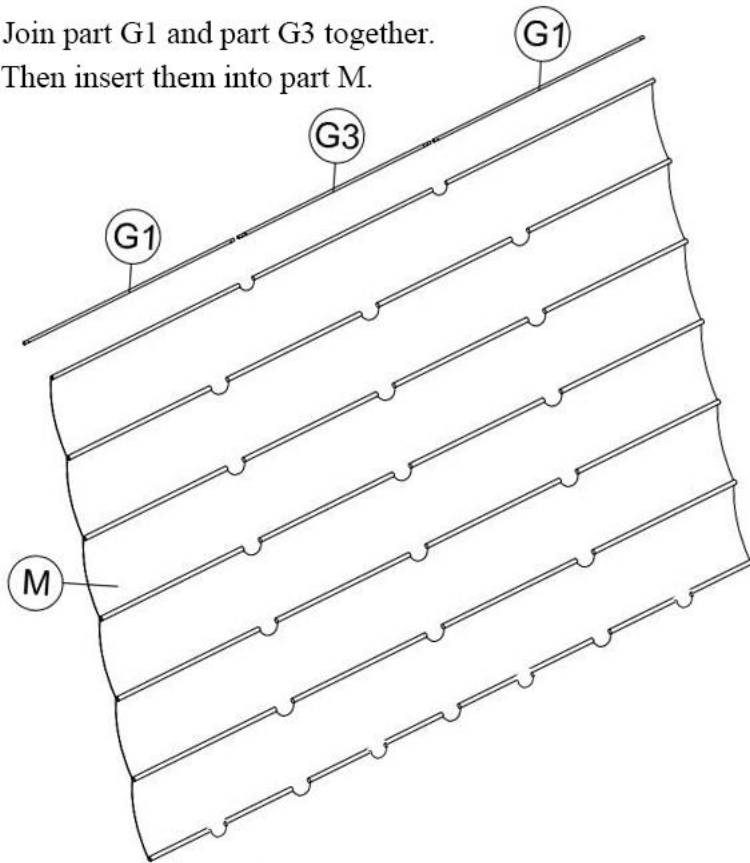



M6x28

3 4x



5 1x

Step 13: ① Insert screw 3# into part G1&part F1 as shown.

② Insert screw 3# into part G3 as shown.

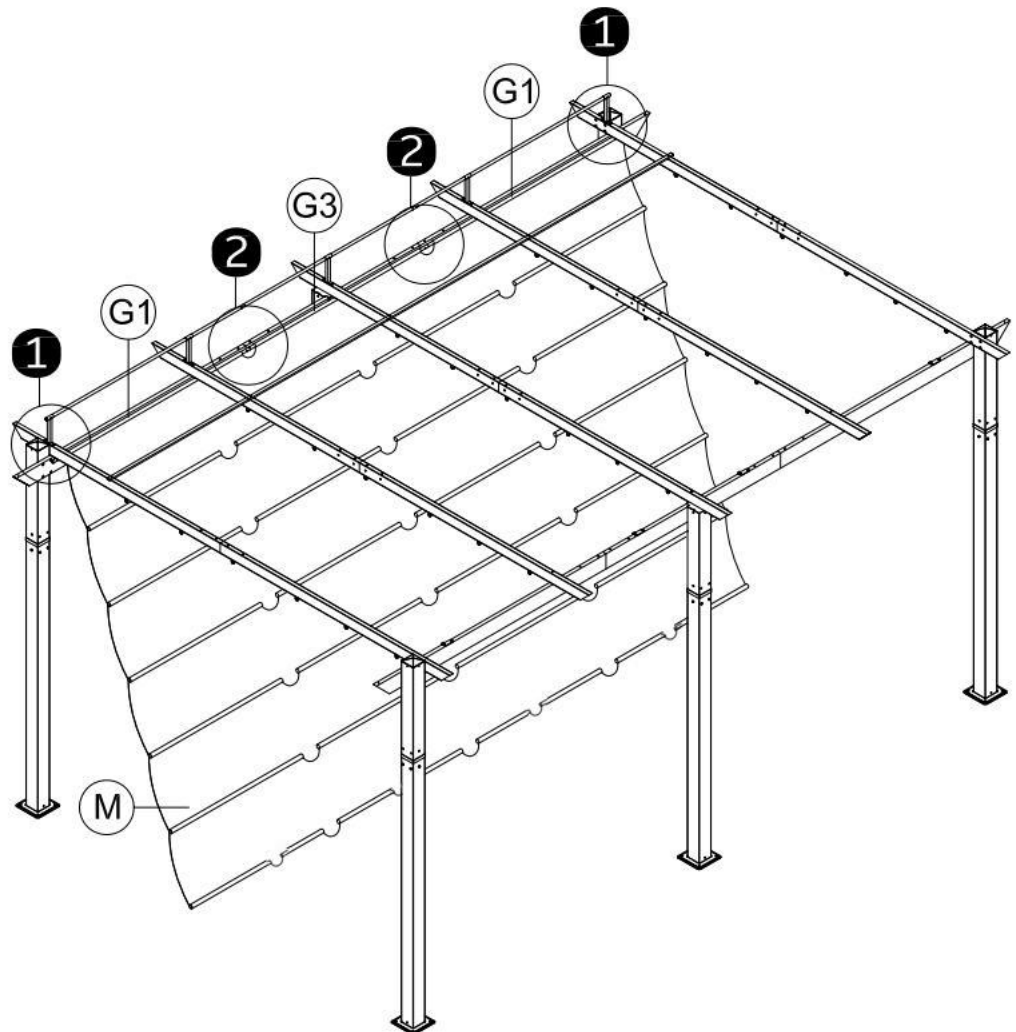
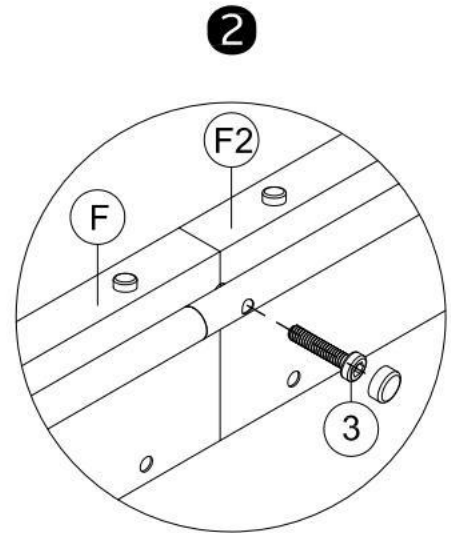
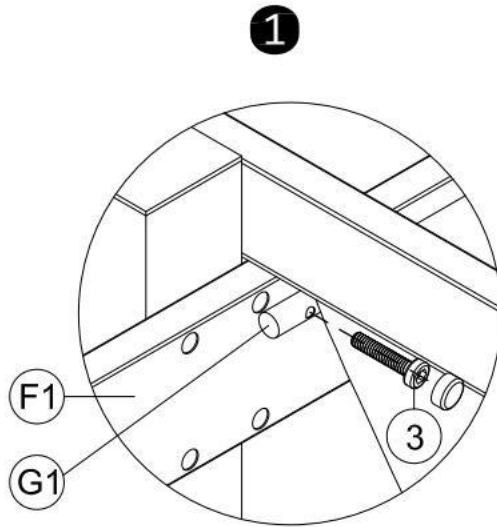

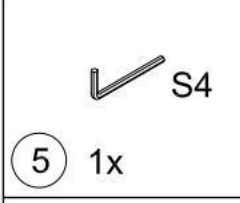
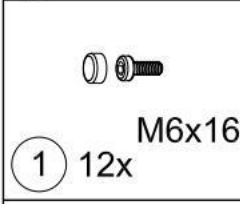
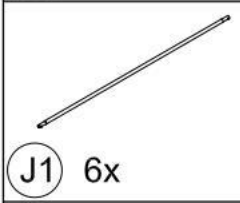
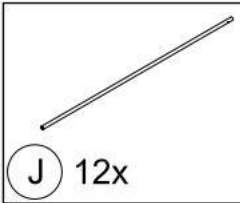



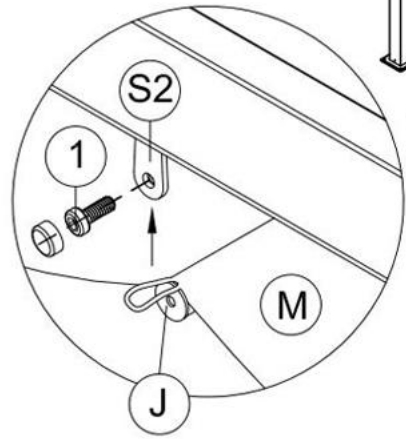
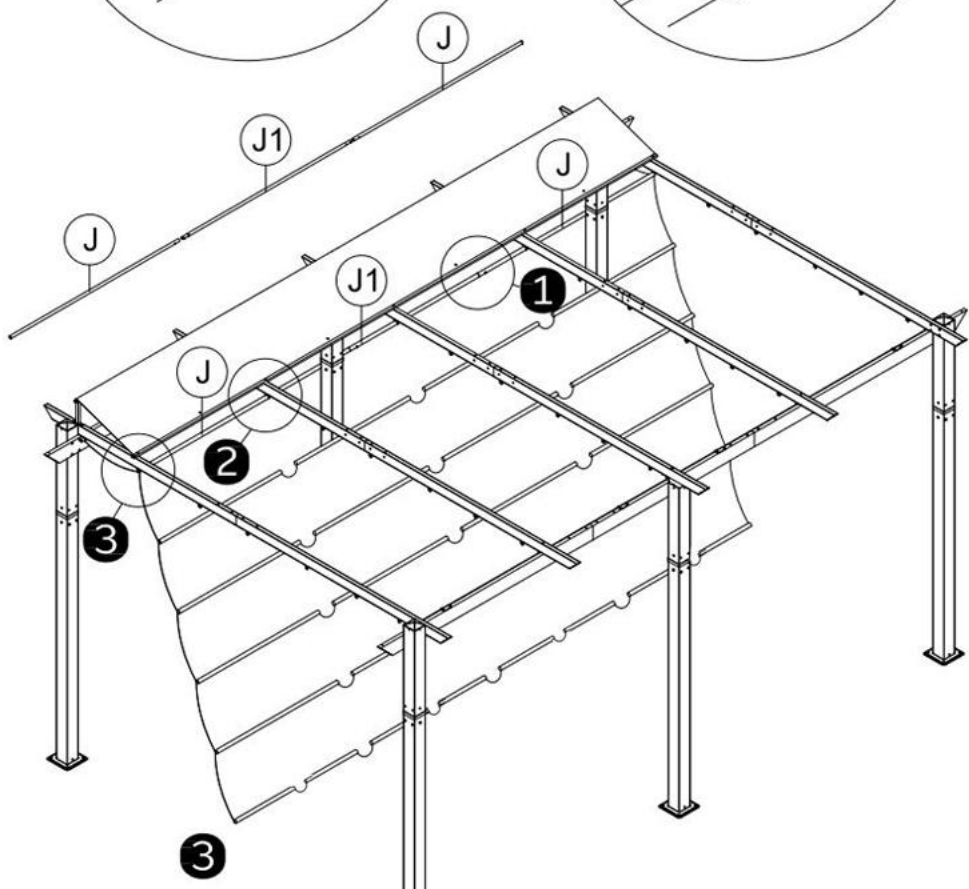
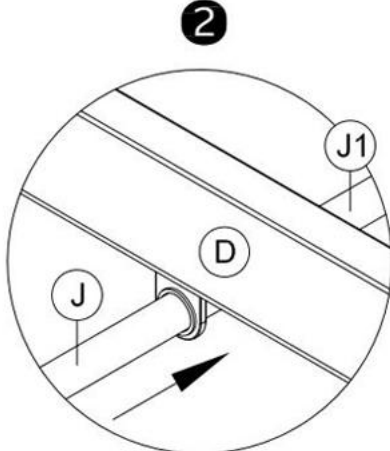
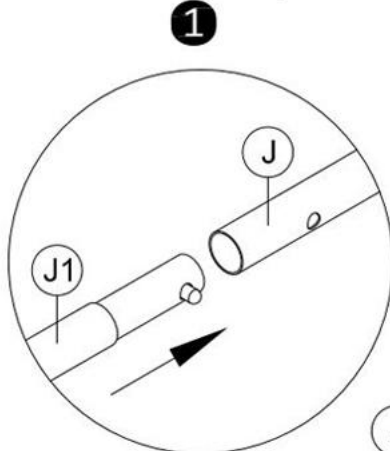

Step 14: Join the part J and part J1, and Insert them into the slider.
 (Pay attention to the snap buckle when you insert into the slider.)
 Then, Connect part J and part S2 with screws 1#.

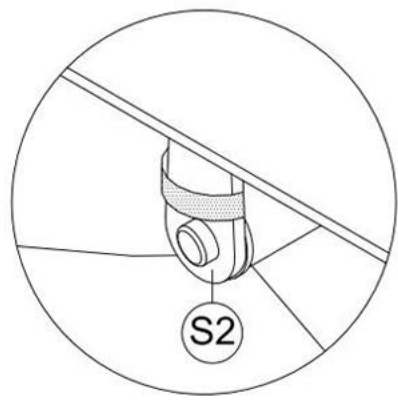

x 6



-  (K) 1x
-  (L) 1x
-  (1) 2x M6x16
-  (5) 1x S4

Step 15: **1** When the canopy is folded, hang the other end of string (part R) into the hole on the inside of beam (part F) to secure the top roof.
2 Connect part L and part A3 with screws 1#.

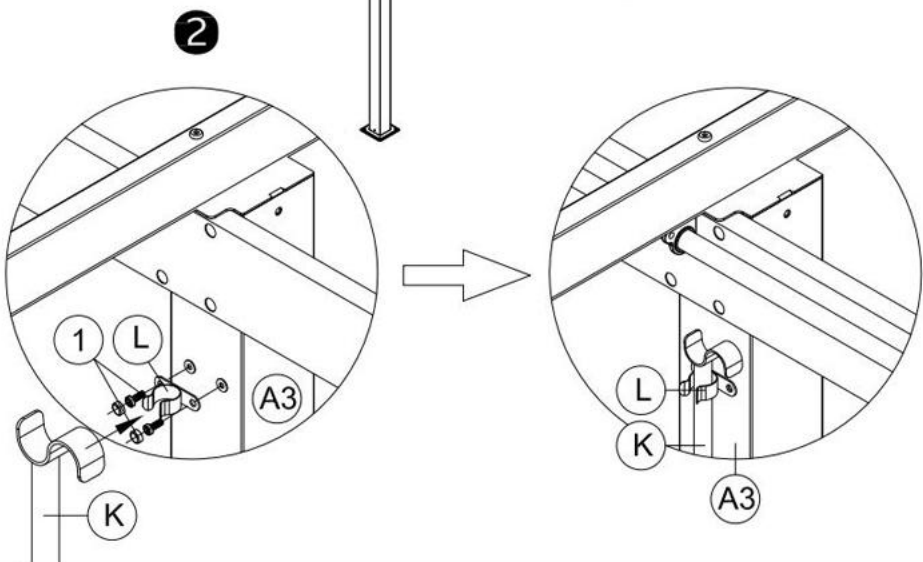
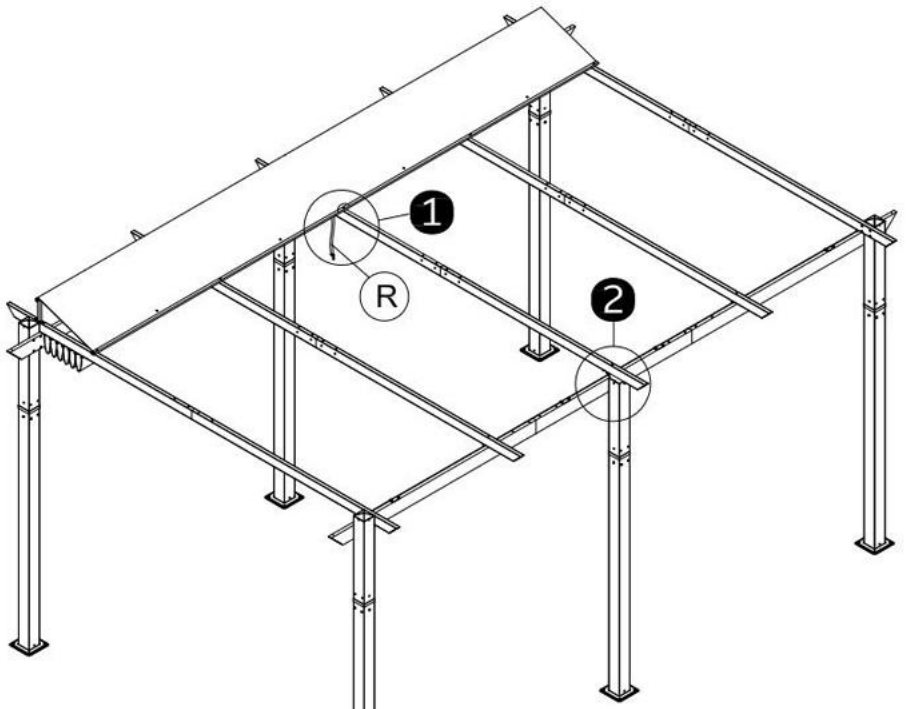
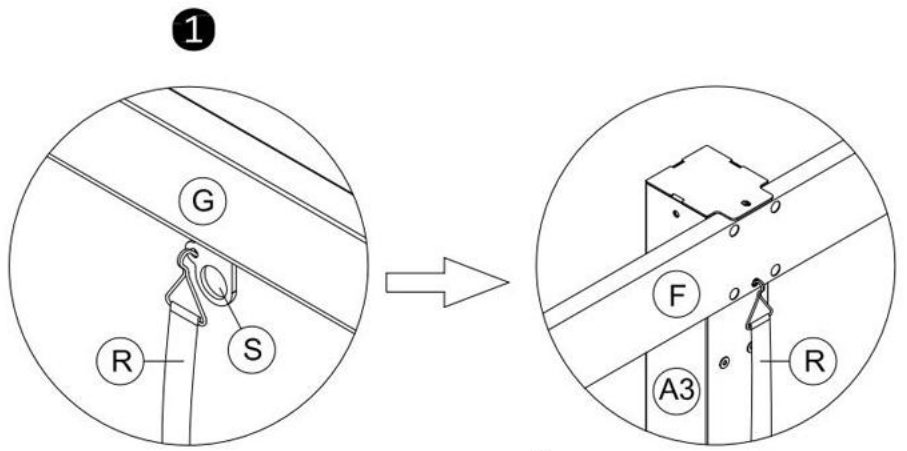

1

P 12x

Step 16: **1** When you want to close the canopy, you have to lift part J by using part K and put it on part Q.
2 Insert stakes (part P) through the hole of stand plate (part B) into the ground, to stabilize the tent.

