

ASSEMBLY INSTRUCTION

SRN-5804

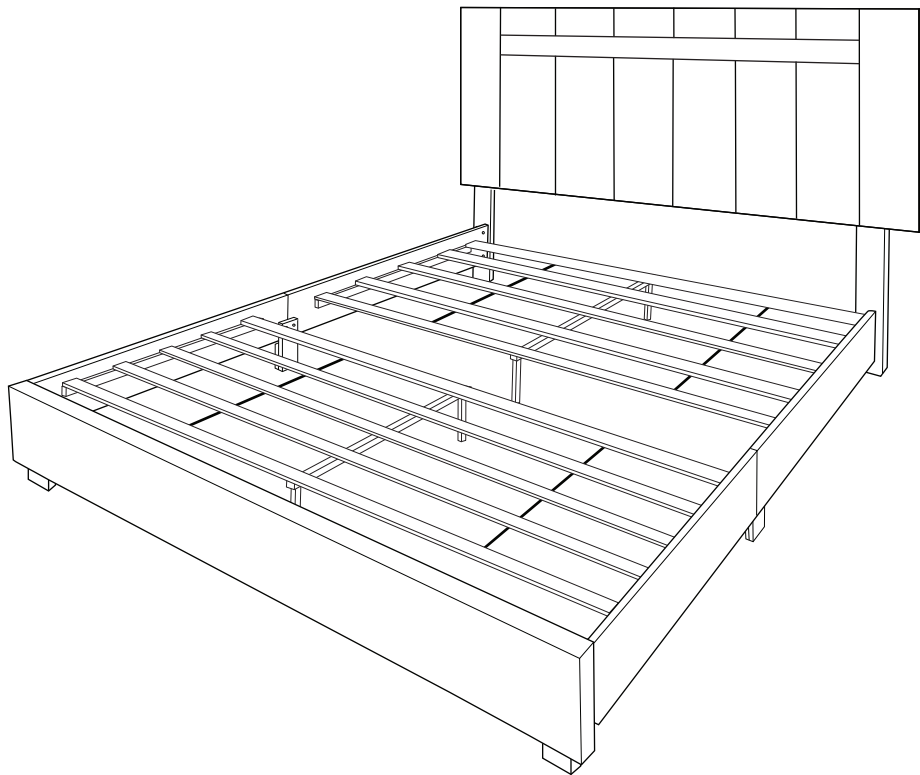

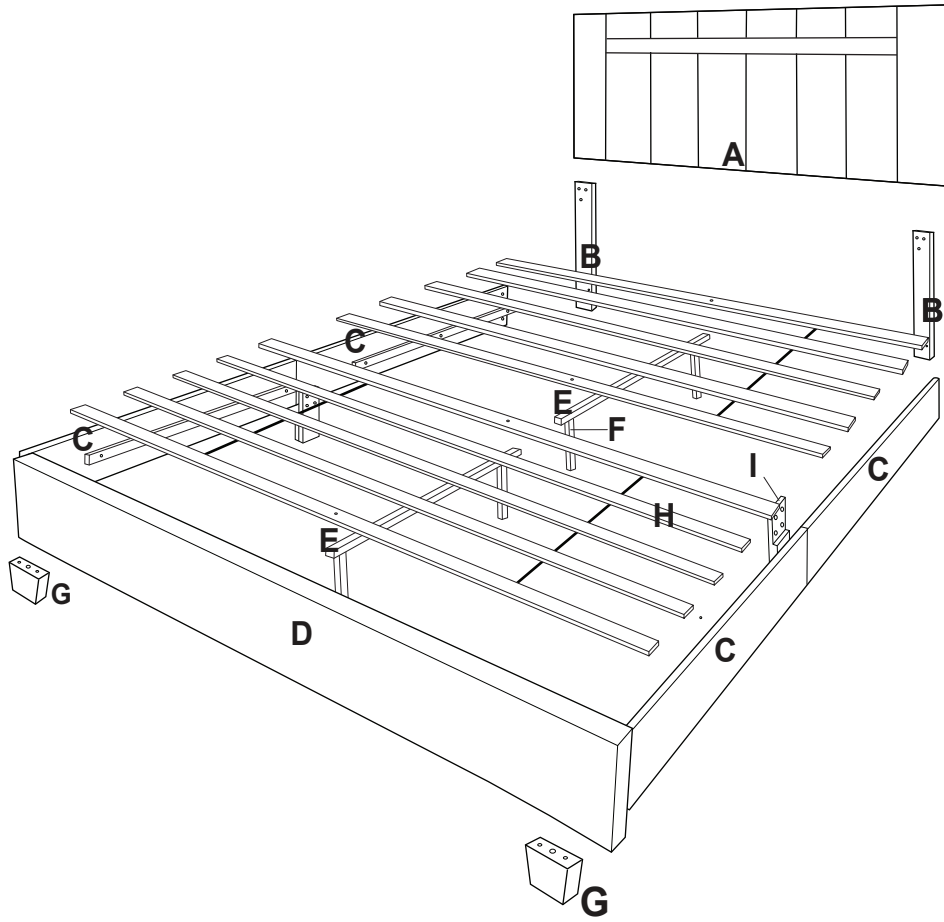





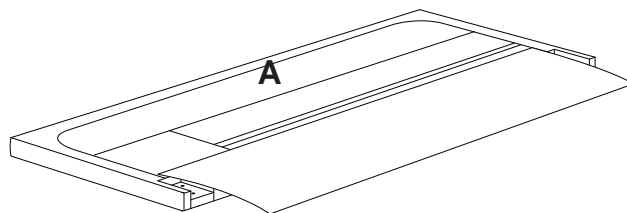

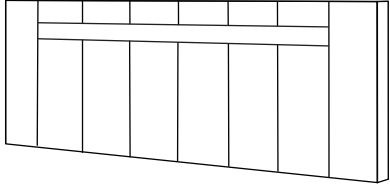

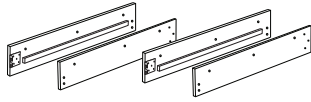
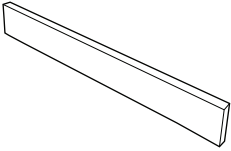
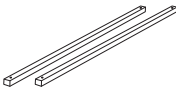
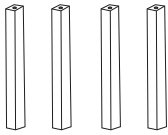
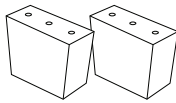
Detail View - SRN 5804

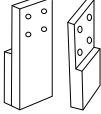

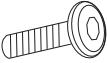
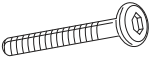
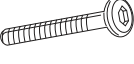
Bed Parts are shipped inside a compartment
in the back of the headboard & footboard.

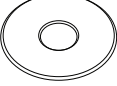

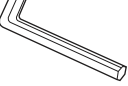
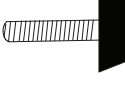
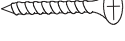
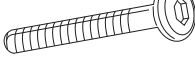
NO	PART LIST	QTY
A	Headboard 	1 pc
B	Headboard Leg 	2 pcs
C	Side Rail 	4 pcs
D	Footboard 	1 pc
E	Center Rail 	2 pcs
F	Center Support Leg 	4 pcs
G	Bed Leg 	2 pcs
H	Bed Slat 	10 pcs
I	Side Rail Support 	2 pcs

NO	HARDWARE LIST	QTY
1	JCBB M8 x 20mm 	8 pcs
2	JCBC M6 x 60mm 	4 pcs
3	JCBC M6 x 40mm 	6 pcs
4	JCBC M6 x 25mm 	8 pcs
5	Spring Washer m6 	6 pcs
6	Flat Washer M6 	14 pcs
7	Allen Key M4 (100mm) 	1 pc
8	Allen Key M5 	1 pc
9	Adjuster M6 	4 pcs
10	CSK M4 x 30mm 	20 pcs
11	JCBC M6 x 70mm 	2 pcs
12	Dowel M8 x 30 mm 	4 pcs



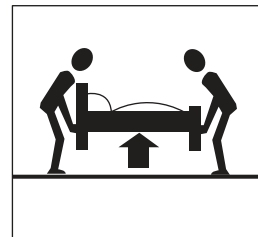
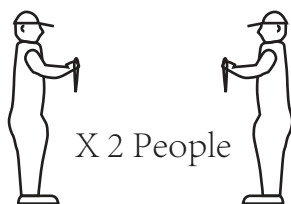

Read this instruction carefully. Remove all wrapping material, staples and straps from the carton. See hardware and furniture part list for guidance. Be sure you have all wooden furniture parts on a clean and flat surface, such as carpet or rug, to prevent from being scratched.

CAUTION :

1. Do not Full Tighten the nut or screw until all ready to assemble.
2. Do not Over Tighten the nut or screw to avoid causing damages to the thread.
3. Keep all hardware part out reach of children.



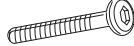

STEP 1

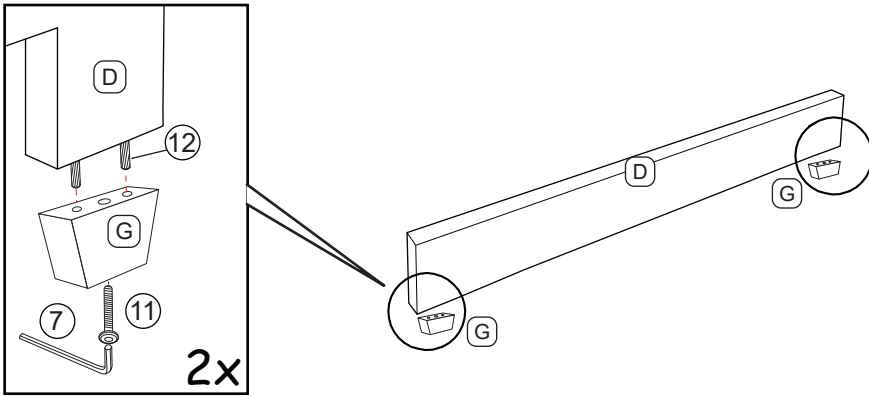
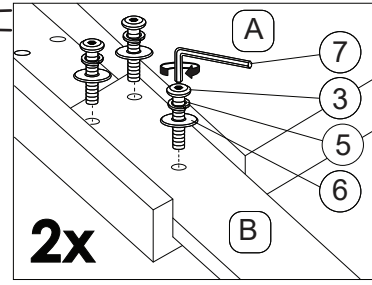
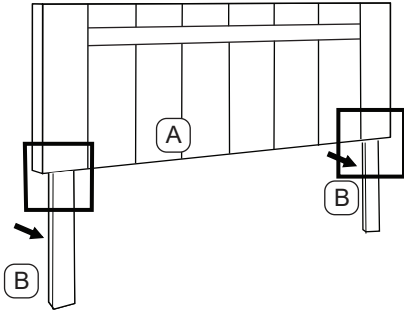
5	3	11	6	12
				
6 pcs	6 pcs	2 pcs	6 pcs	4 pcs



STEP 2

4	6
	
8 pcs	8 pcs

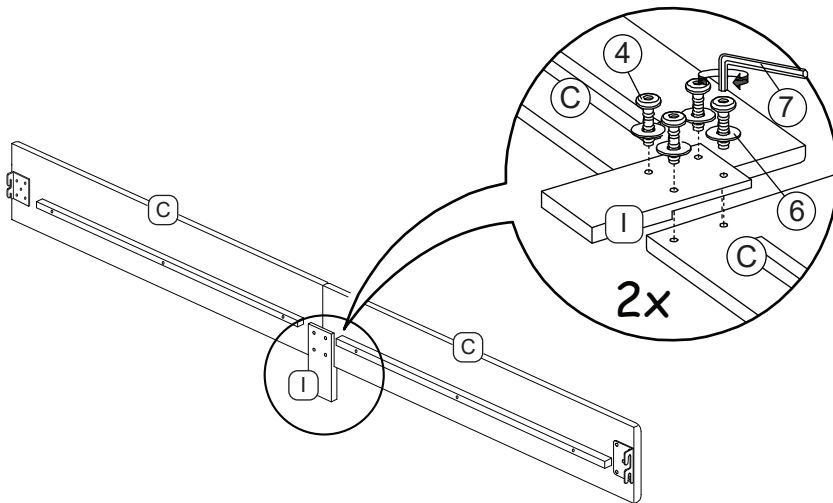

STEP 3

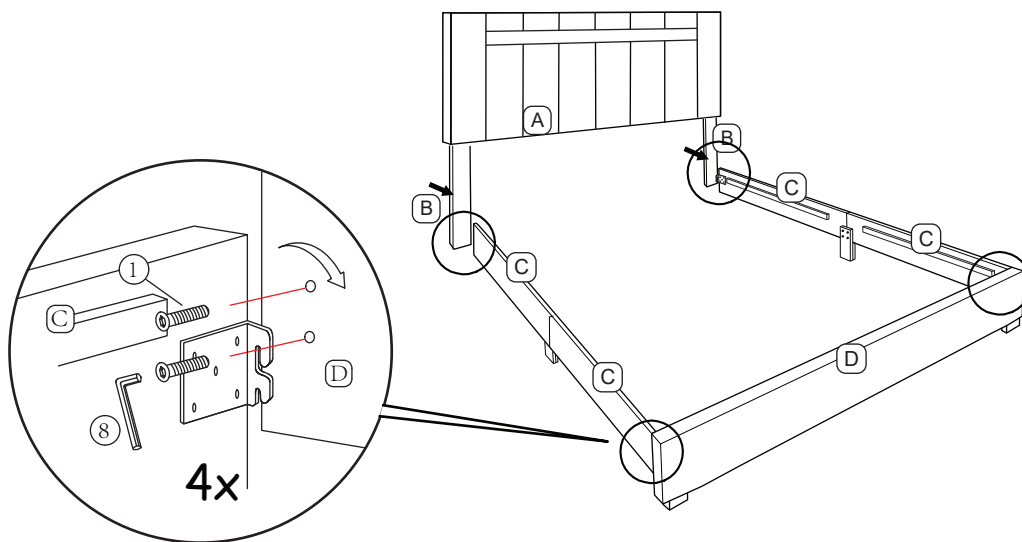
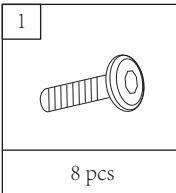

STEP 4

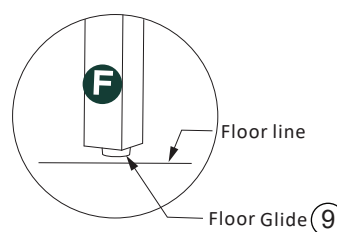
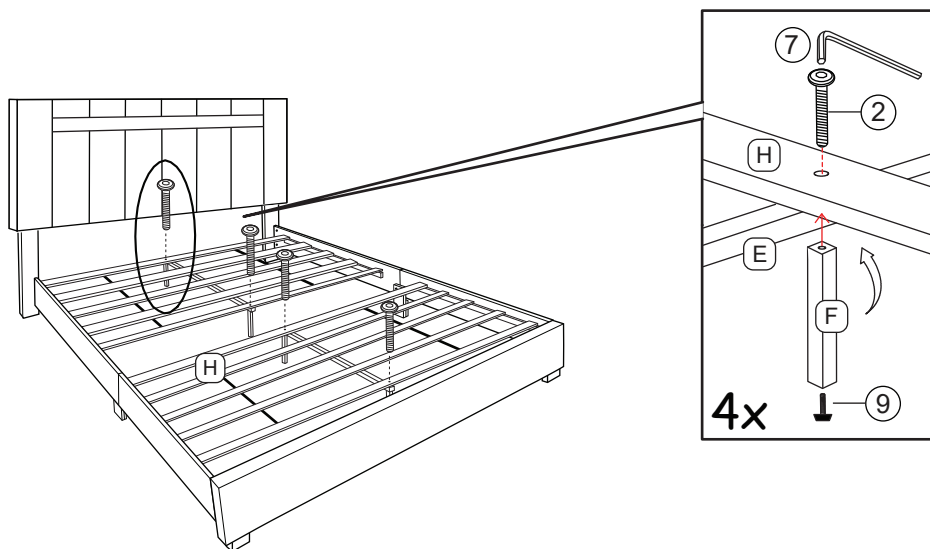
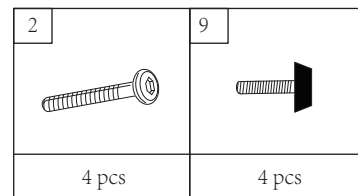

NOTE:

The center support leg glide recommended adjusted approximately 1/4" off of the floor. The glide will touch the floor after a mattress is placed on the bedframe.

Do not place a mattress on bedframe until it is fully assembled and the bedframe located in your desired location. Sliding the bed with weight upon it can compromise the integrity of the center support legs.

STEP 5

10



20 pcs

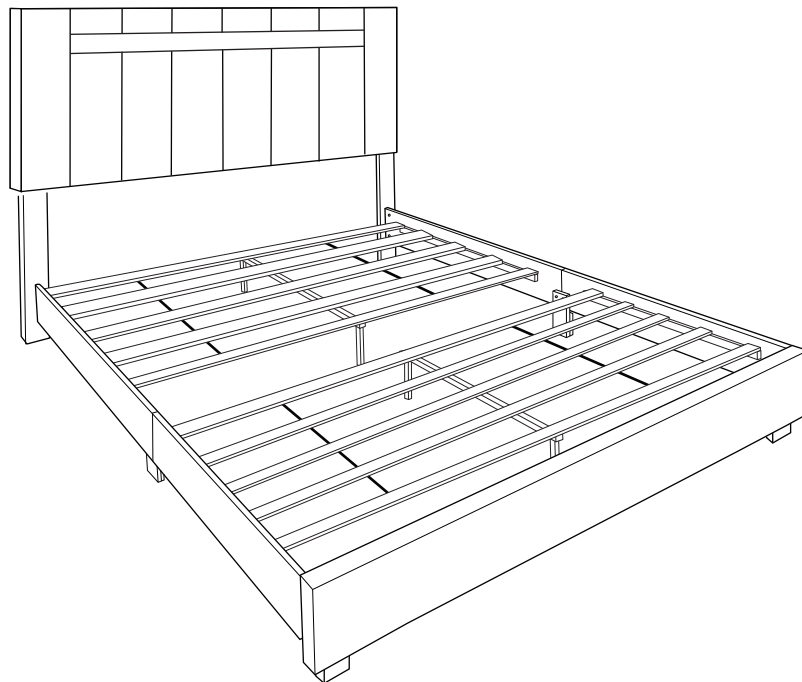
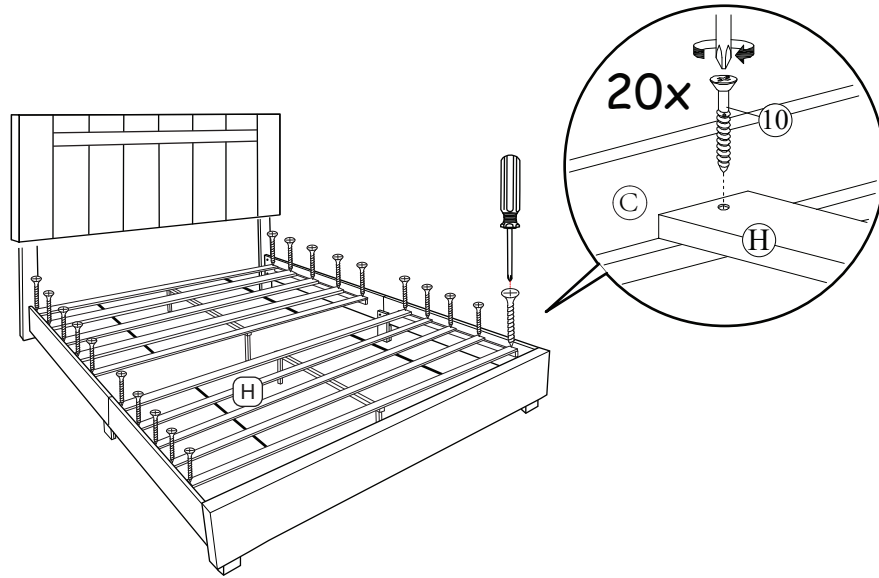

COMPLETED
ASSEMBLY