

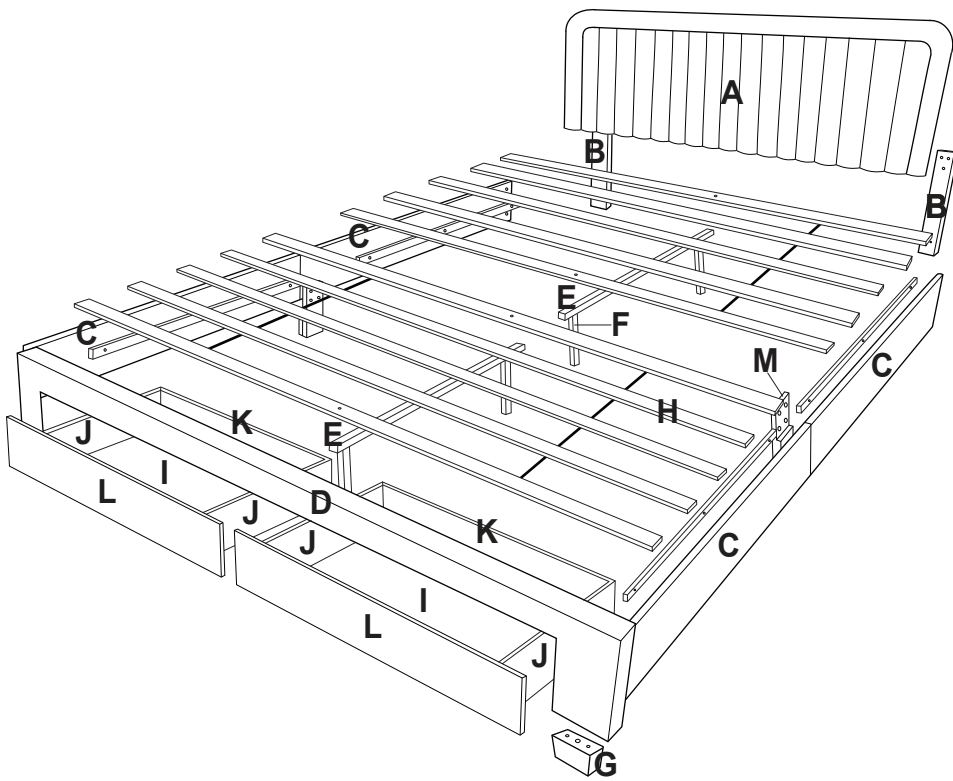

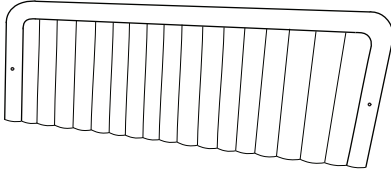



ASSEMBLY INSTRUCTION



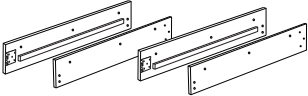
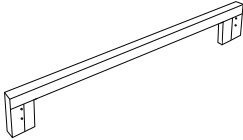

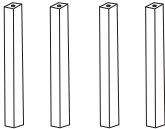
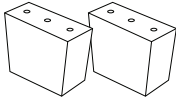

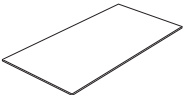
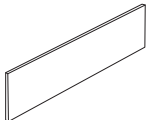

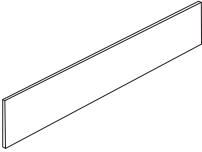
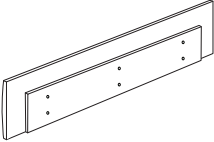
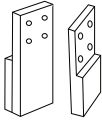
SRN-2011

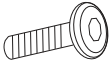

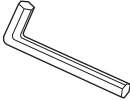
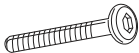
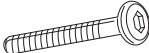
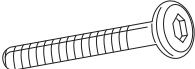
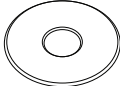

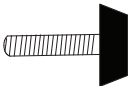
NO	PART LIST	QTY
A	Headboard 	1 pc
B	Headboard Leg 	2 pcs
C	Side Rail 	4 pcs
D	Footboard 	1 pc
E	Center Rail 	2 pcs
F	Center Support Leg 	4 pcs
G	Bed Leg 	2 pcs
H	Bed Slat 	10 pcs
I	Drawer Bottom Panel 	2 pcs
J	Drawer Side Panel 	4 pcs

NO	PART LIST	QTY
K	Drawer Back Panel 	2 pcs
L	Drawer Front Panel 	2 pcs
M	Side Rail Support 	2 pcs

NO	HARDWARE LIST	QTY
1	JCBB M8 x 20mm 	8 pcs
2	Wheel 	8 pcs
3	JCBC M6 x 25mm 	8 pcs
4	Allen Key M5 	1 pc
5	JCBC M6 x 40mm 	6 pcs
6	JCBC M6 x 60mm 	4 pcs
7	JCBC M6 x 70mm 	2 pcs
8	Flat Washer M6 	14 pcs
9	Adapter 	1 pc
10	Adjuster M6 	4 pcs
11	CSK M4 x 30mm 	36 pcs
12	CSK M3.5 x 12mm 	24 pcs
13	Dowel M8 	4 pcs

NO	HARDWARE LIST	QTY
14	Allen Key M4 	1 pc

Read this instruction carefully. Remove all wrapping material, staples and straps from the carton. See hardware and furniture part list for guidance. Be sure you have all wooden furniture parts on a clean and flat surface, such as carpet or rug, to prevent from being scratched.

CAUTION :

1. Do not Full Tighten the nut or screw until all ready to assemble.
2. Do not Over Tighten the nut or screw to avoid causing damages to the thread.
3. Keep all hardware part out reach of children.

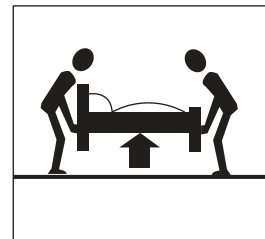
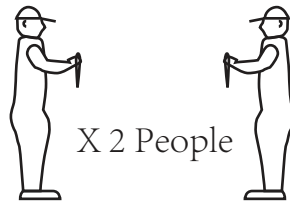

STEP 1 Drawer x 2 pcs



⚠ Use screw driver only

11	12	2
16 pcs	24 pcs	8 pcs

Step 1

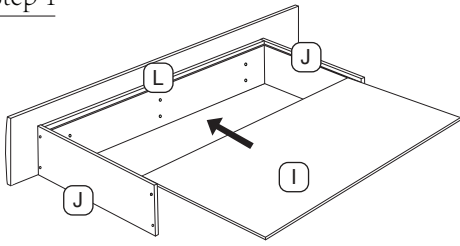

Step 3

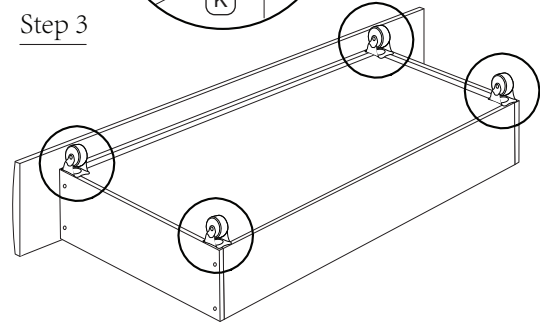
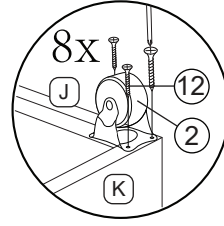

COMPLETED ASSEMBLY

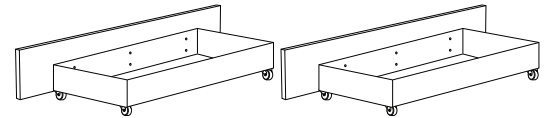

Step 2

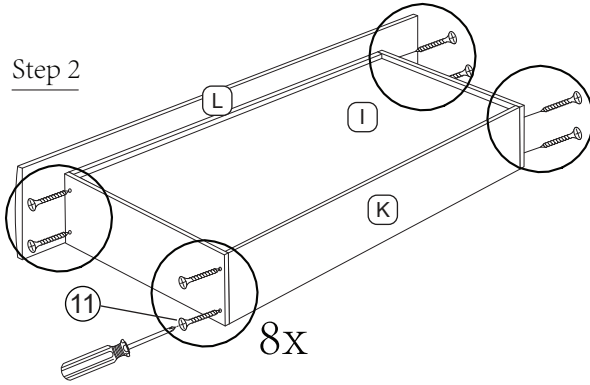

STEP 2

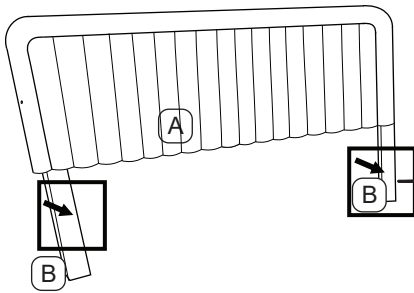

STEP 1

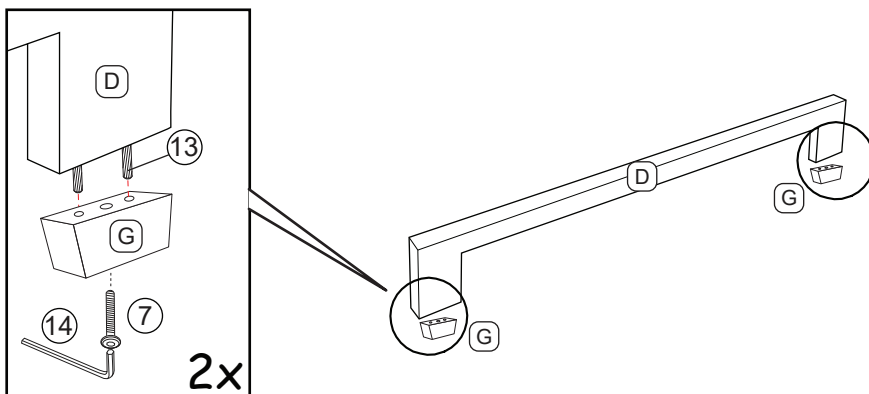
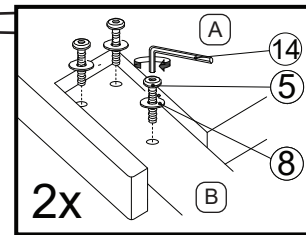

5	7	8	13
6 pcs	2 pcs	6 pcs	4 pcs



STEP 3

3	8
	
8 pcs	8 pcs

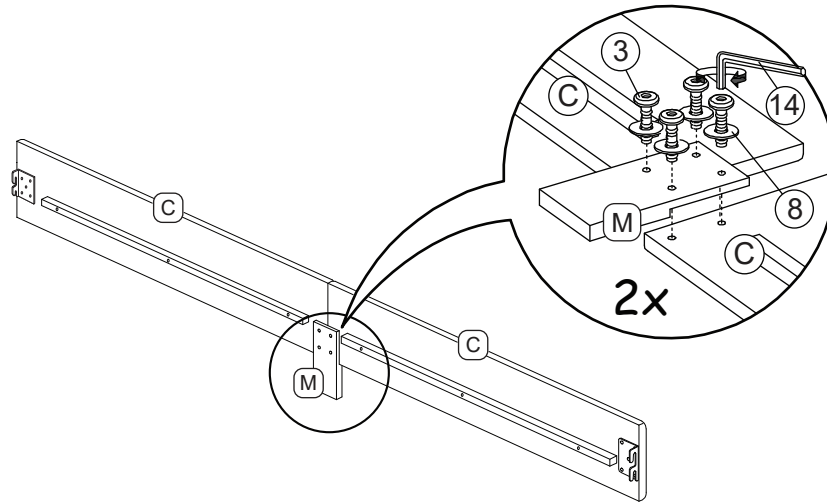

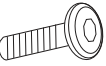

STEP 4

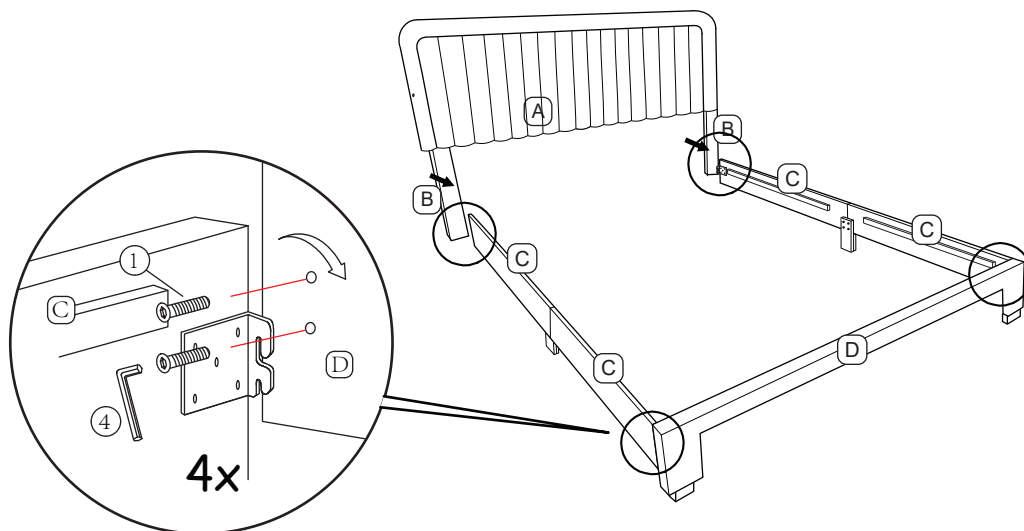
1

8 pcs



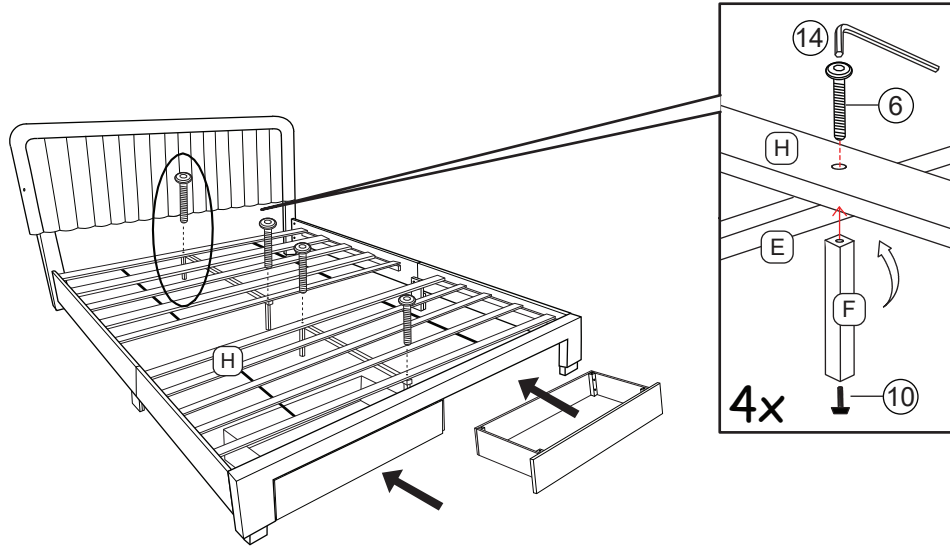

STEP 5

6	10
	
4 pcs	4 pcs



STEP 6

11	9
	
20 pcs	1 pcs

LED LIGHT TOUCH SENSOR SWITCH 

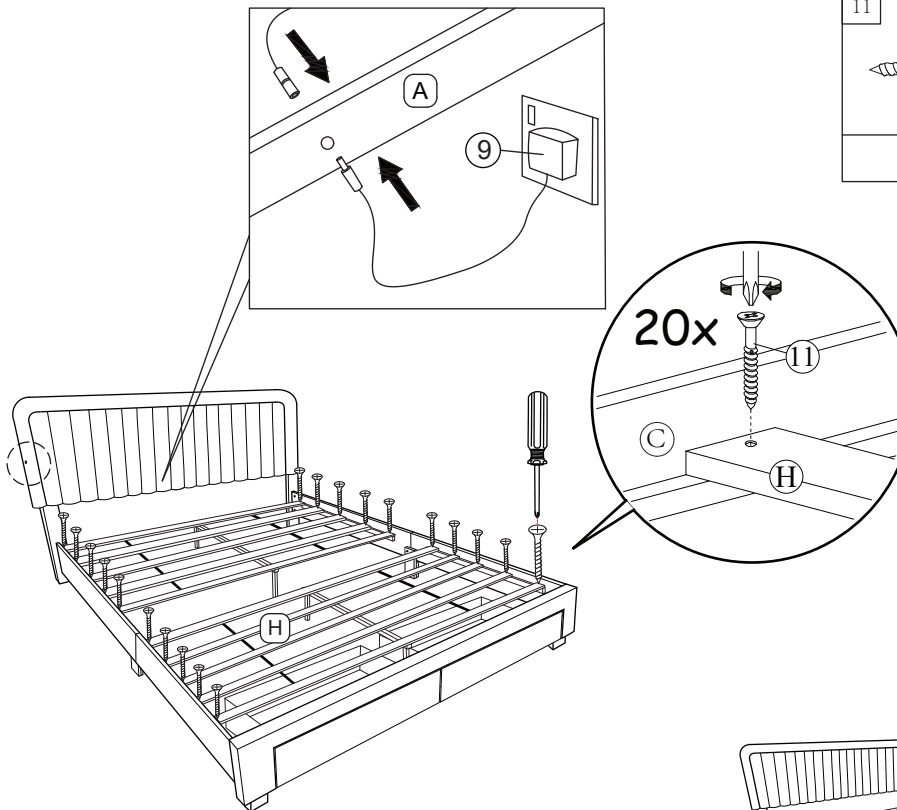

COMPLETED ASSEMBLY