

FAQ

Q1: Missing parts when received.

A: If you find some parts are missing from the box, please kindly send us messages to let us know the name of missing part regarding to the first page of instructions. We will send replacement to you asap.

Q2: Some parts damaged when arrived.

A: Please send clear photos about damaged part to us as attachment, we will check and offer you best solution soon.

Q3: The chair is stuck on lifting or reclining position, and no response when you press the lifting or reclining button.

A: Please kindly check if the power cord (F) are connected well with lift motor. Sometimes the power cord (F) may fall off from the motor.

If the connection is good, then check the lift motor if it has some anomaly, like some noise comes out when you press the lift button. If you can make sure the motor is defective, please contact us for replacement.

How to remove the chair ?

Please note that you need to take apart the backrest before.

1. Force apart the buckles while take the backrest out from the arms.

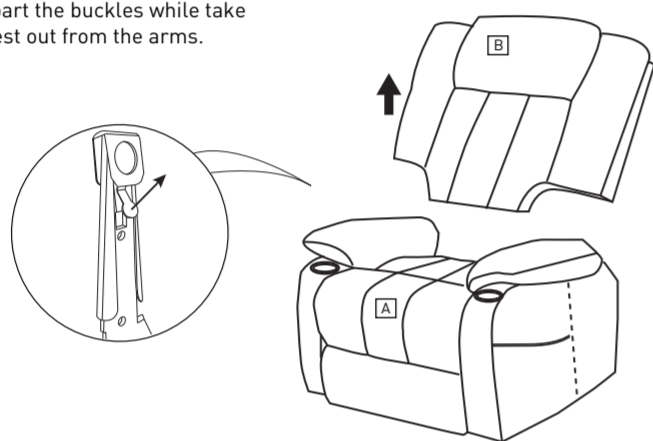

Please make sure you've got everything lists as following before assembly.

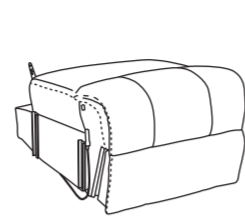

A Chair base

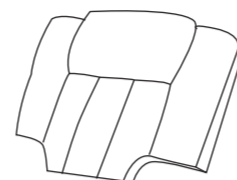

B Backrest

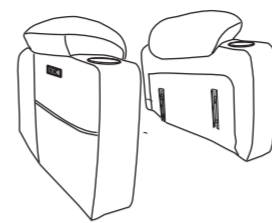

C Left and right armrest

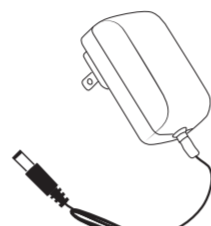

D Power cord



E Remote control

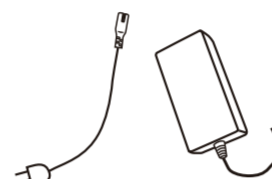

F Power Source

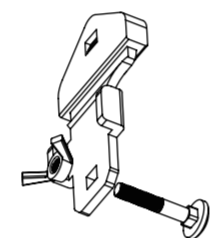

G Anti-fall bracket x2

Power Lift Chair Assembly Instruction

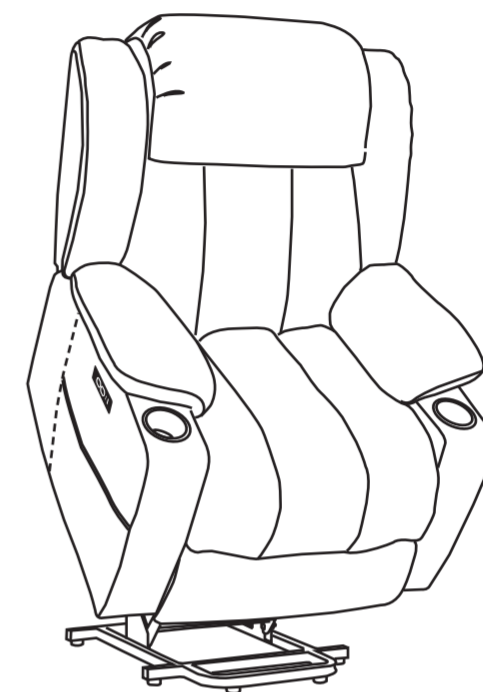

STEP 1

Insert two armrests(C) to the chair base(A), make sure the slots on the armrests fully assembled to the bottom part.

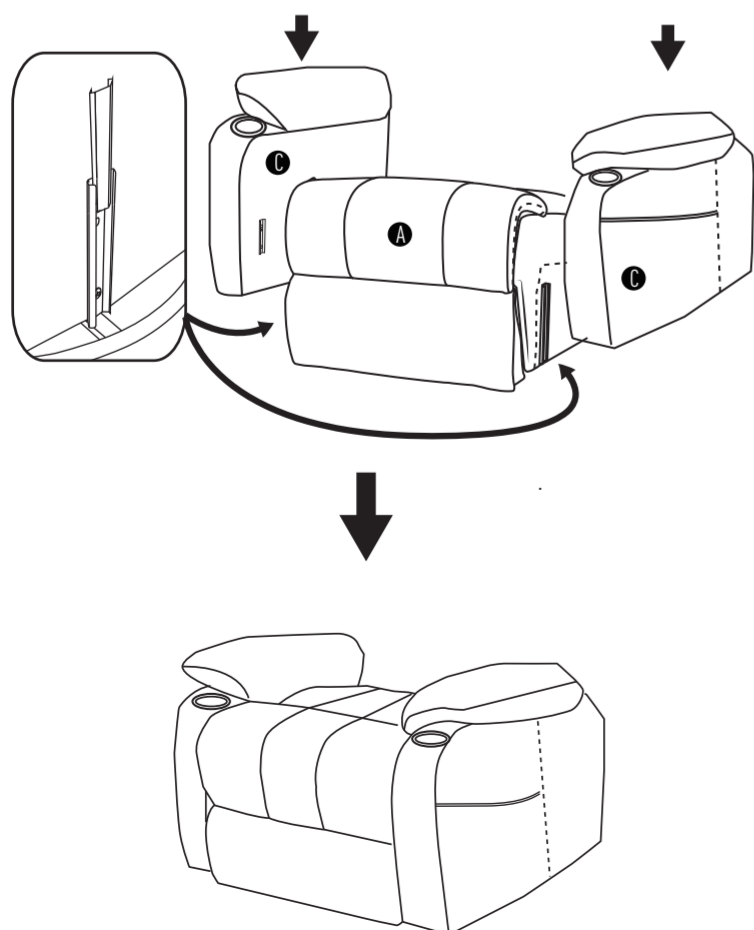

STEP 2

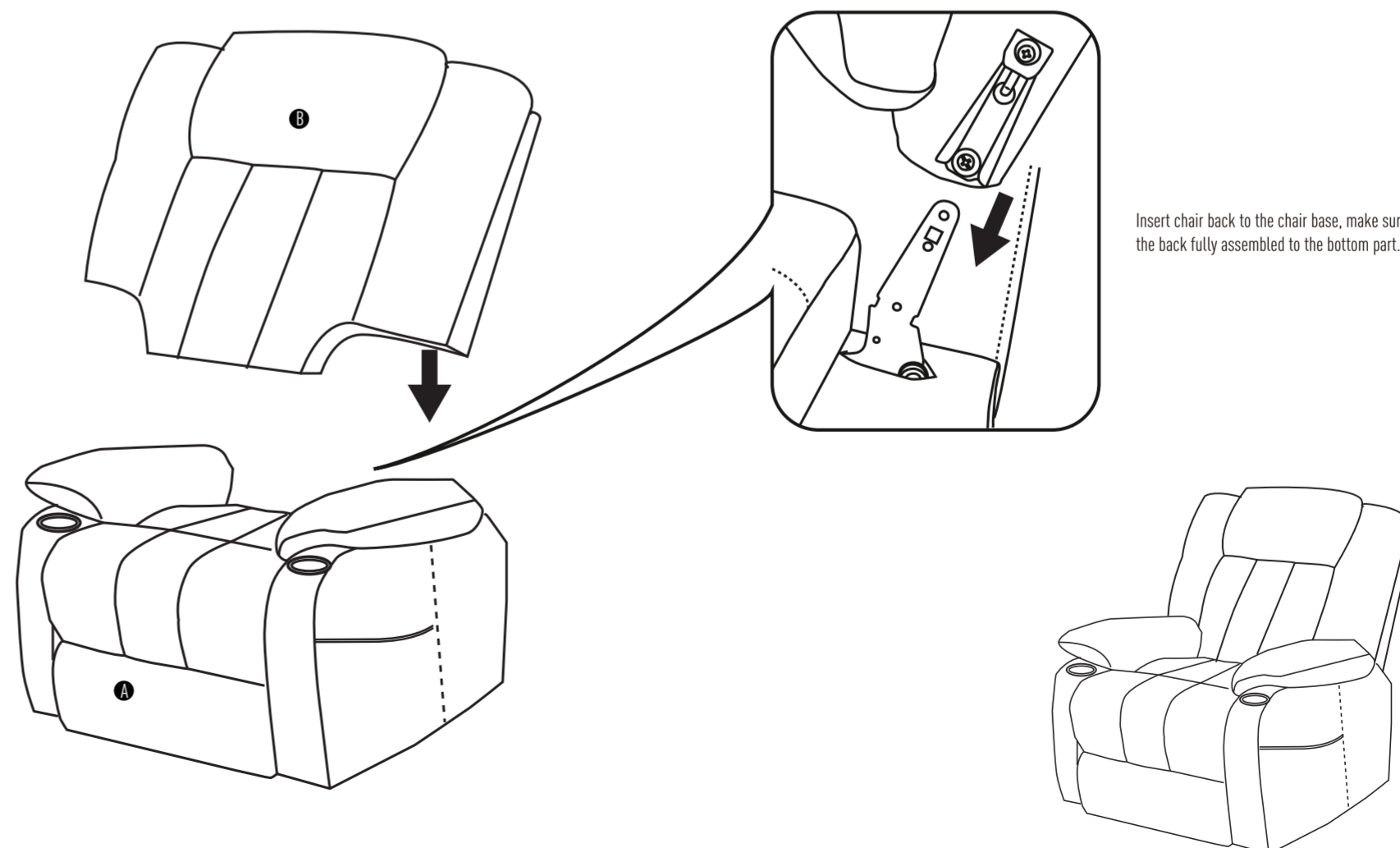

Insert chair back to the chair base, make sure the on the back fully assembled to the bottom part.

STEP 3

- No.1 and No.2 wire connect with the backrest and chair base.
- No.3 wire connects with backrest and power cord(D).
- No.4 wire connects with backrest and remote control(E).
- No.5 wire connect the motor and the wire from rightside armrest, which use to connect the control panel.
- No.6 wire connect the motor and power source (F).

NOTE

- 1: Two same color wires connect.
- 2: Plug power cord and power source into outlet, then you can use all function.

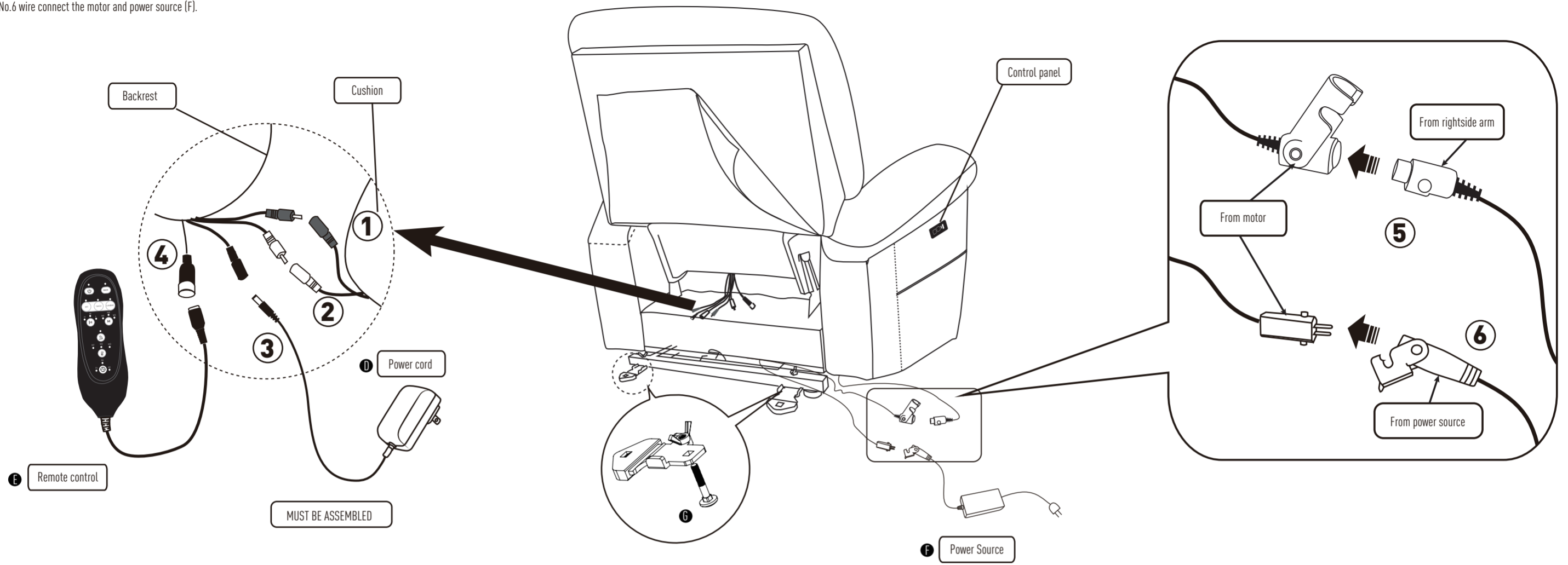

How to recline?

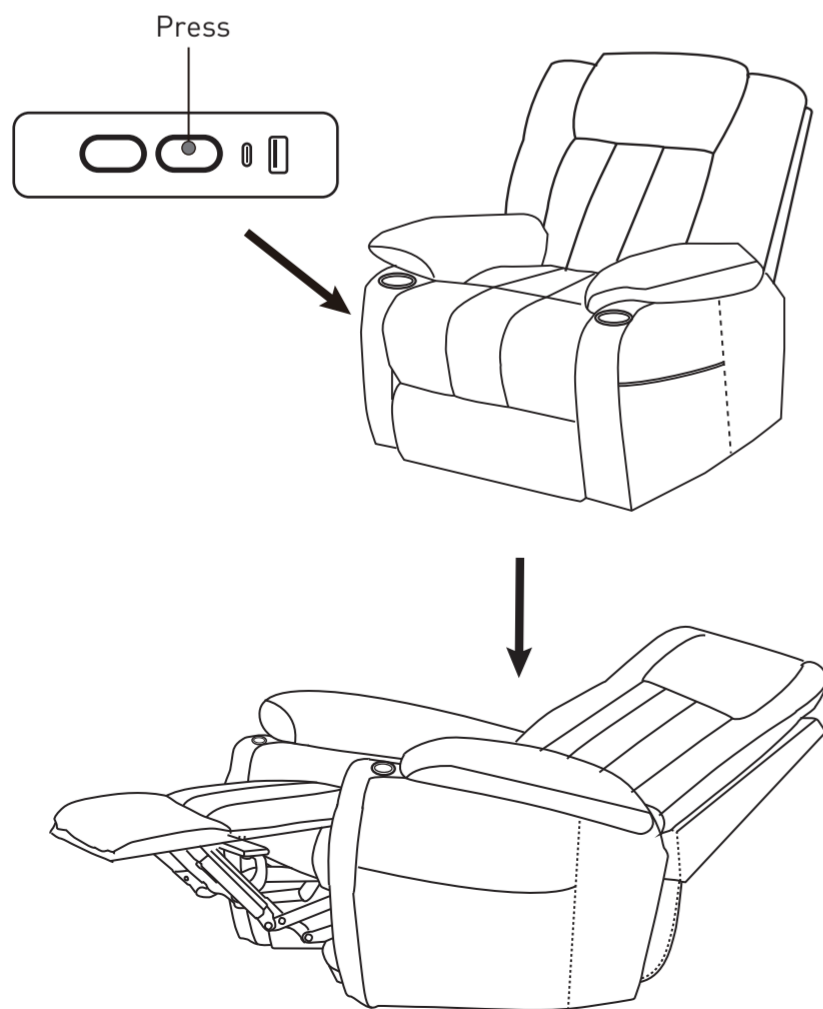

How to get footrest latch down and stand?

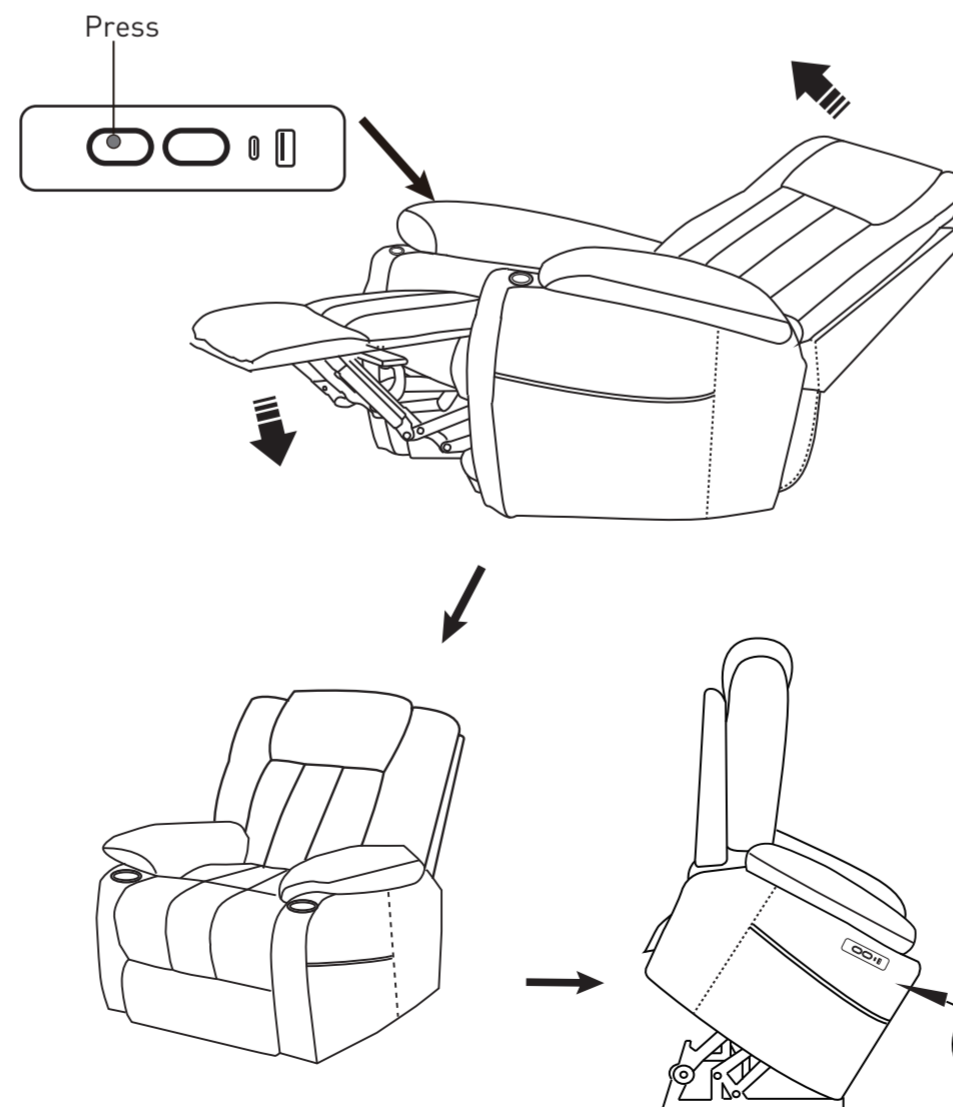

How to use remote control?

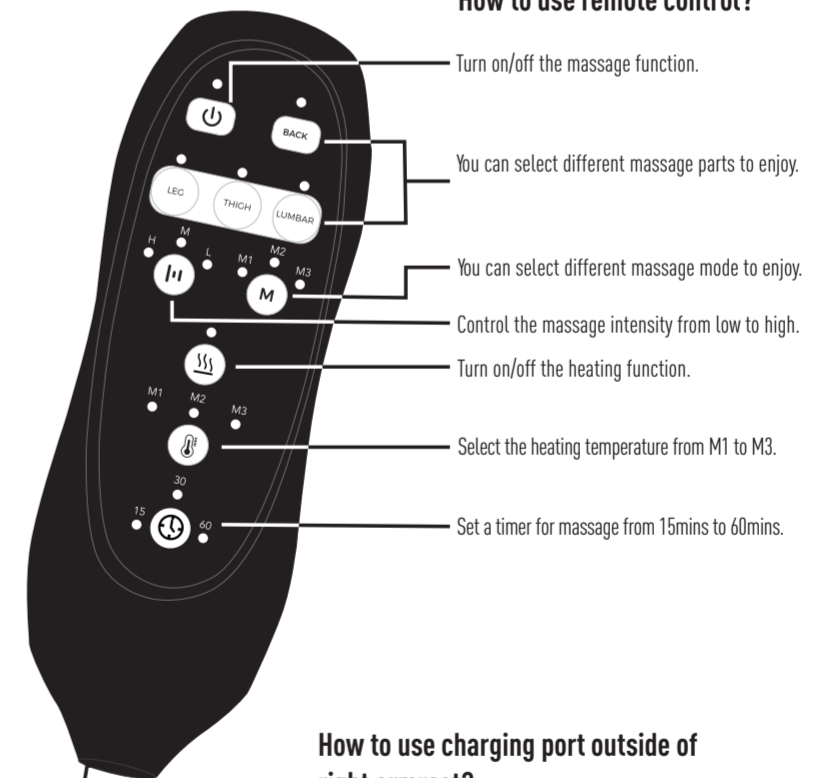

How to use charging port outside of right armrest?

Control Panel is for chair lift and reclining function,also has 1 USB-A outlets and 1 USB-C outlet,which can keep your devices charging,such as nearly all smartphone(like iPhone,Samsung...),iPad,headphones,Kindle etc.

