

## FAQ

### Q1: Missing parts when received.

A: If you find some parts are missing from the box, please kindly send us messages to let us know the name of missing part regarding to the first page of instructions. We will send replacement to you asap.

### Q2: Some parts damaged when arrived.

A: Please send clear photos about damaged part to us as attachment, we will check and offer you best solution soon.

### Q3: The chair is stuck on lifting or reclining position, and no response when you press the lifting or reclining button.

A: Please kindly check if the power cord (F) are connected well with lift motor. Sometimes the power cord (F) may fall off from the motor.

If the connection is good, then check the lift motor if it has some anomaly, like some noise comes out when you press the lift button. If you can make sure the motor is defective, please contact us for replacement.

### How to remove the chair ?

Please note that you need to take apart the backrest before.

1. Force apart the buckles while take the backrest out from the arms.

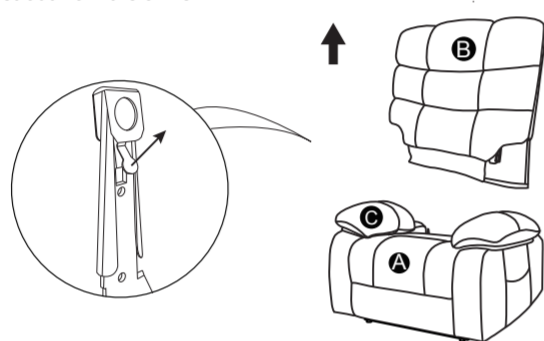

Please make sure you've got everyting lists as following before assembly.

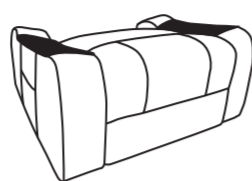

**A** Chair base



**B** Backrest

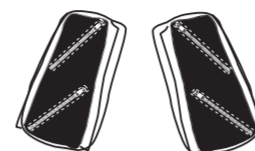

**C** Armrest Cushion x2

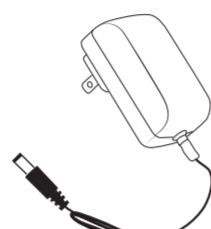

**D** Power cord



**E** Remote control

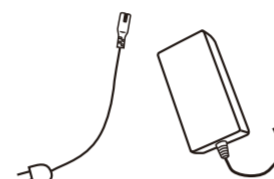

**F** Power Source



**G** Lift control

## Power Lift Chair Assembly Instruction

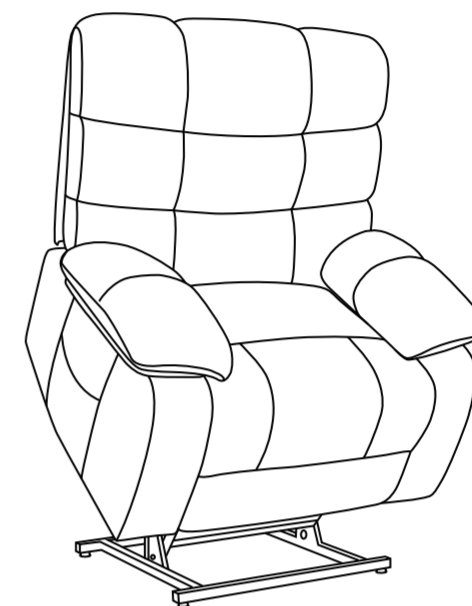

### STEP 1

Zip the zipper to make sure both armrest cushions(C) are well attached to the right direct of arm.

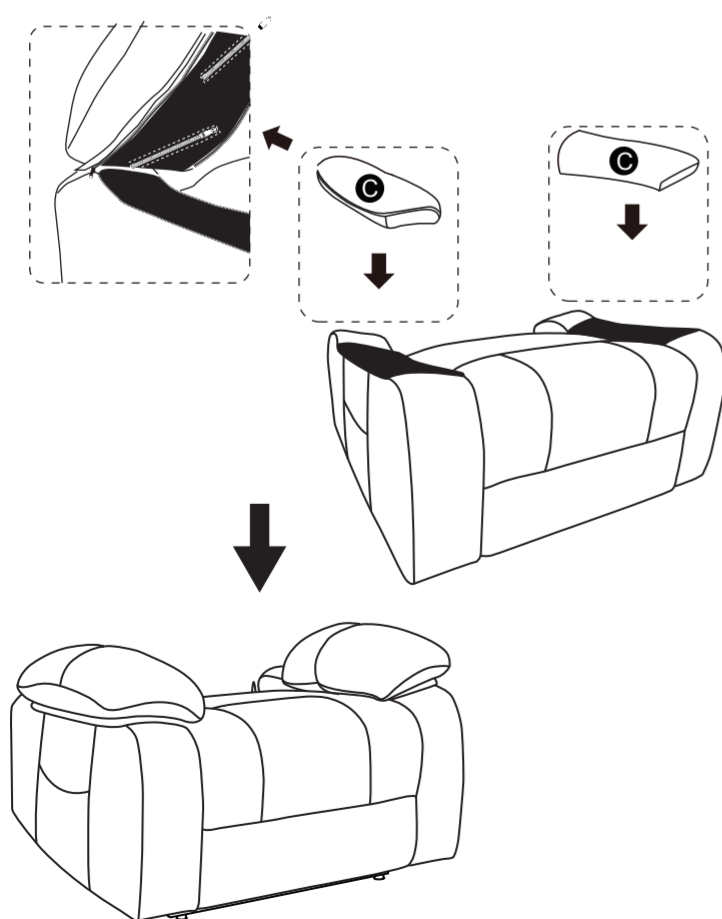

### STEP 2

