

ASSEMBLY INSTRUCTIONS

HYDC-003

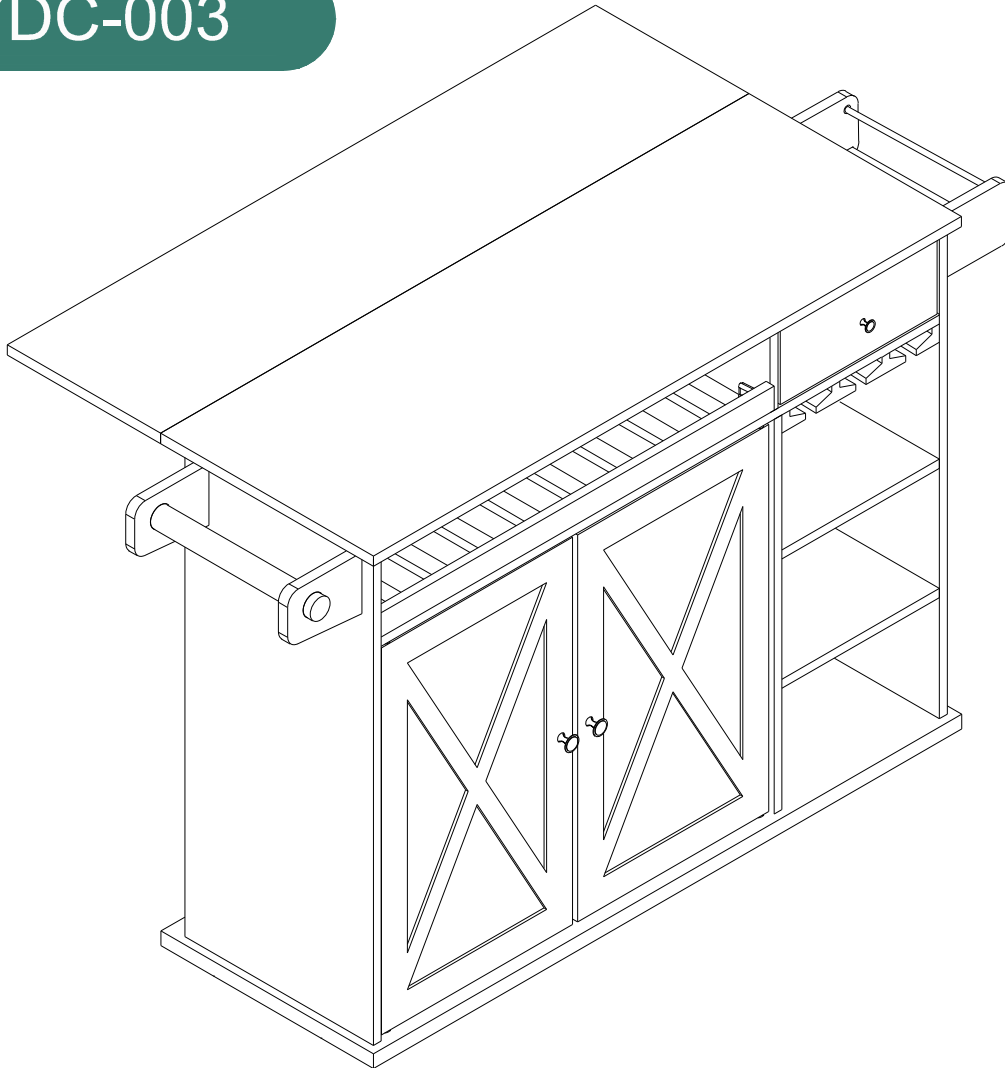

Notice:

1. Follow the installation instructions. Please confirm all accessories are preset before installation.
2. Do not fully tighten the screws during initial assembly. Fully tighten screws only once all pieces which are correctly assembled.
3. If you encounter any problems during installation, please contact our customer service.
4. Please unbox the item from the side with an open-label and put a carpet on the floor to avoid scratching it.

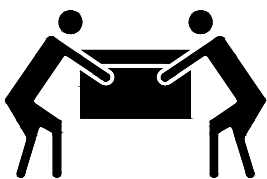

Recommended installers:2

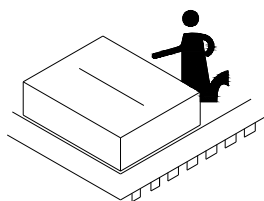



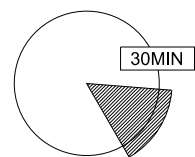



Put a carpet on the floor
before unpacking

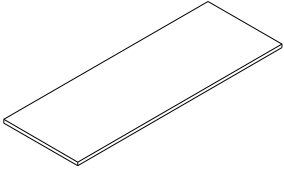

Estimate installation time:
30minutes

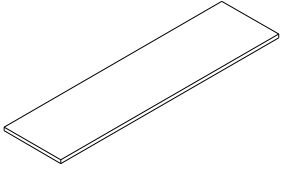
ASSEMBLY INSTRUCTIONS

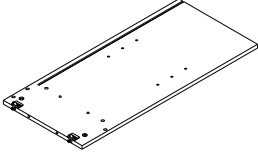
PART LIST

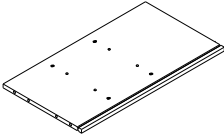
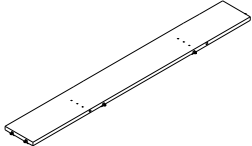
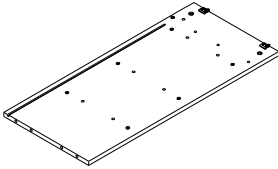
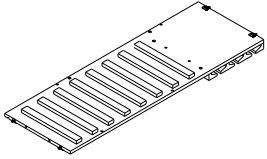
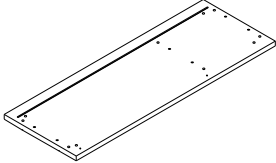
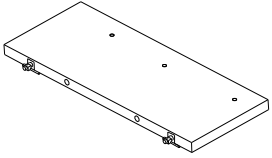
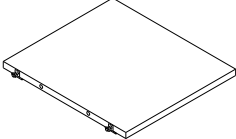
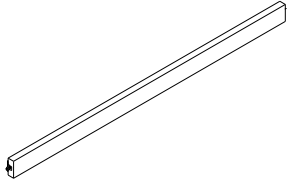
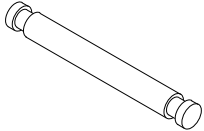
Item no.	Reference Image	Qty	Item no.	Reference Image	Qty
(A)		X1	(I)		X1
(B)		X1	(J)		X1
(C)		X1	(K)		X1
(D)		X1	(L)		X1
(E)		X1	(M)		X1
(F)		X1	(N)		X1
(G)		X1	(O)		X2
(H)		X1	(P)		X1





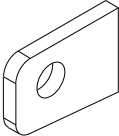
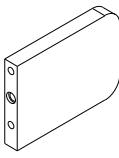
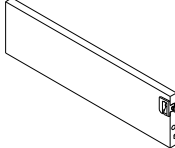
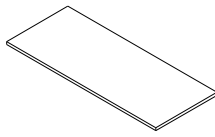
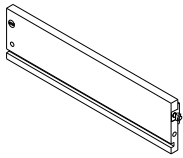
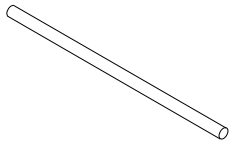
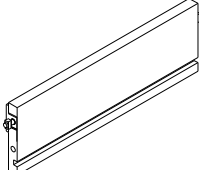
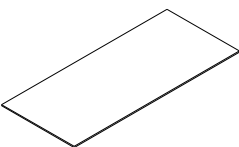
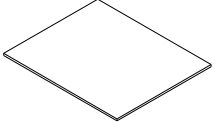
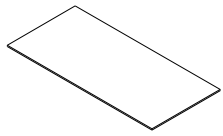
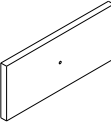
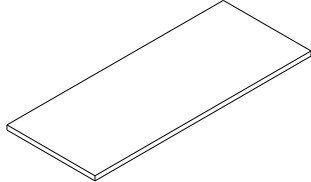
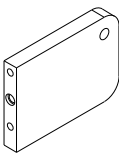





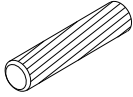

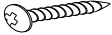

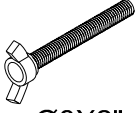
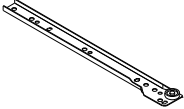
ASSEMBLY INSTRUCTIONS

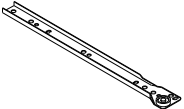
PART LIST

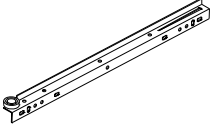
Item no.	Reference Image	Qty	Item no.	Reference Image	Qty
Q		X2	X		X1
R		X1	Y		X1
S		X1	Z		X1
T		X1	AA		X1
U		X1	BB		X1
V		X1	CC		X1
W		X1			

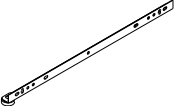
ASSEMBLY INSTRUCTIONS

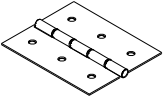
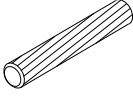
HARDWARE LIST

Item no.	Reference Image	Qty	Item no.	Reference Image	Qty
1	 Ø8X30mm	X42+4	10		X2
2		X1	11	 Ø7XØ3.5X19mm	X16+1
3	 Ø6XØ3X12mm	X42+3	12	 Ø8X2"	X10
4		X1	13		X4
5		X1	14		X3
6		X1	15		X3
7		X1	16	 Ø3X15mm	X2
8		X5	17	 Ø6X30mm	X4
9		X2			

ASSEMBLY INSTRUCTIONS

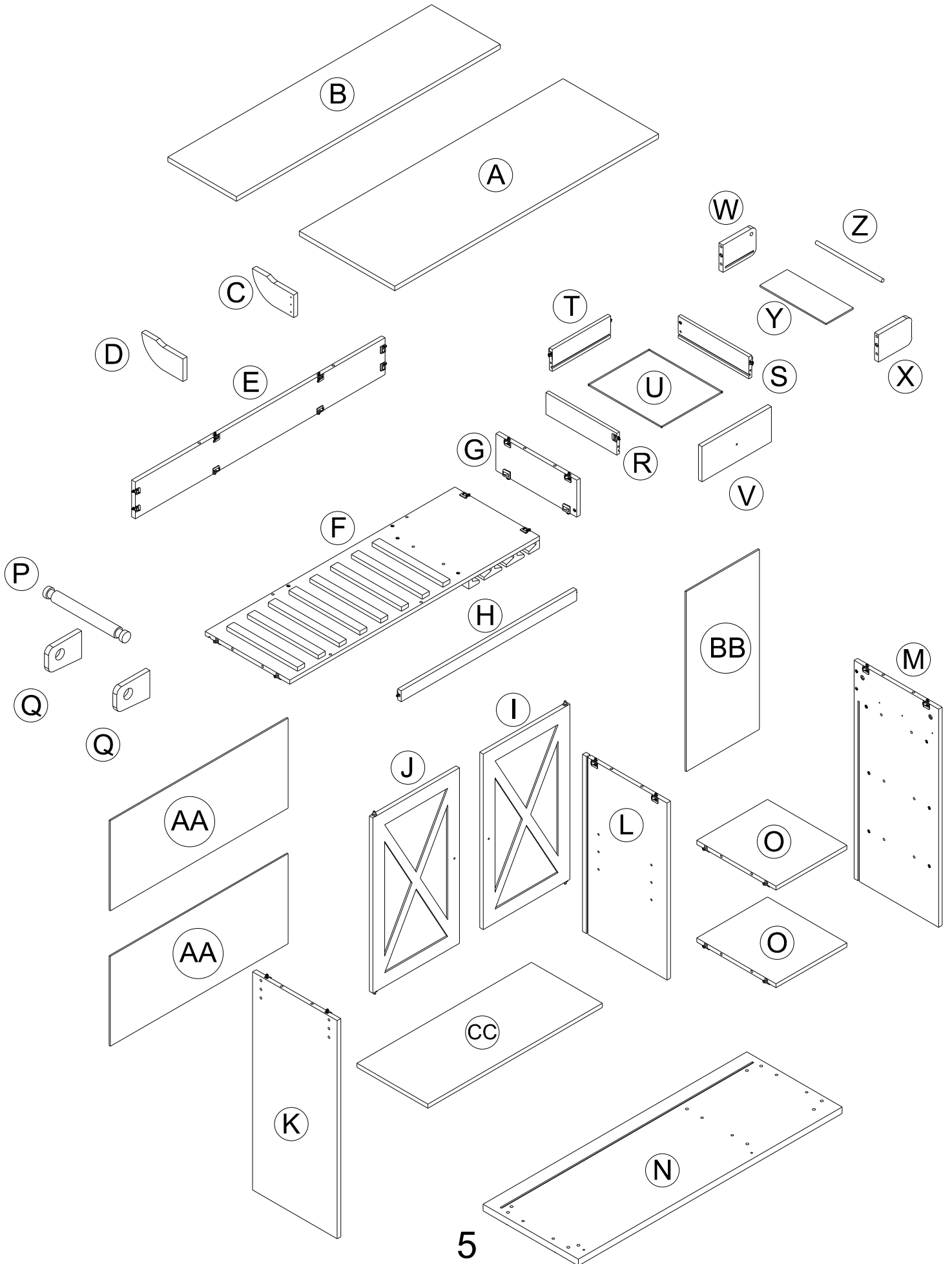

ASSEMBLY INSTRUCTIONS

1

- (M) 1pc (G) 1pc (R) 1pc (S) 1pc (4) 1pcs (5) 1pcs (6) 1pcs (7) 1pcs (3) 12pcs

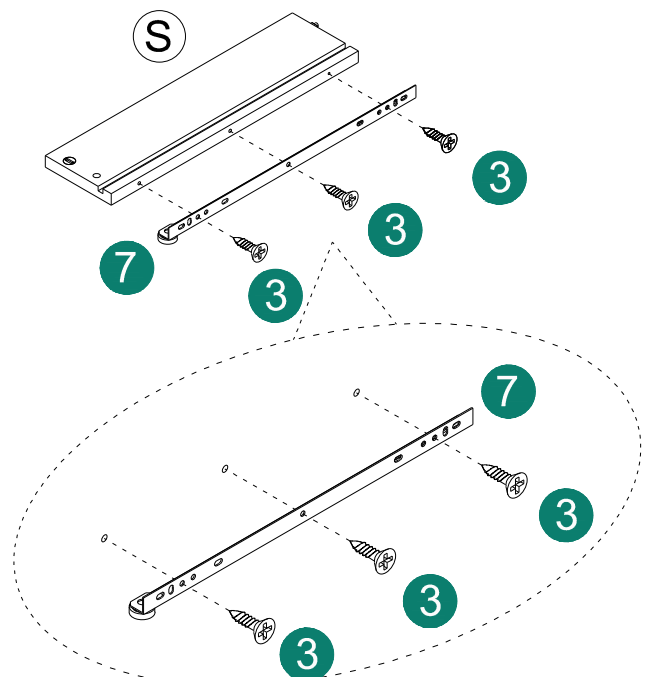
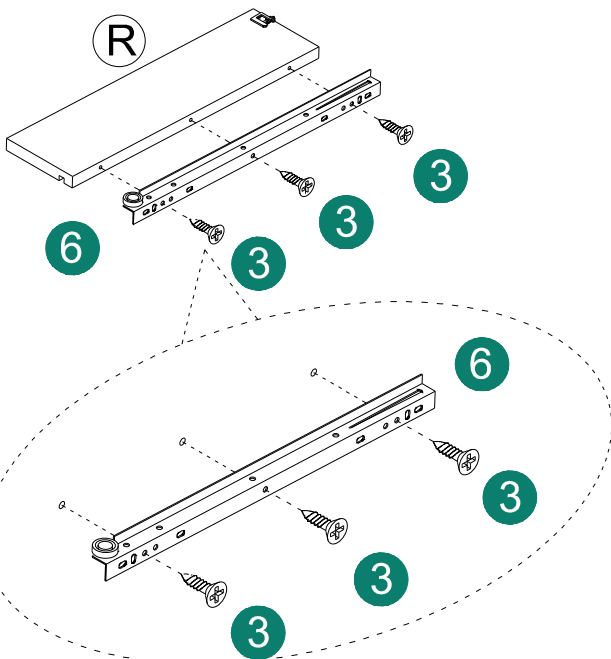
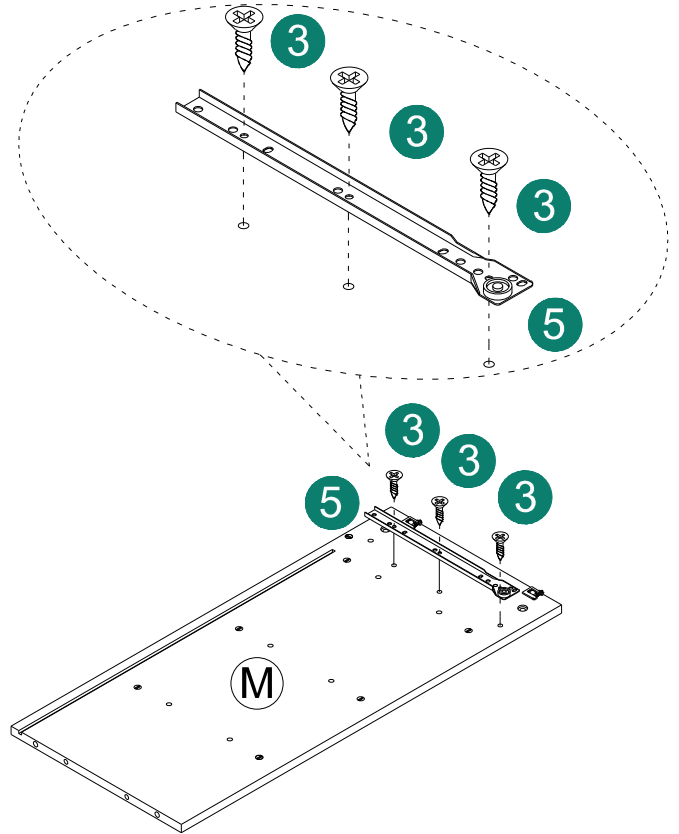
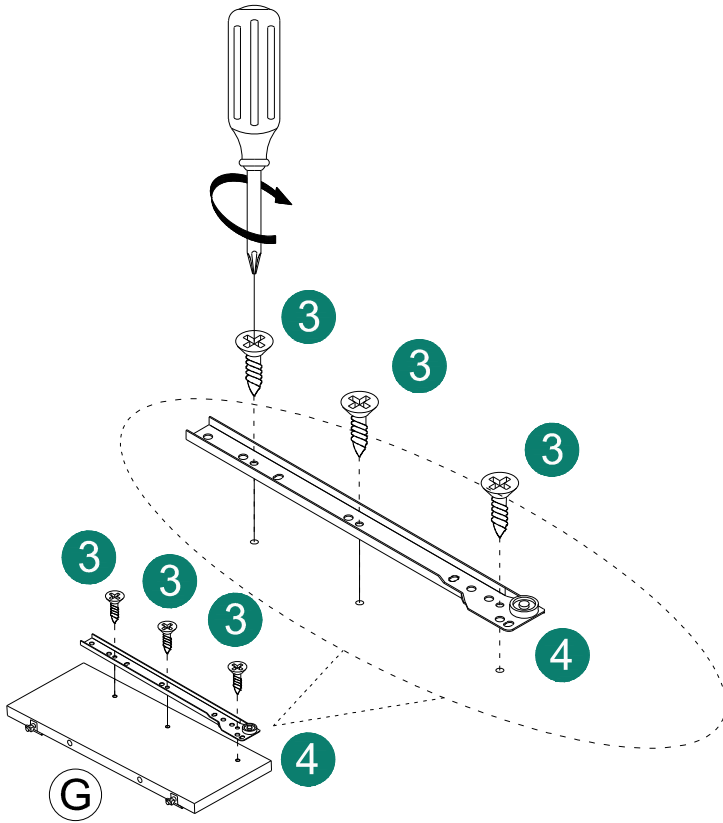

ASSEMBLY INSTRUCTIONS

2

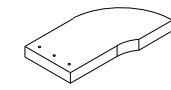

(C) 1pc

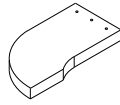

(D) 1pc

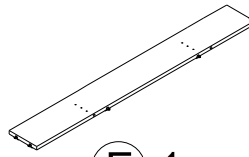

(E) 1pc

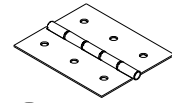

(8) 2pcs



(3) 12pcs

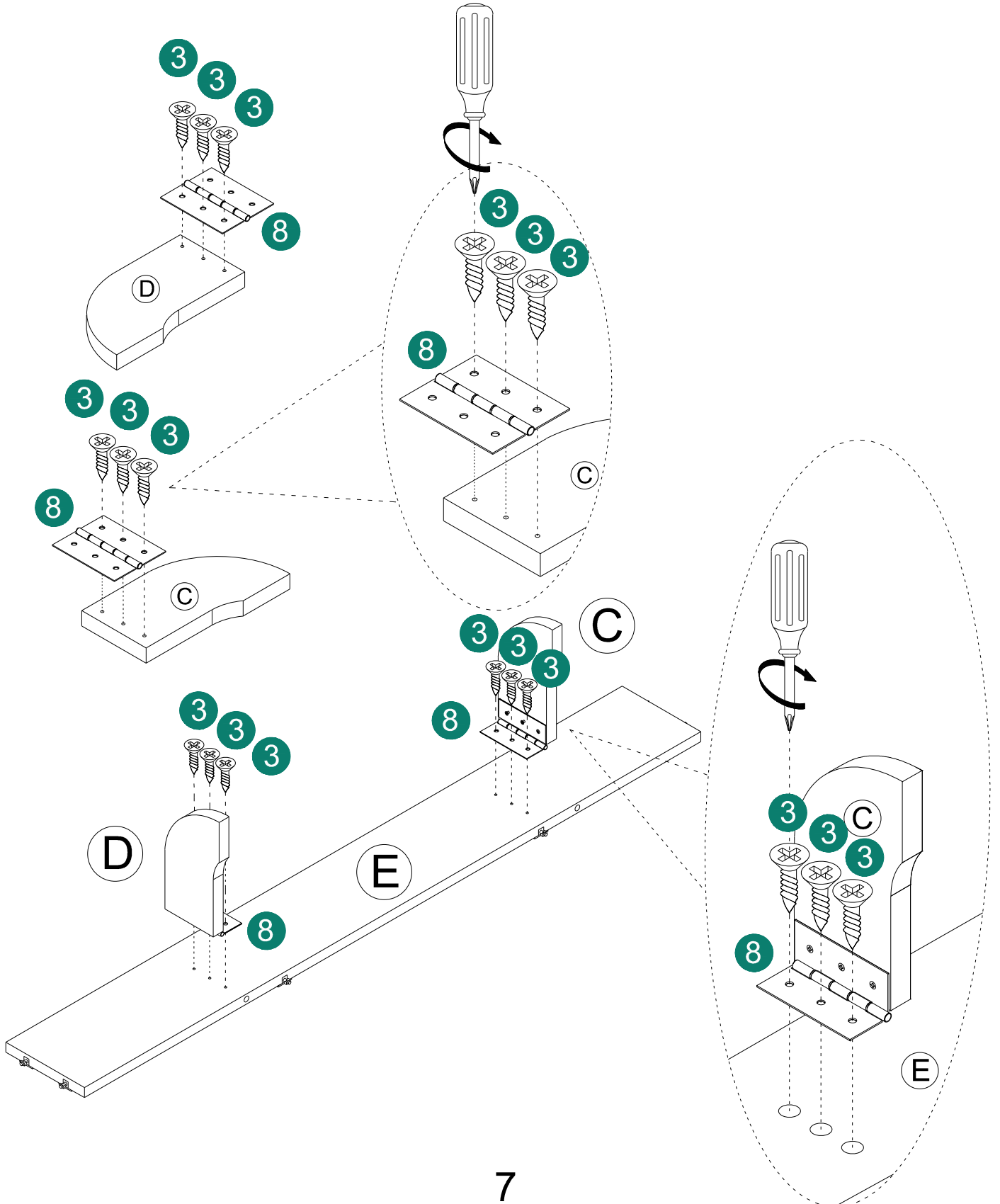

ASSEMBLY INSTRUCTIONS

3

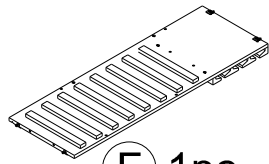

F 1pc

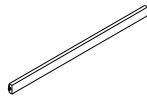

H 1pc

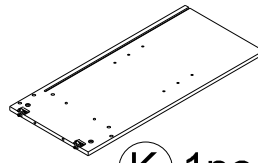

K 1pc

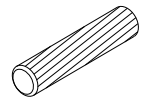

1 2pcs

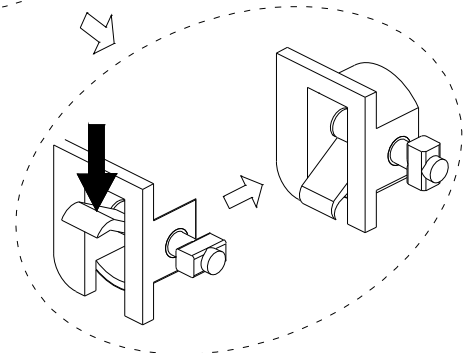
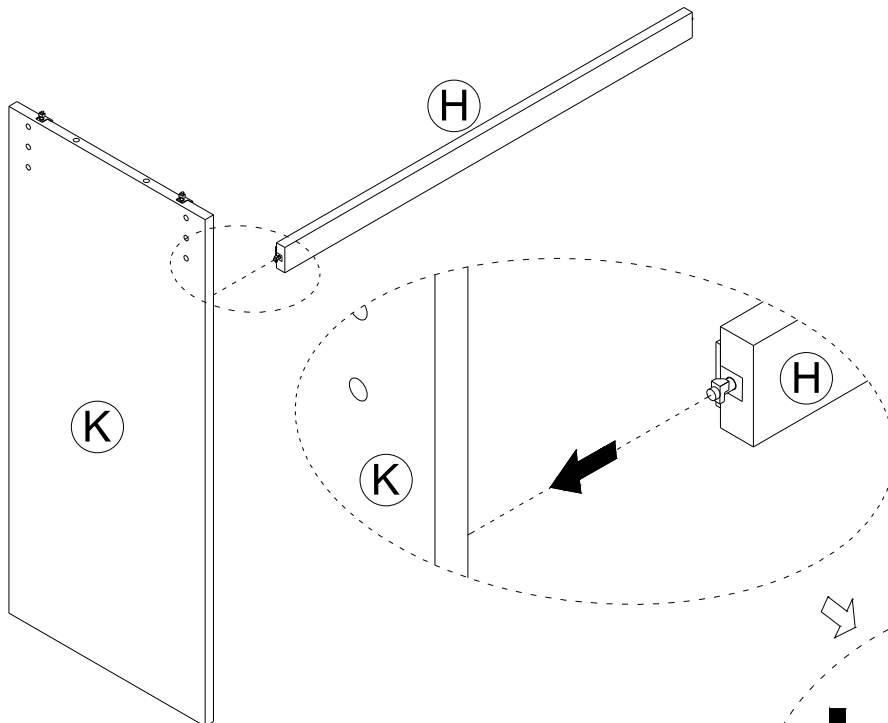
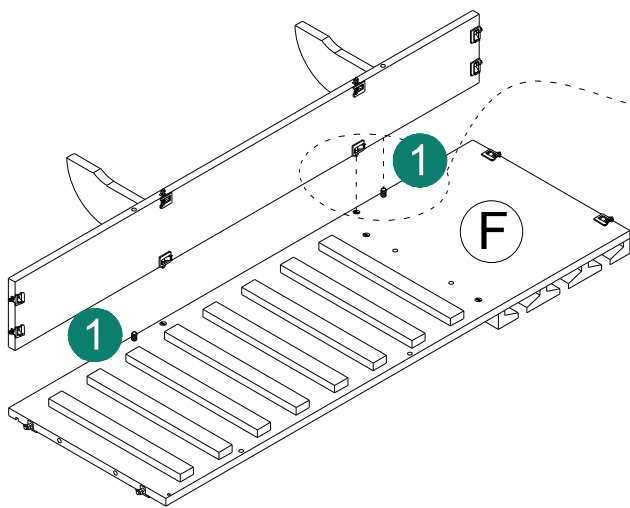

ASSEMBLY INSTRUCTIONS

4

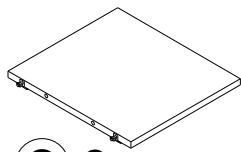

○ 2pc

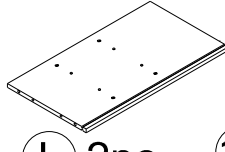

Ⓛ 2pc



⑩ 2pcs

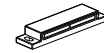

② 1pcs

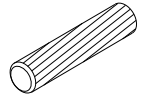

① 4pcs

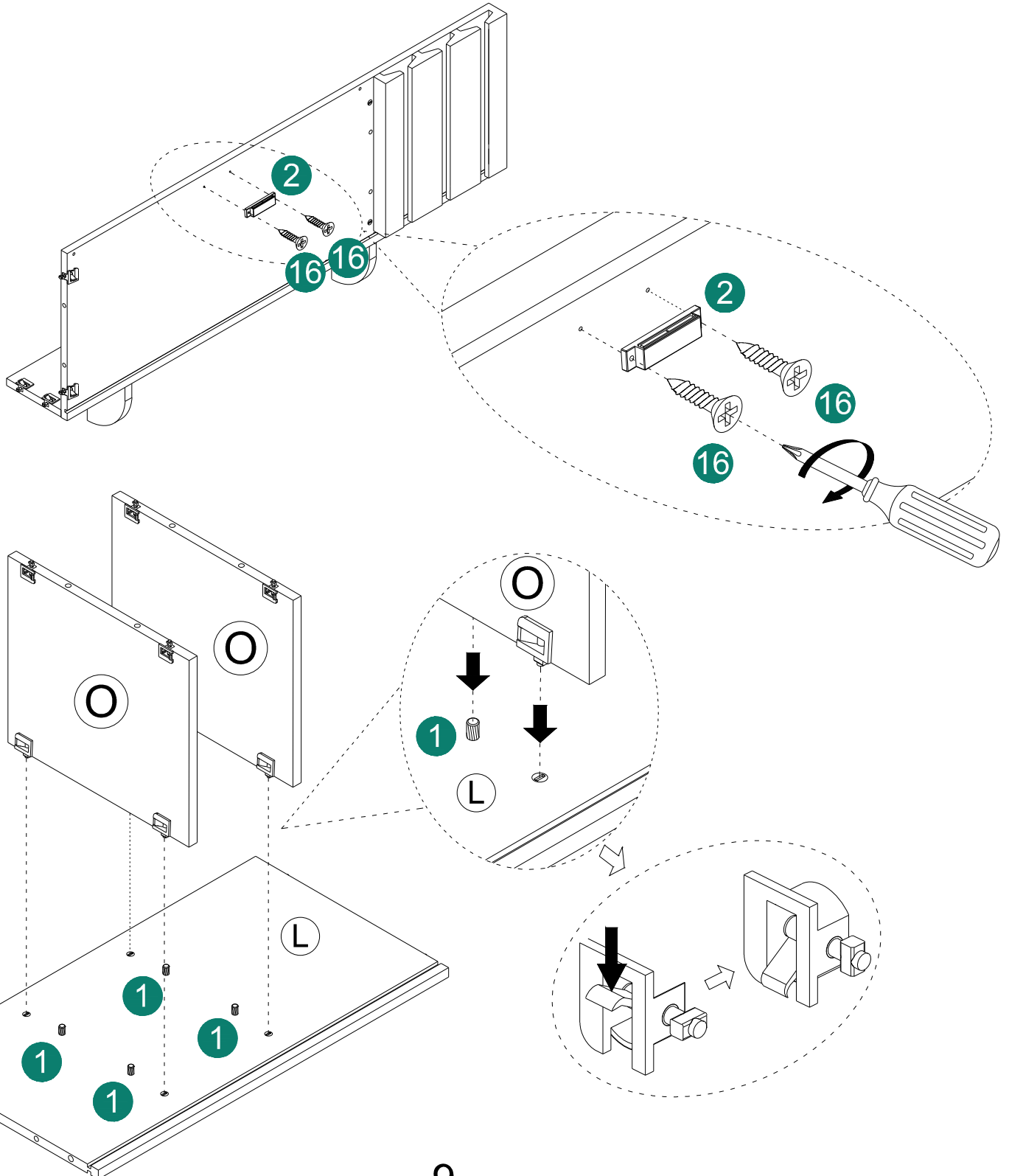

ASSEMBLY INSTRUCTIONS

6

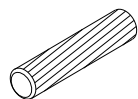

1 4pcs

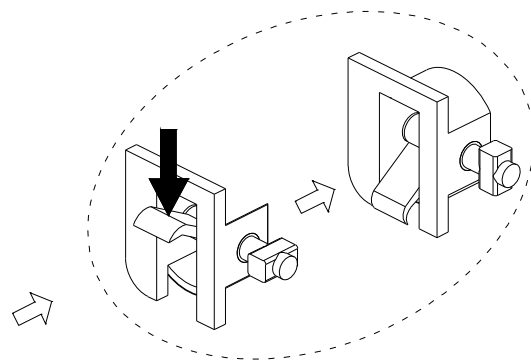
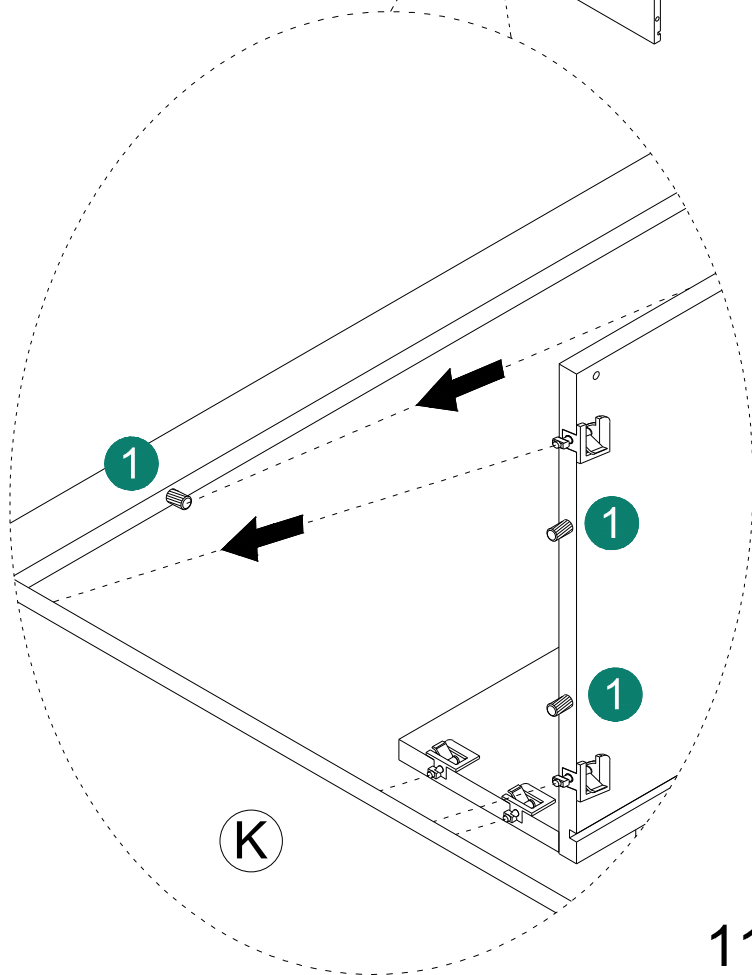
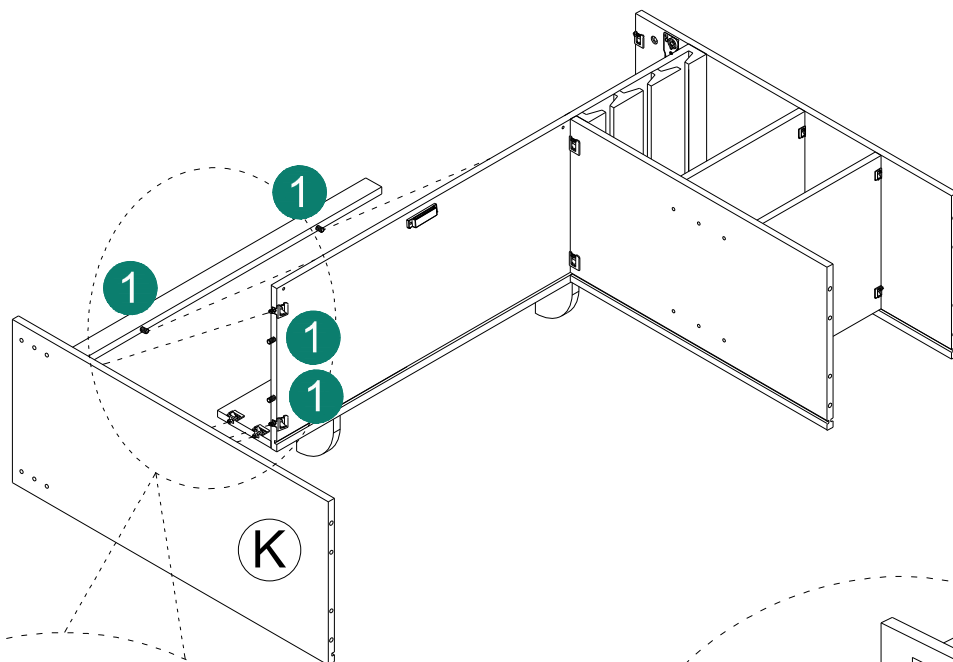

ASSEMBLY INSTRUCTIONS

7

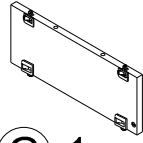

G 1pc

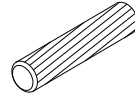

1 2pcs

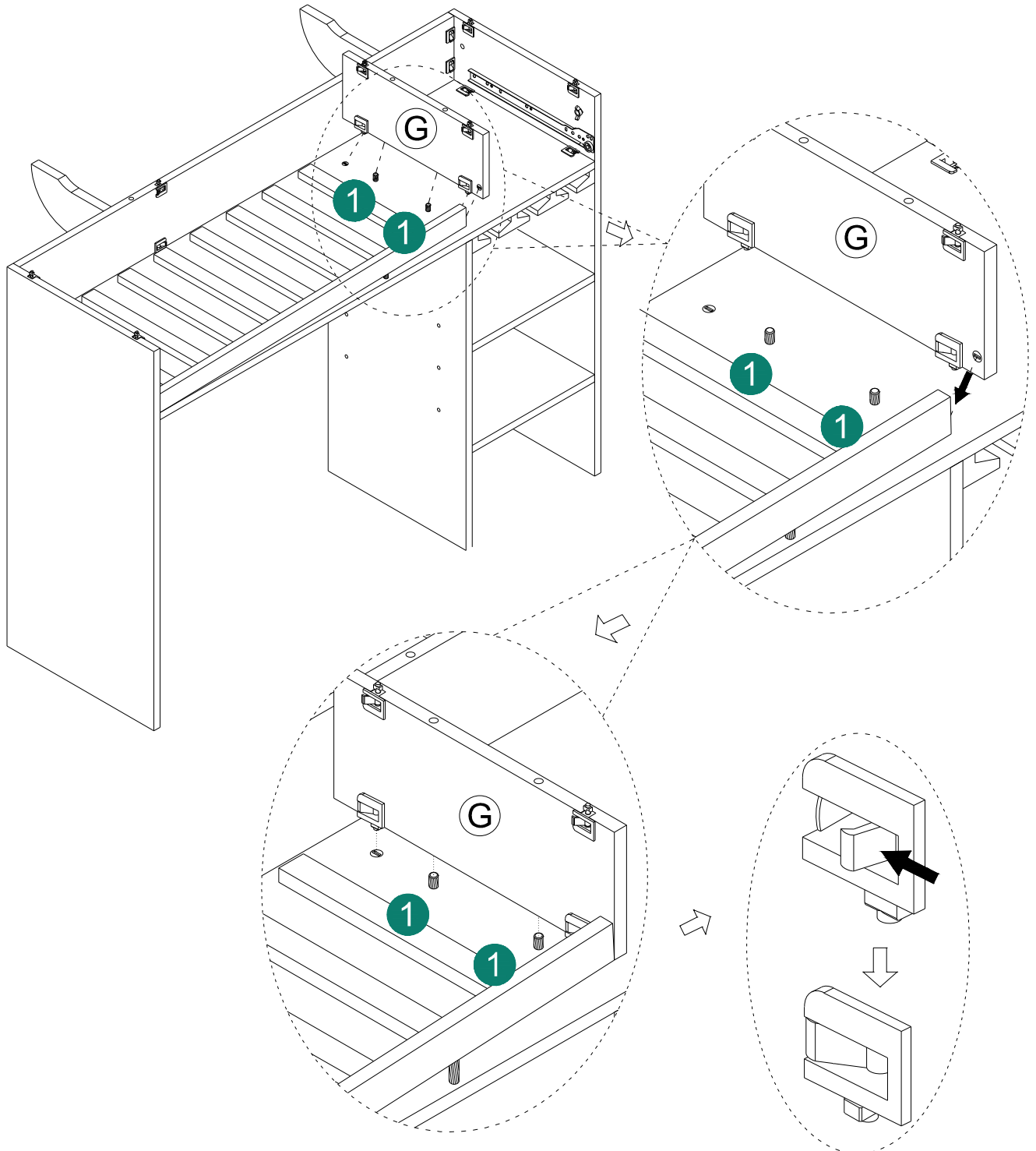

ASSEMBLY INSTRUCTIONS

8

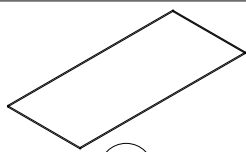

AA 2pc

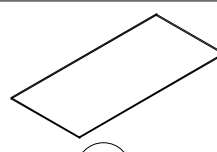

BB 1pc

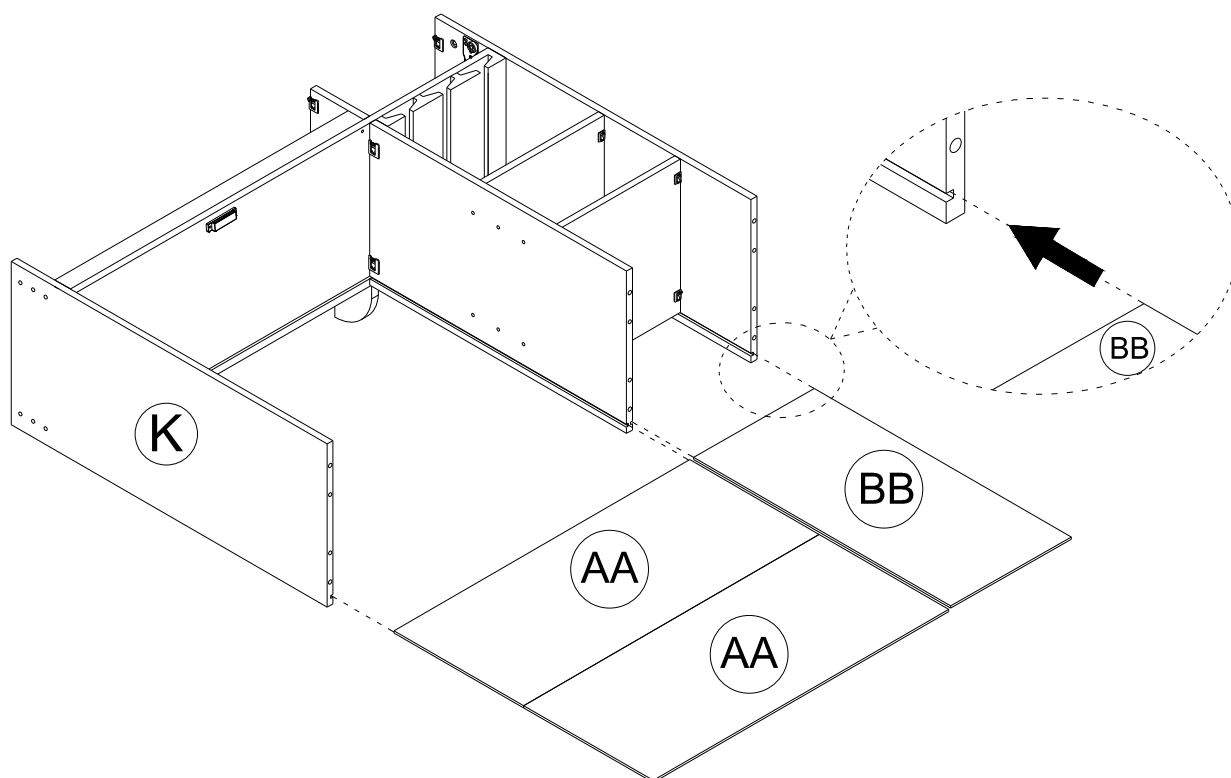

ASSEMBLY INSTRUCTIONS

9

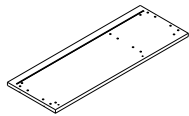

(N) 1pc



(9) 2pcs



(10) 2pcs



(11) 16pcs

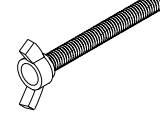

(12) 6pcs

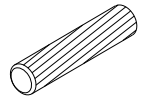

(1) 6pcs

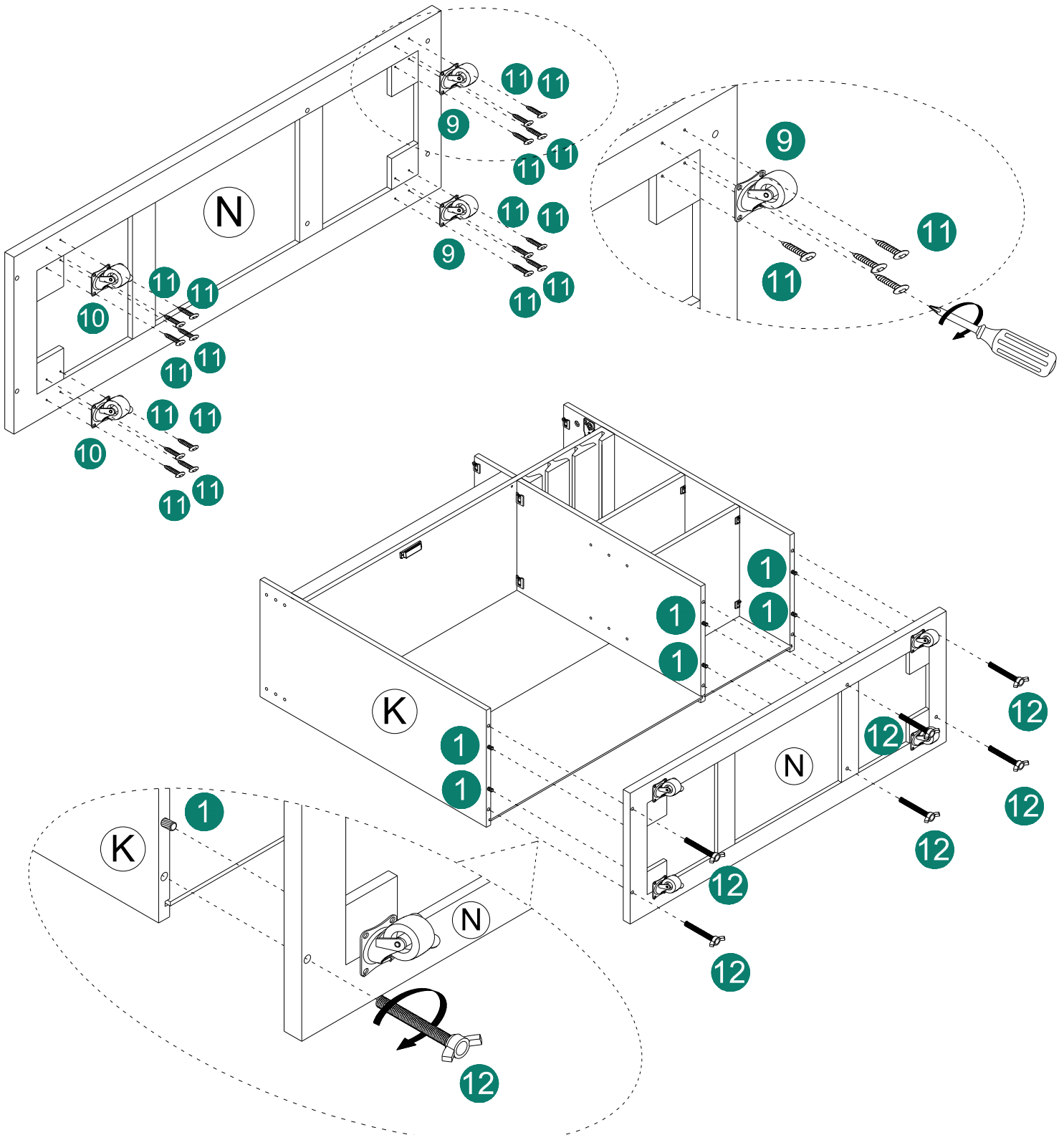

ASSEMBLY INSTRUCTIONS

10

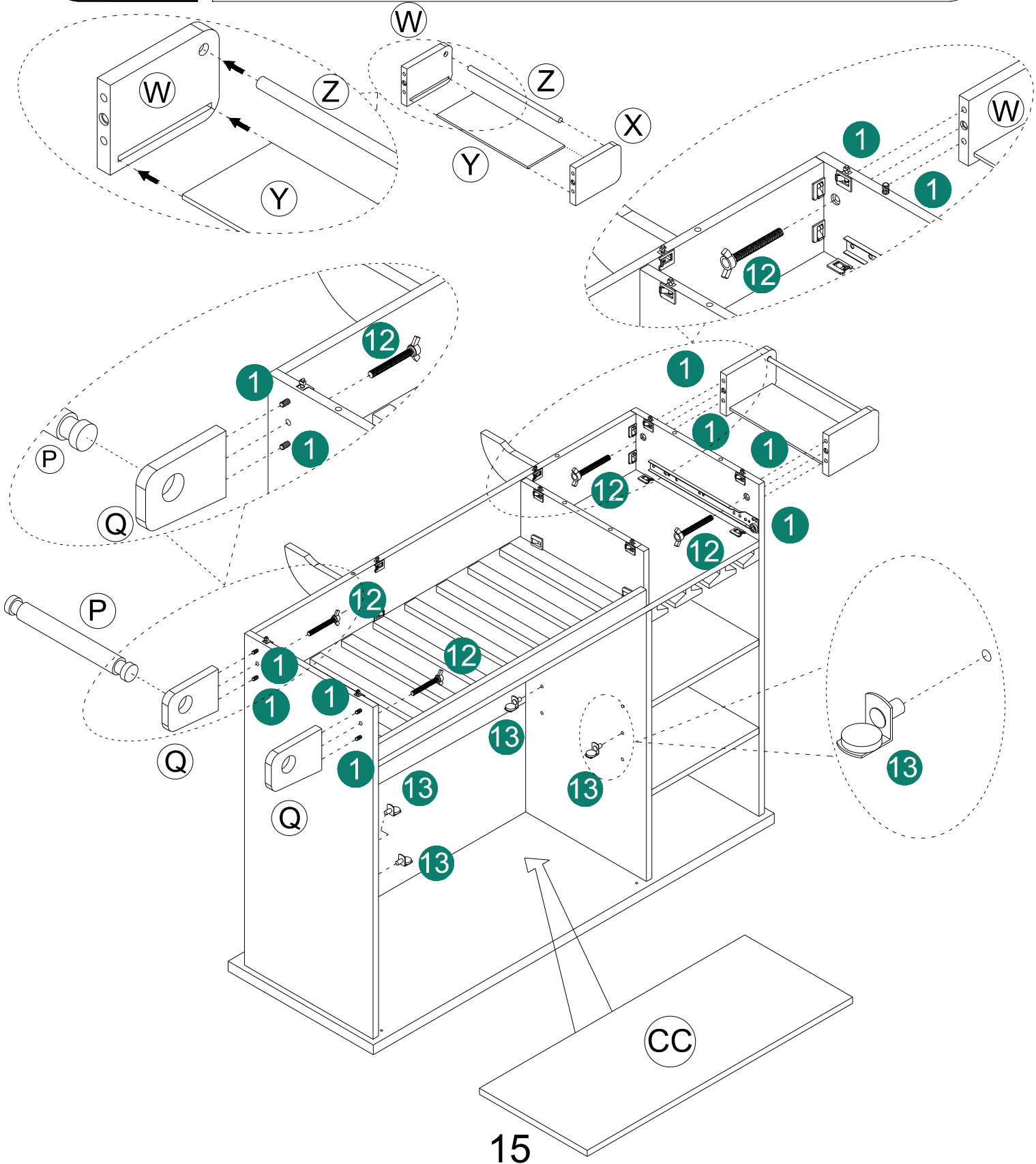
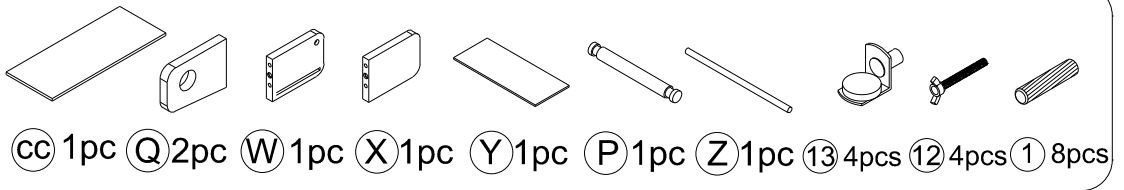

ASSEMBLY INSTRUCTIONS

11

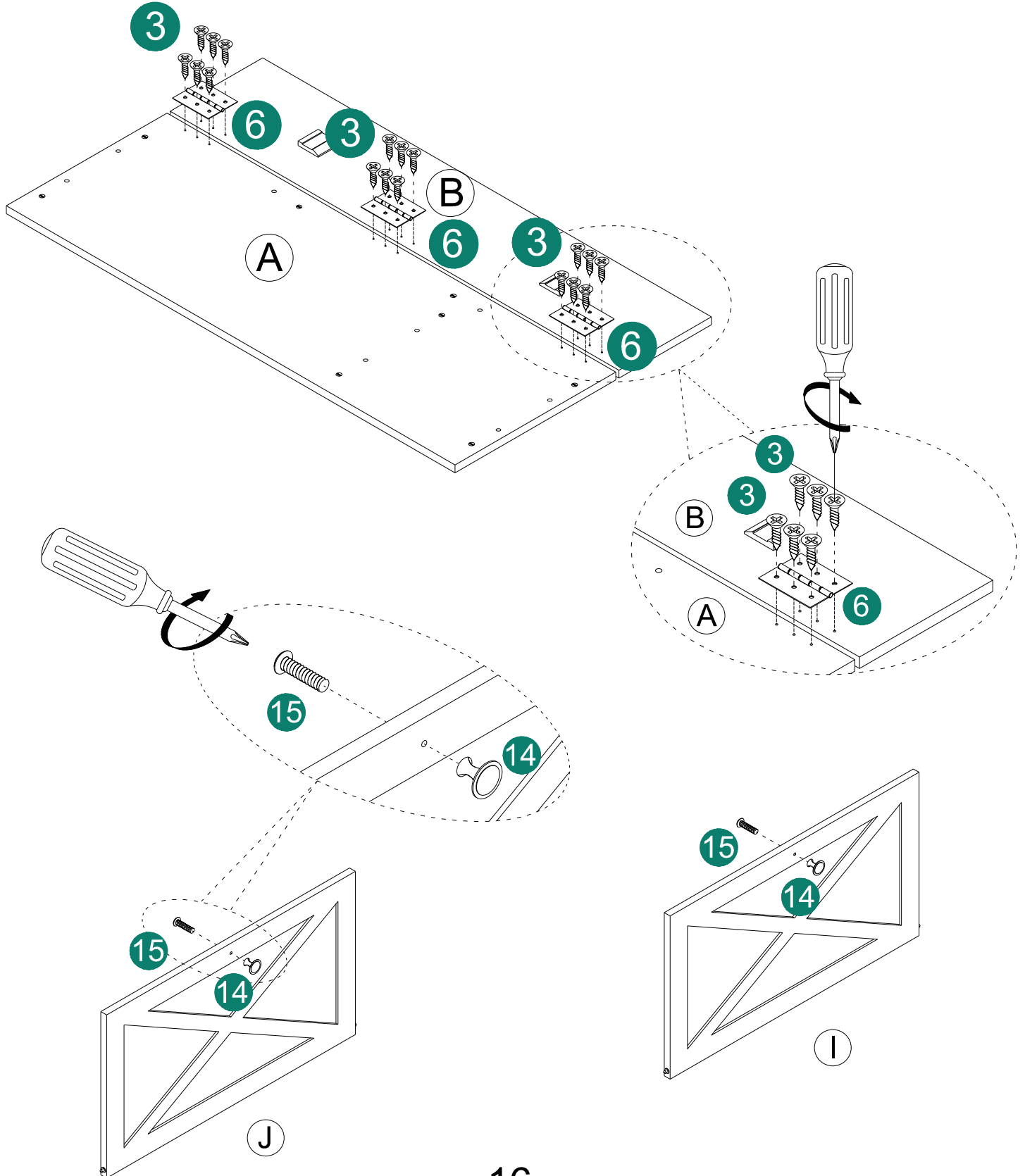
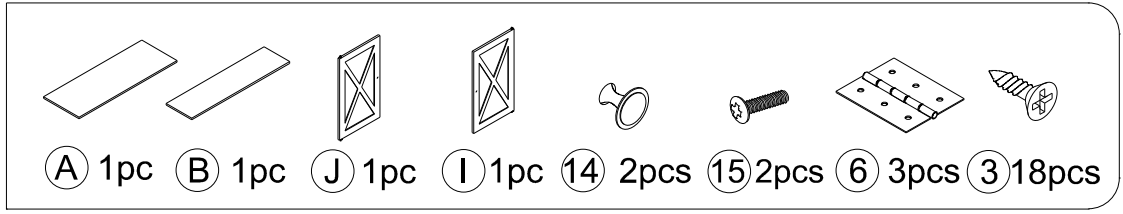

ASSEMBLY INSTRUCTIONS

12



J 1pc



I 1pc

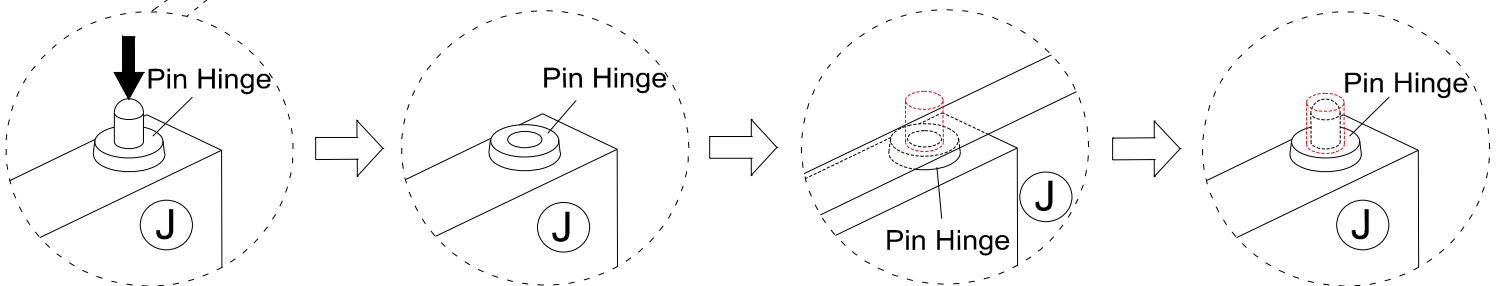
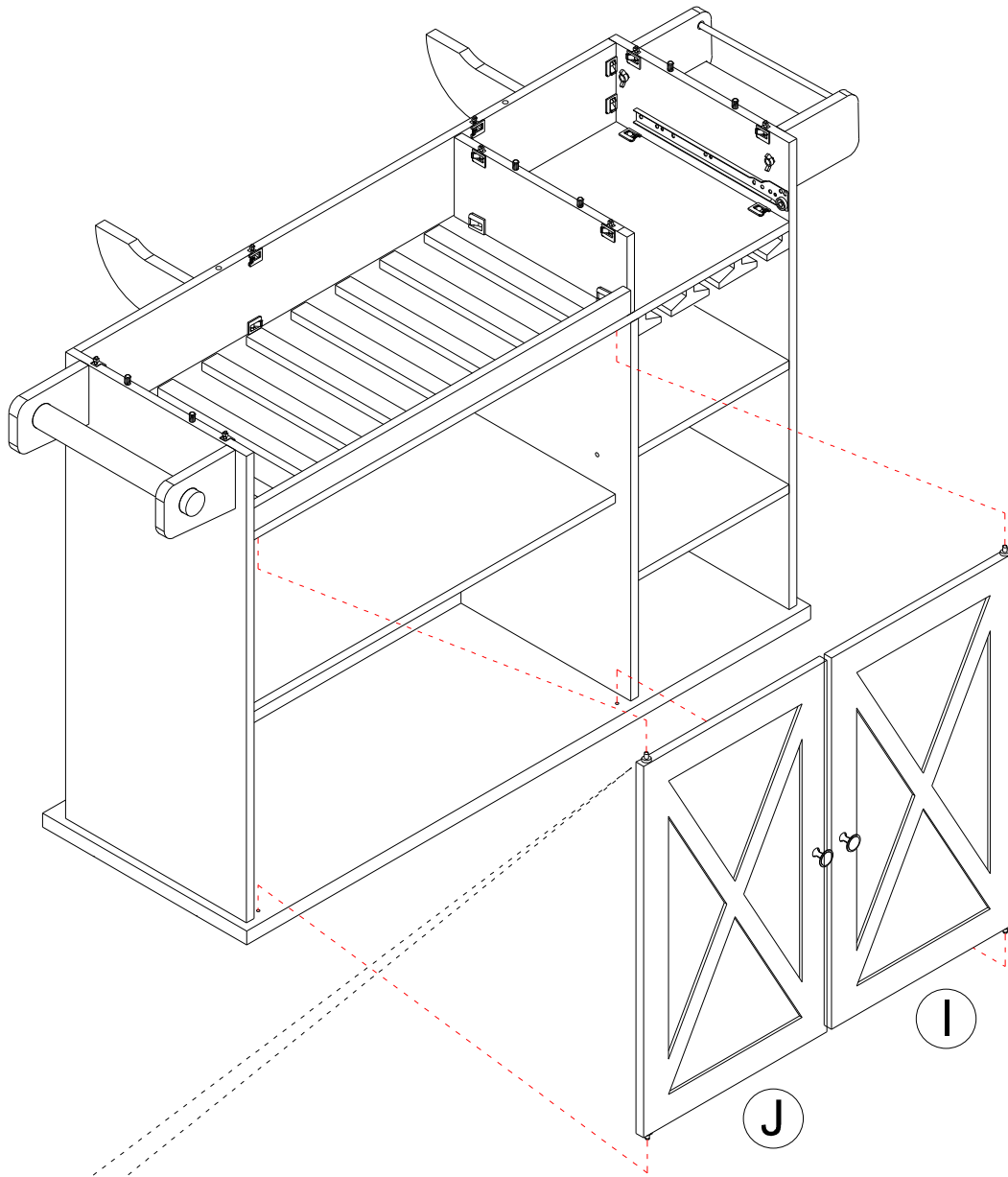

ASSEMBLY INSTRUCTIONS

13

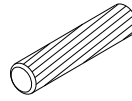

1 8pcs

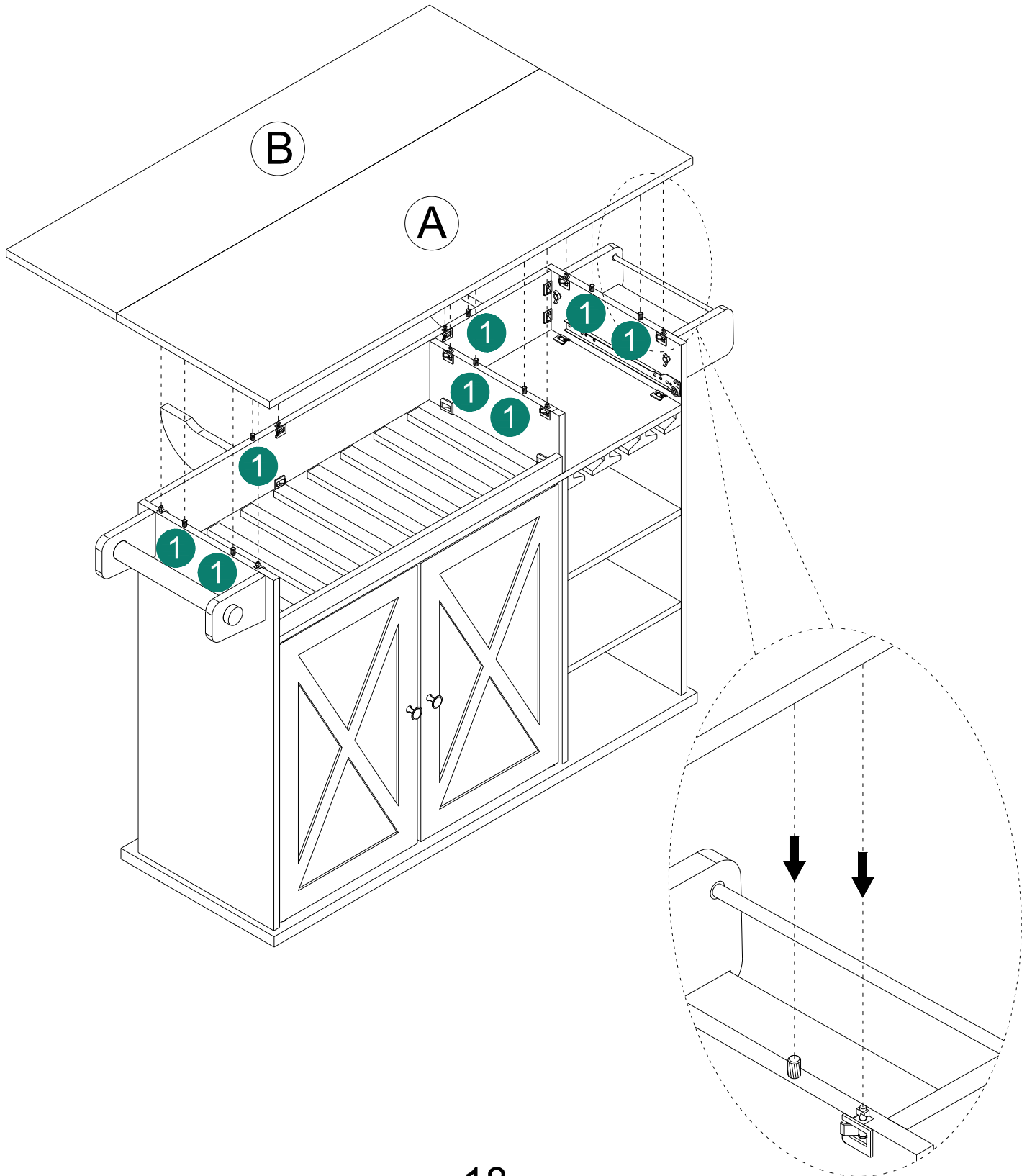

ASSEMBLY INSTRUCTIONS

14

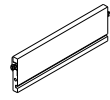

T 1pc

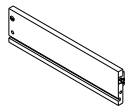

S 1pc

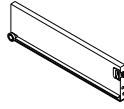

R 1pc

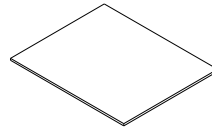

U 1pc

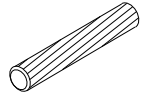

17 4pcs

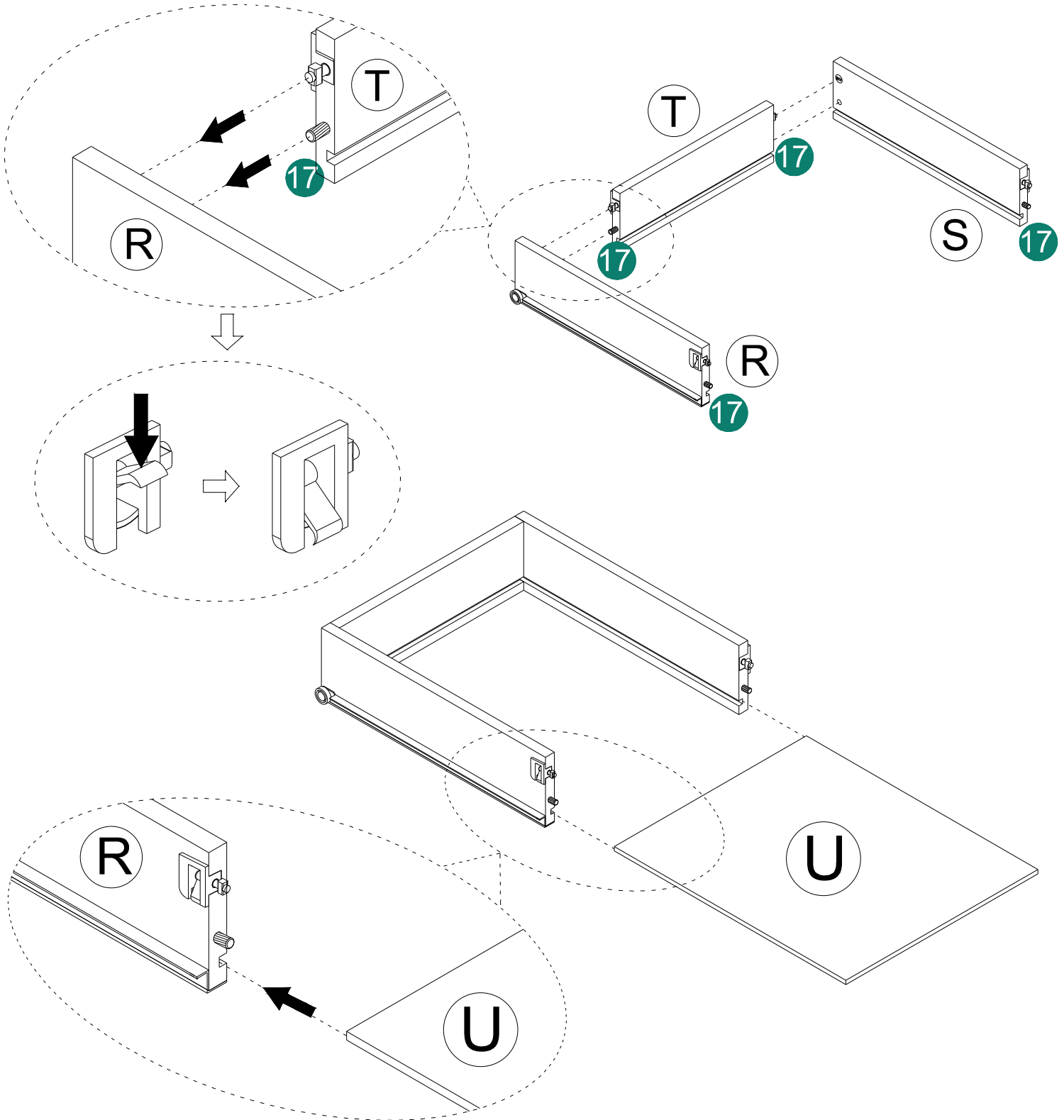

ASSEMBLY INSTRUCTIONS

15

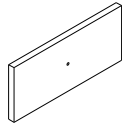

V 1pc



14 1pcs

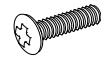

15 1pcs

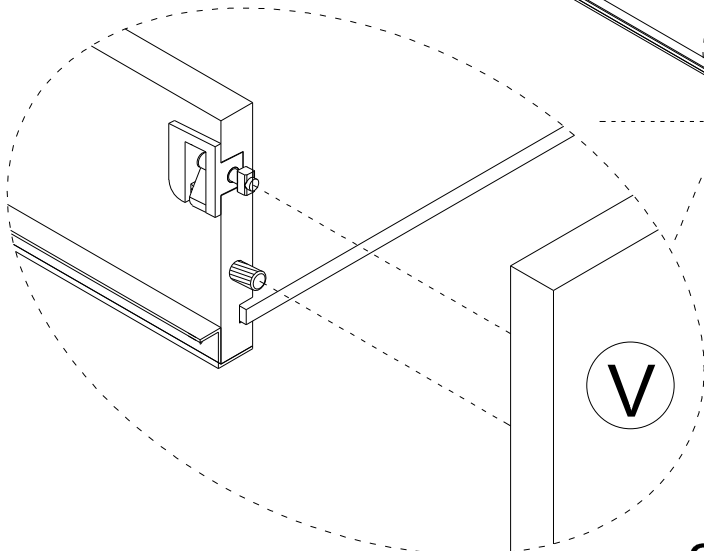
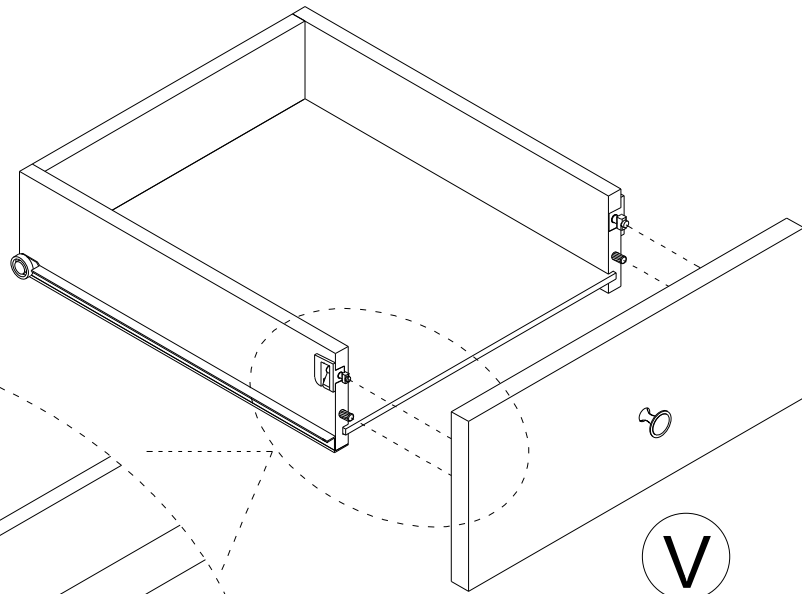
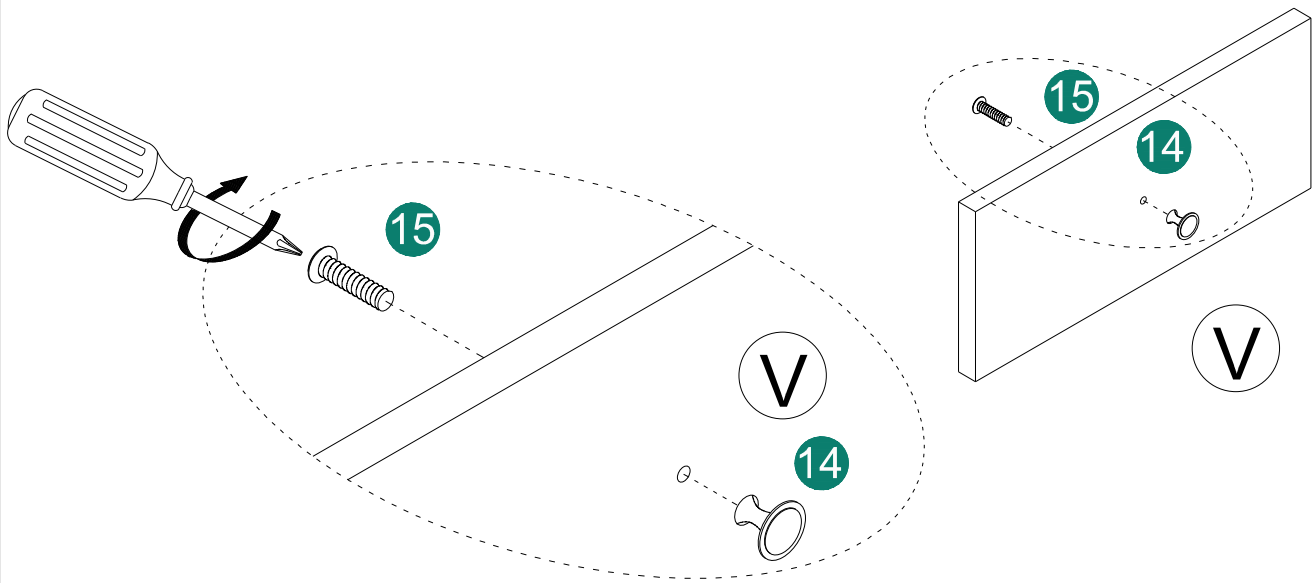

20

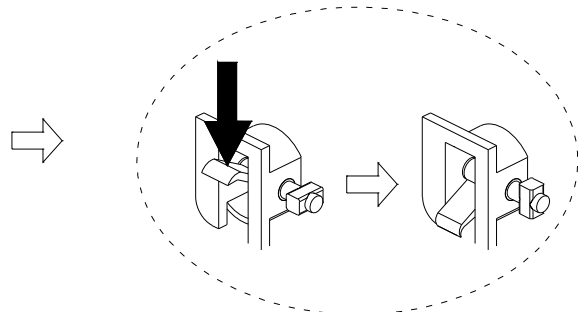

ASSEMBLY INSTRUCTIONS

16

