

CXY2332-01  
CXY2332-02

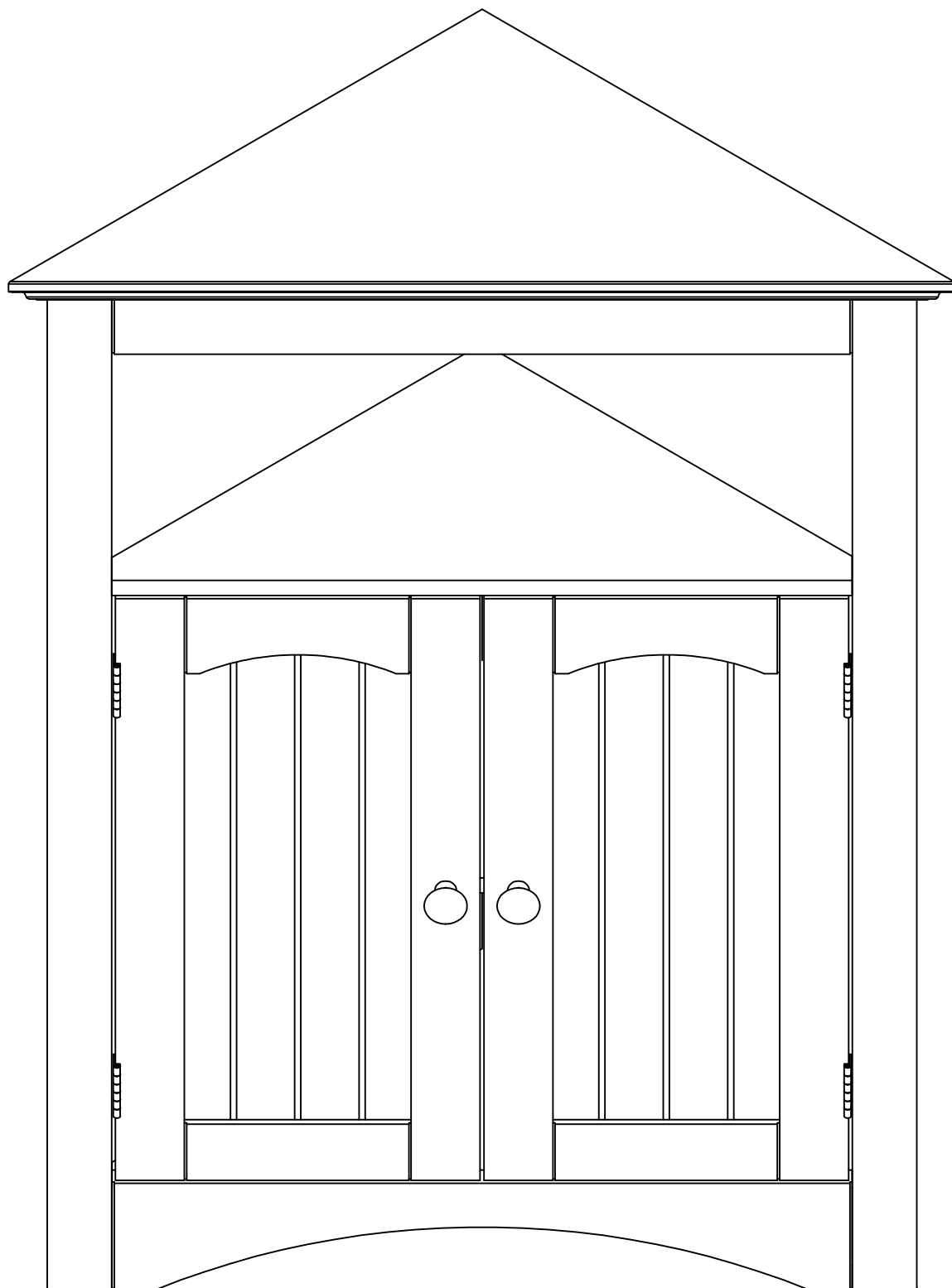

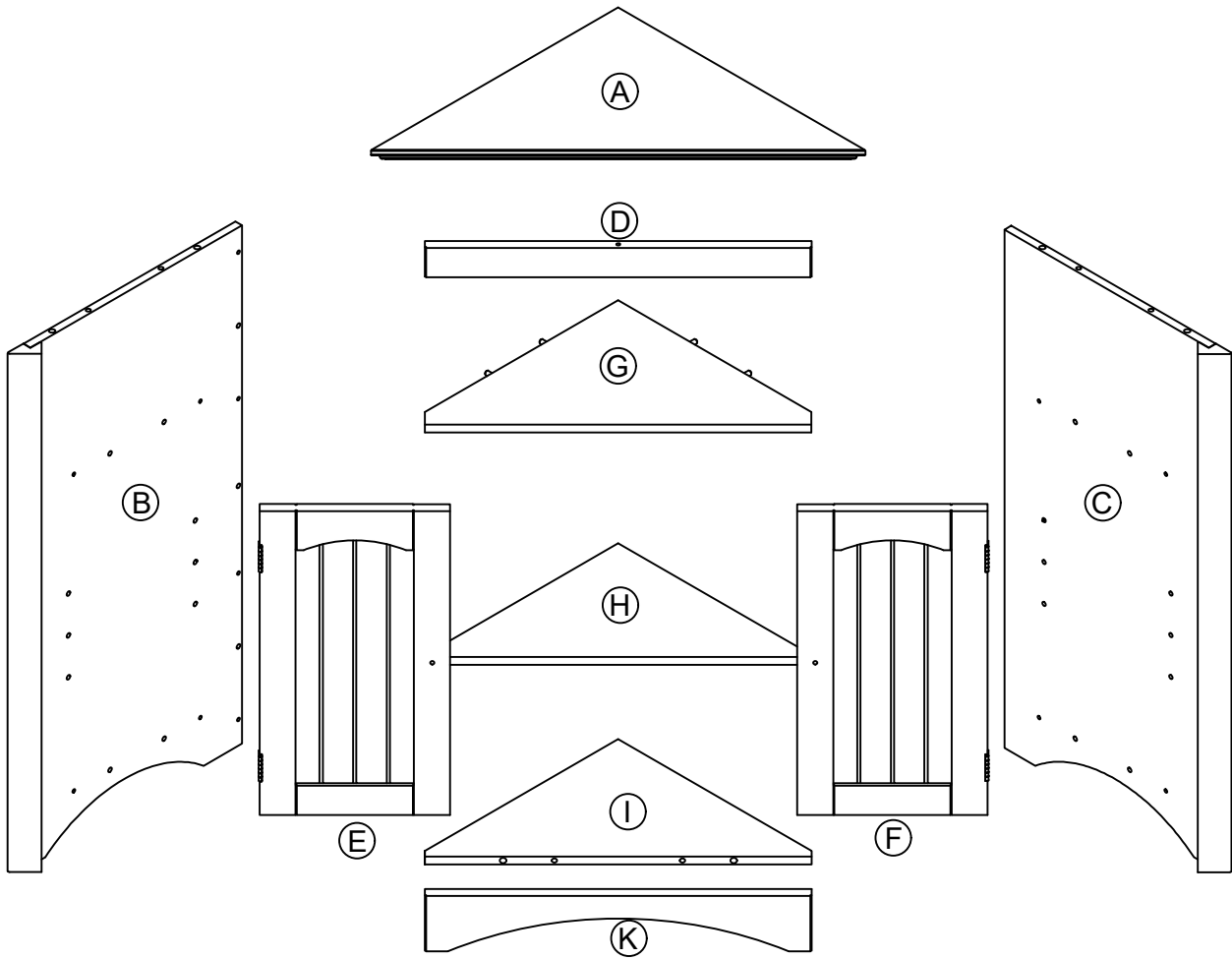







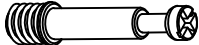

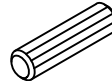

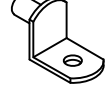
# PACKAGE CONTENTS

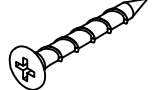

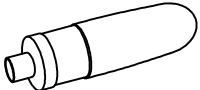
PART	DESCRIPTION	QTY		PART	DESCRIPTION	QTY
A	Top Panel	X1		F	Right Door	X1
B	Left Side Board	X1		G	Upper Shelf	X1
C	Right Side Board	X1		H	Shelf	X1
D	Front Bar	X1		I	Base Panel	X1
E	Left Door	X1		K	Base Panel Front Rail	X1

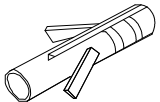
# HARDWARE CONTENTS

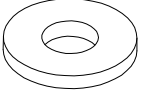

1	2	3	4
 Ø6*33mm    18PCS	 Ø15*9mm    18PCS	 Ø6*30mm    21PCS	 2PCS
5	6	7	8
 5/32"*19mm    2PCS	 4PCS	 Ø3*10mm    4PCS	 Ø4*38mm    4PCS
9	10	11	12
 Ø3*12mm    8PCS	 1PC	 Ø4*20mm    1PC	 1PC
13	14		
 1PC	 2PCS		

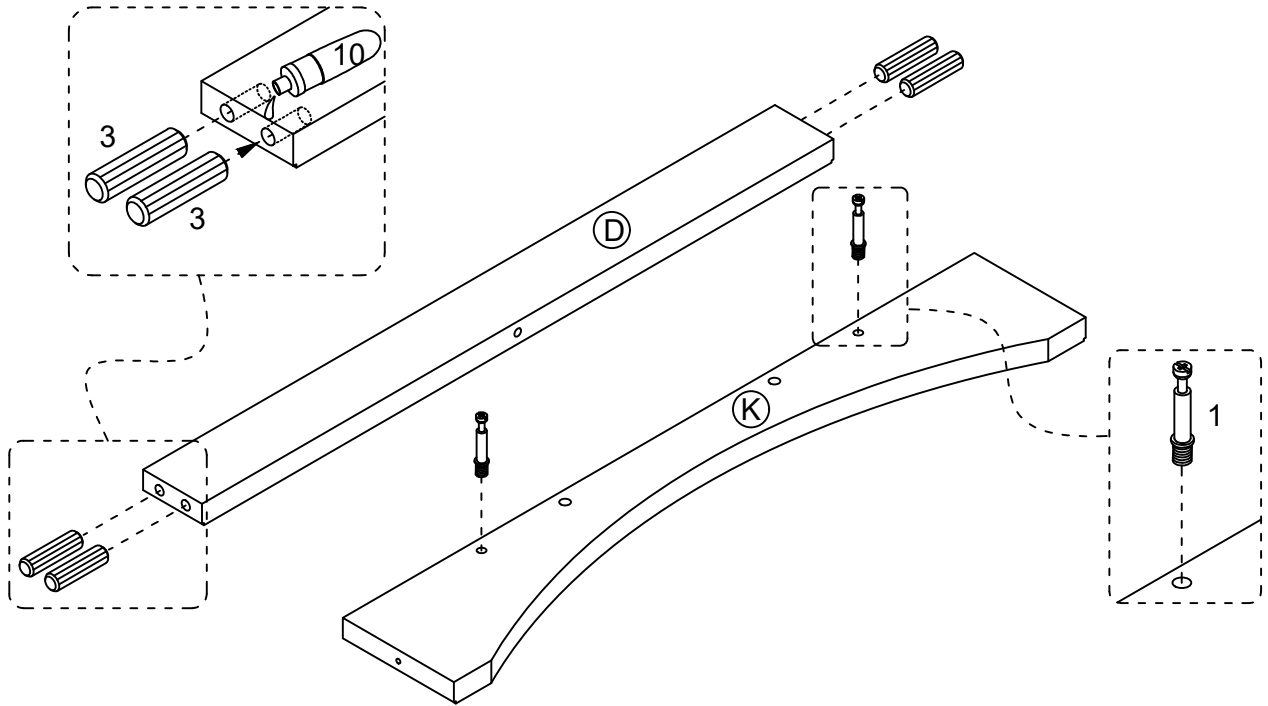
# STEP1

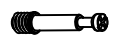

Glue the wood dowels 3 into the inner holes on the side panels D.

NOTE: It is very important to use a small amount of glue 10 on ends of dowels and wipe away excess glue immediately.

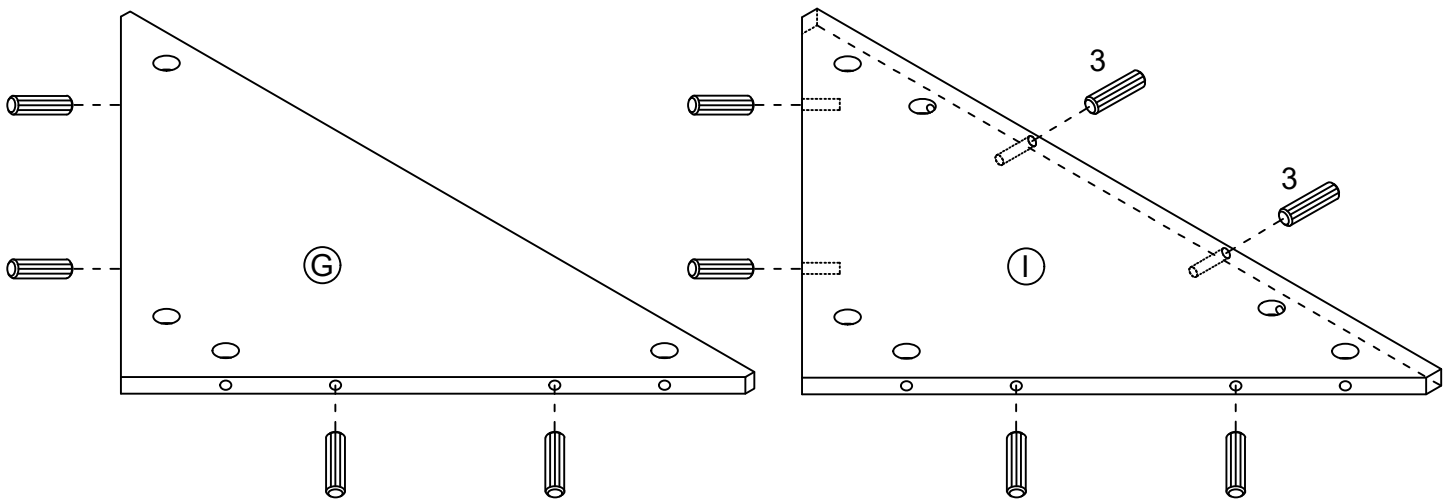
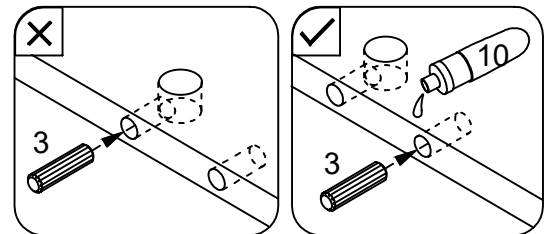

	1 x 2pcs
	3 x 4pcs
	10 x 1pc

# STEP2





Glue the wood dowels 3 into the inner holes on the front upper rail G and I .

NOTE: It is very important to use a small amount of glue 10 on ends of dowels and wipe away excess glue immediately.

	3 x 10pcs
	10 x 1pc

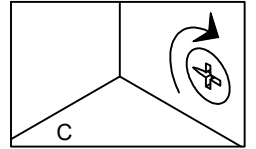
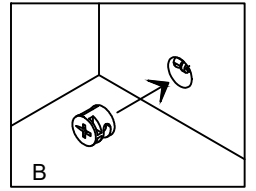
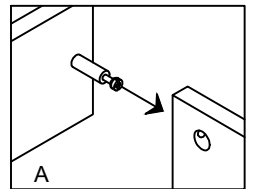
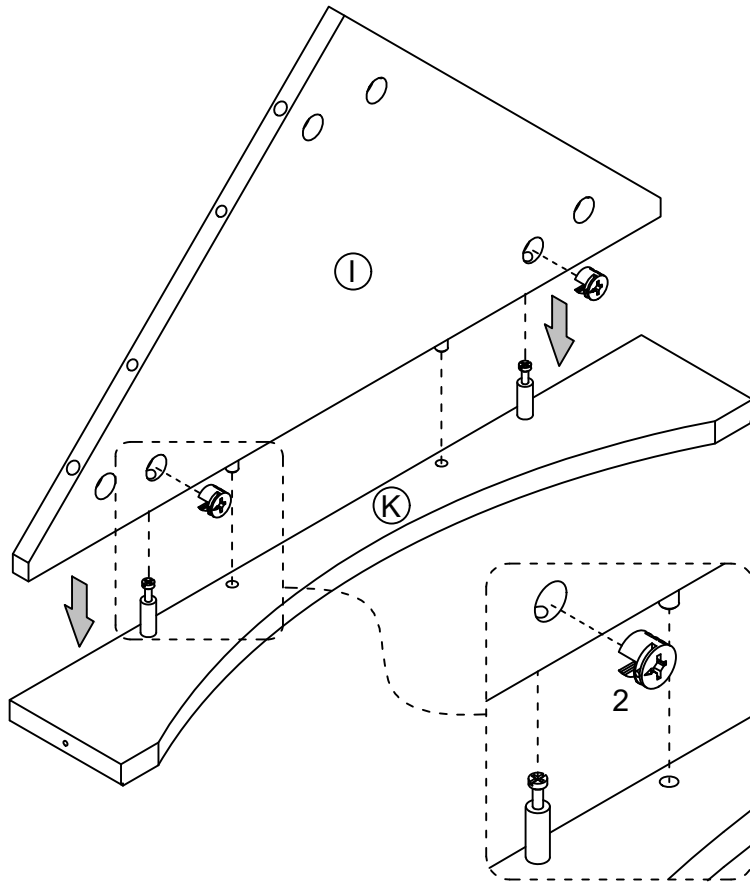
# STEP3



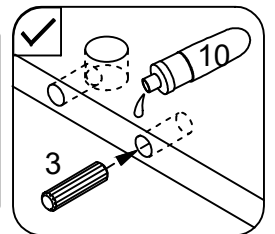
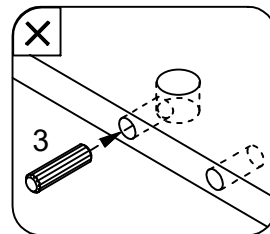
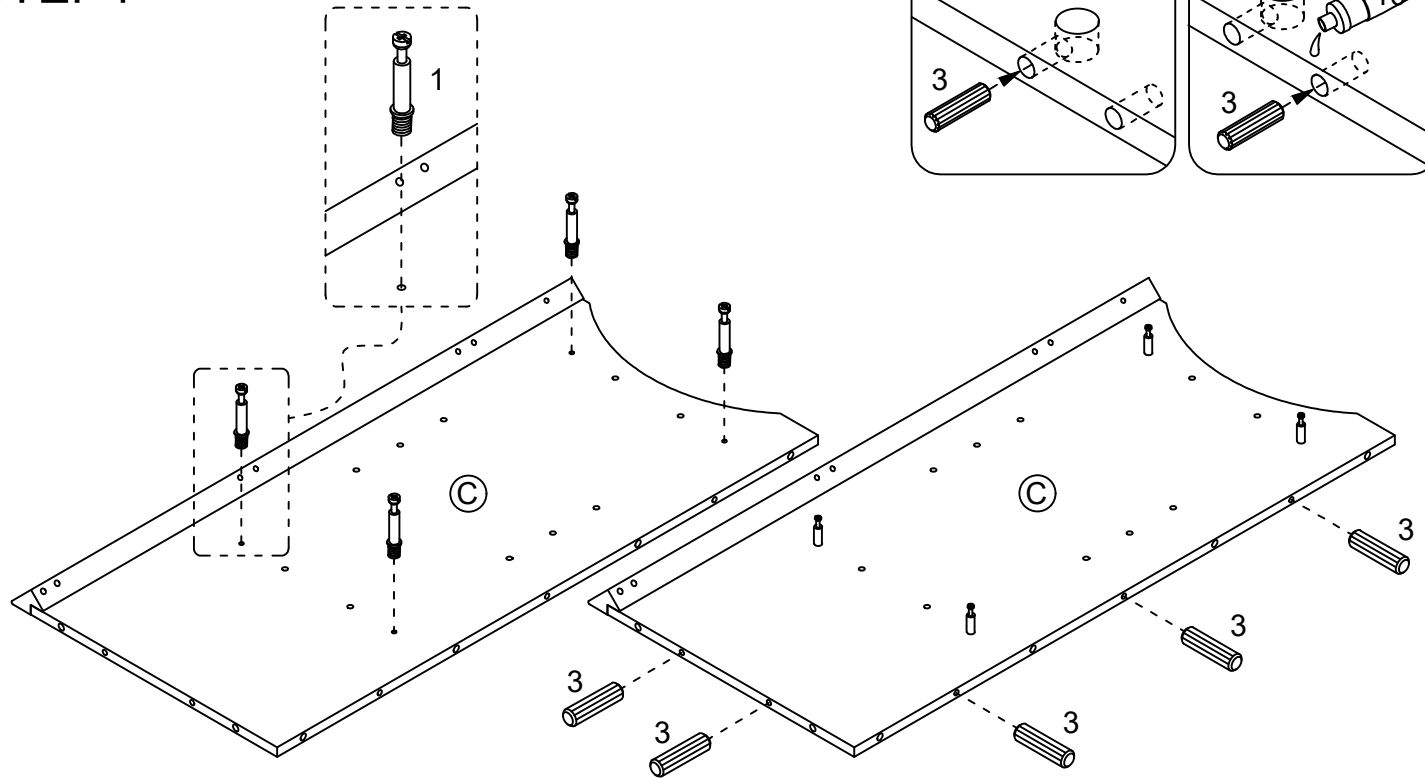

	2 x 2pcs
---	----------

# STEP4

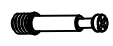

Glue the wood dowels 3 into the inner holes on the side panels C.  
 NOTE: It is very important to use a small amount of glue 10 on ends of dowels and wipe away excess glue immediately.

	1 x 4pcs
	3 x 5pcs
	10 x 1pc

# STEP5

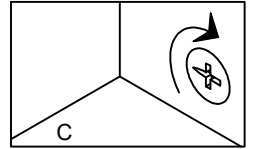
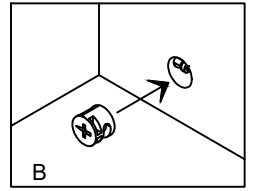
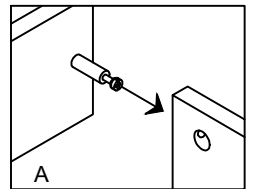
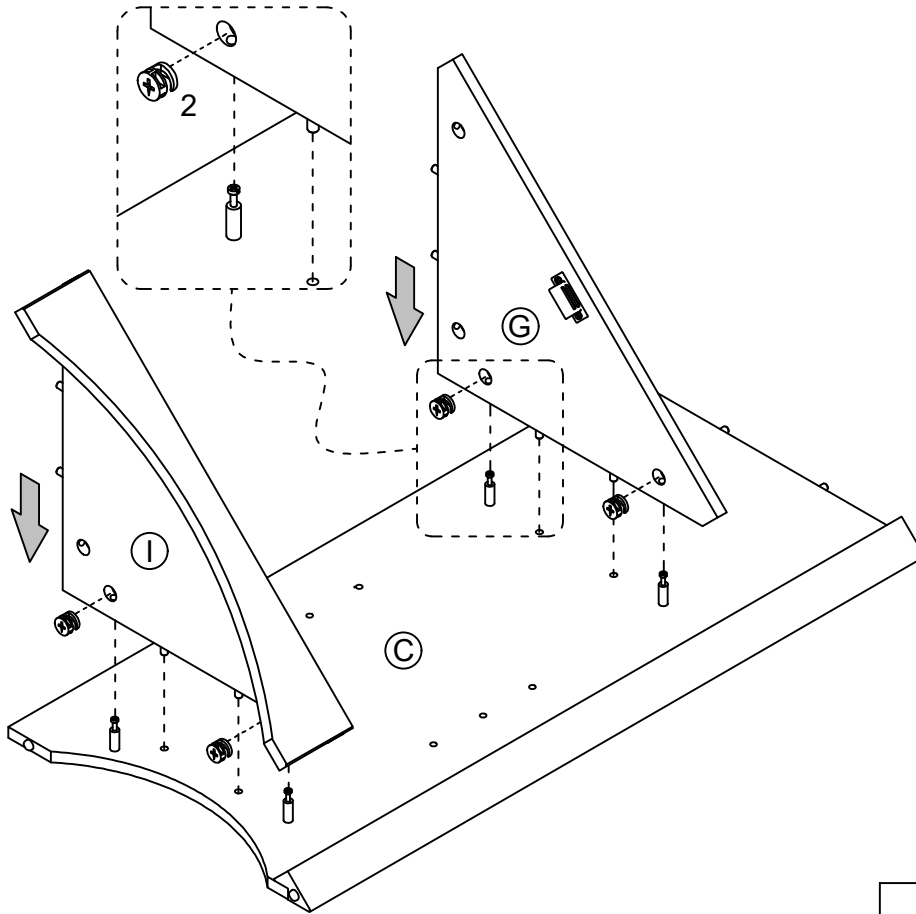

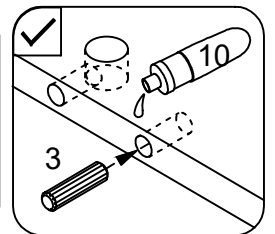
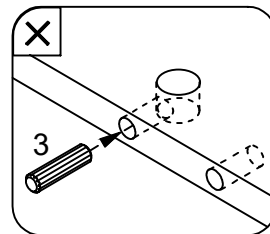
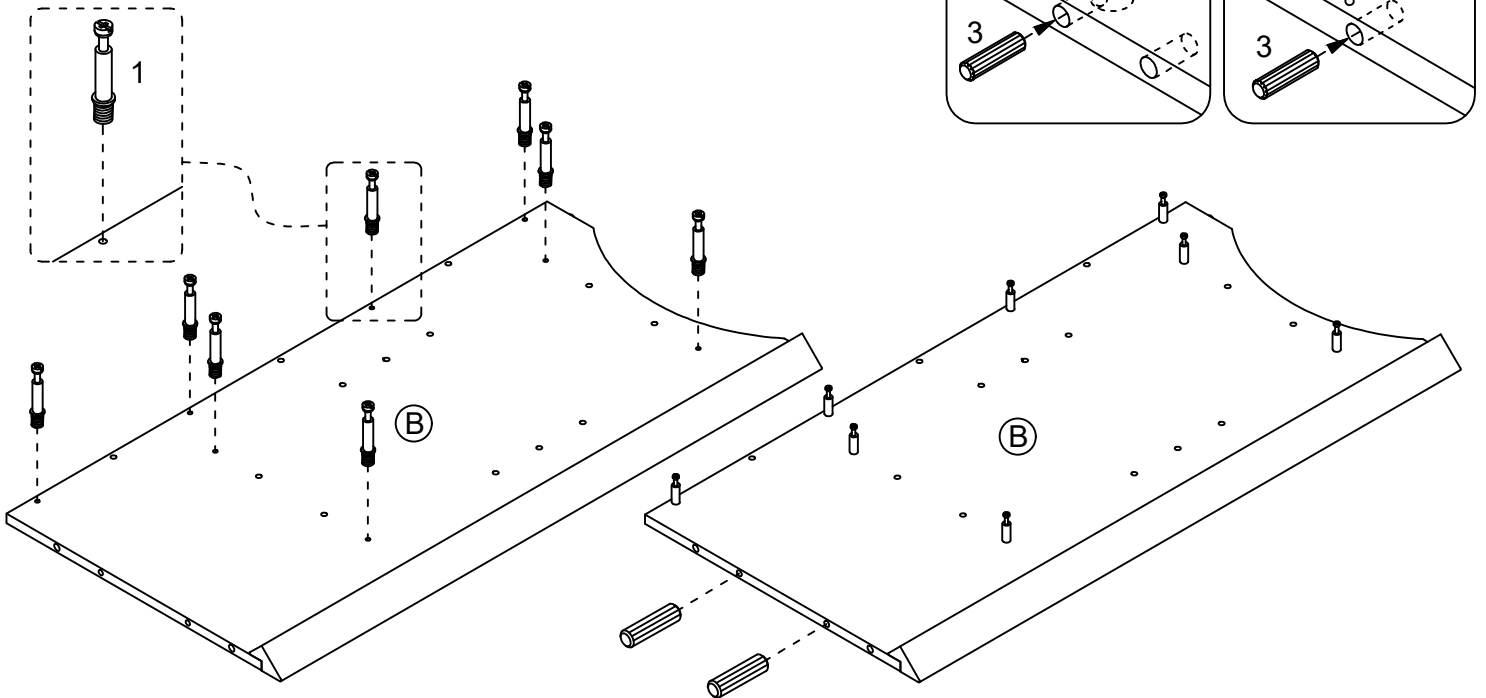

	2 x 4pcs
---	----------

# STEP6



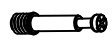

Glue the wood dowels 3 into the inner holes on the side panels B.

NOTE: It is very important to use a small amount of glue 10 on ends of dowels and wipe away excess glue immediately.

	1 x 8pcs
	3 x 2pcs
	10 x 1pc

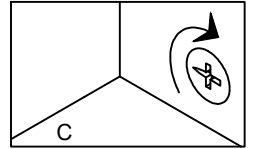
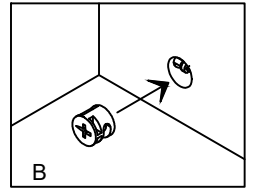
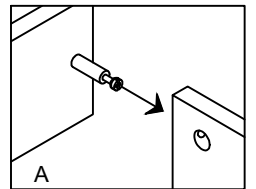
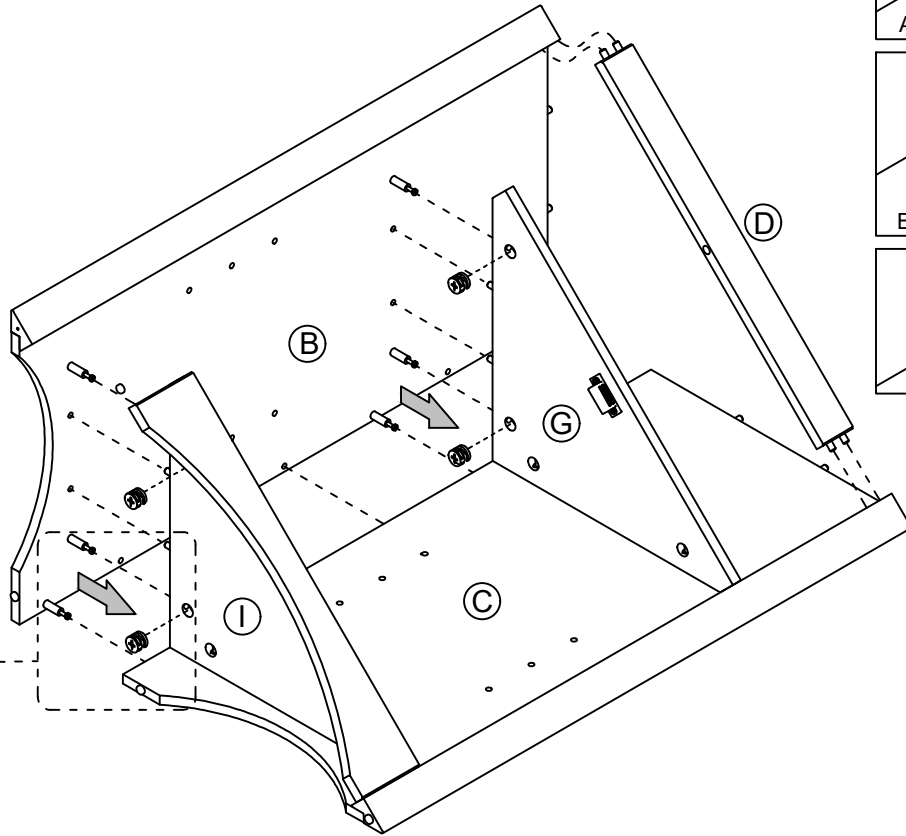
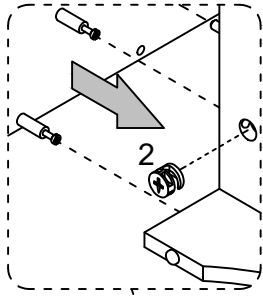

# STEP 7

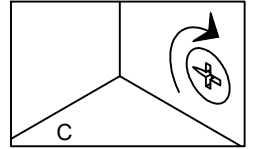
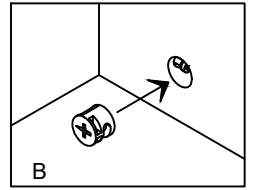
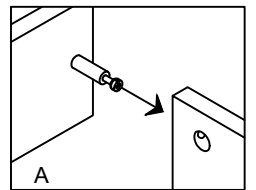
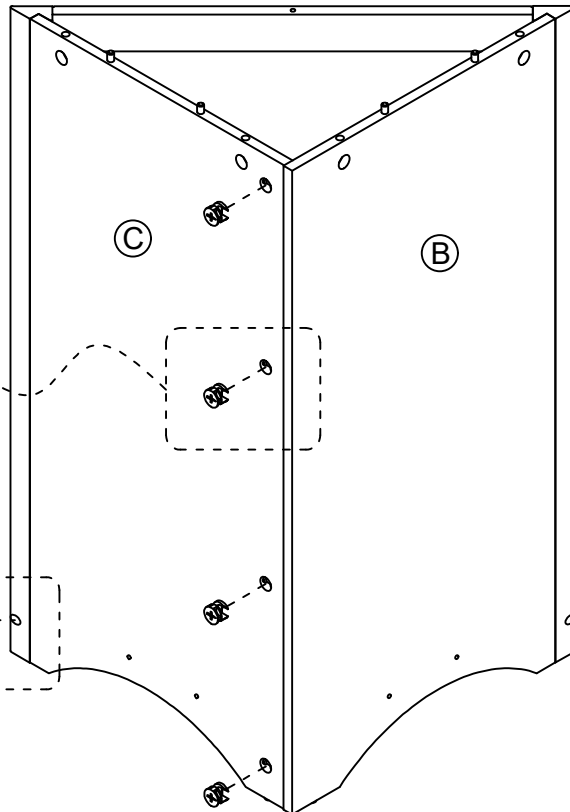
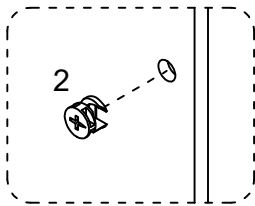

	2 x 4 pcs
---	-----------

# STEP 8



	2 x 4 pcs
	8 x 2 pcs

# STEP9

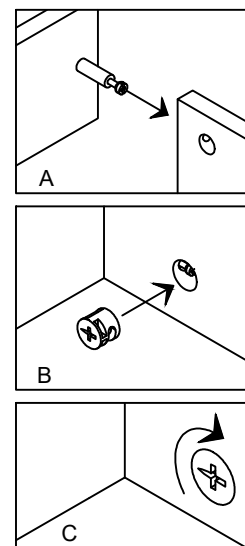
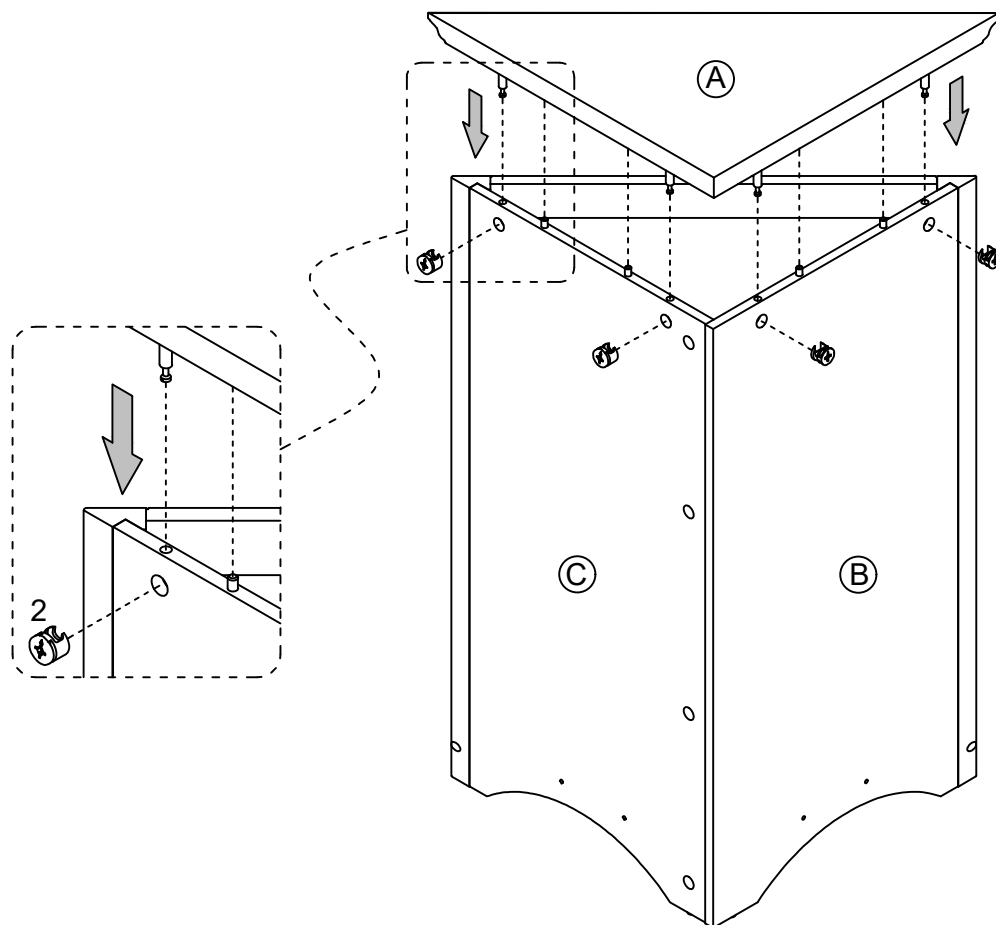

 2 x 4pcs

# STEP10

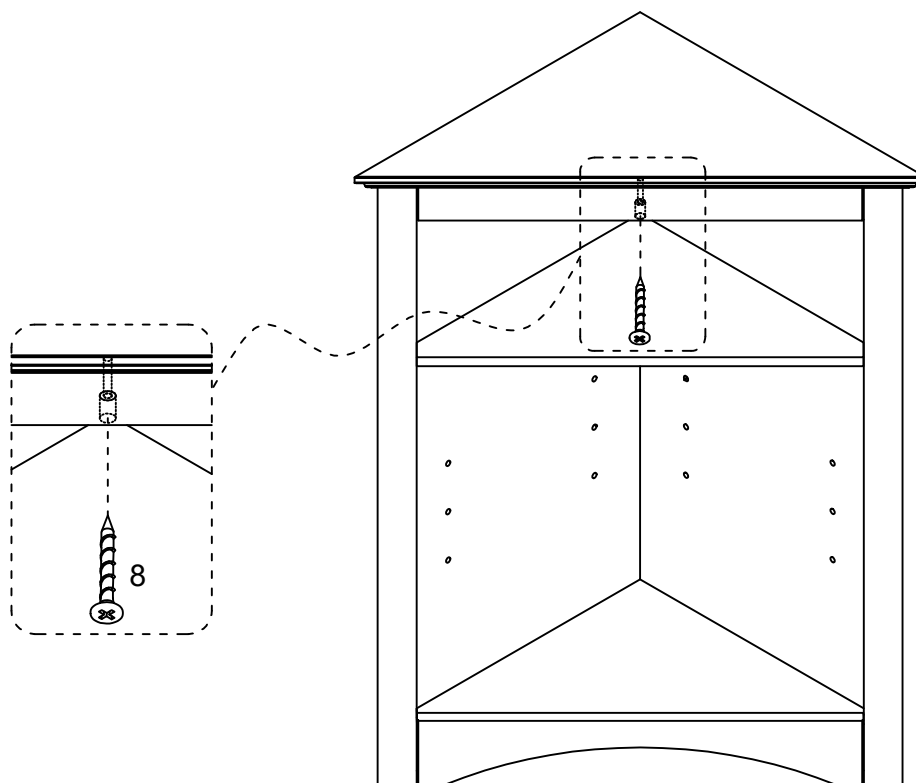

 8 x 1pc



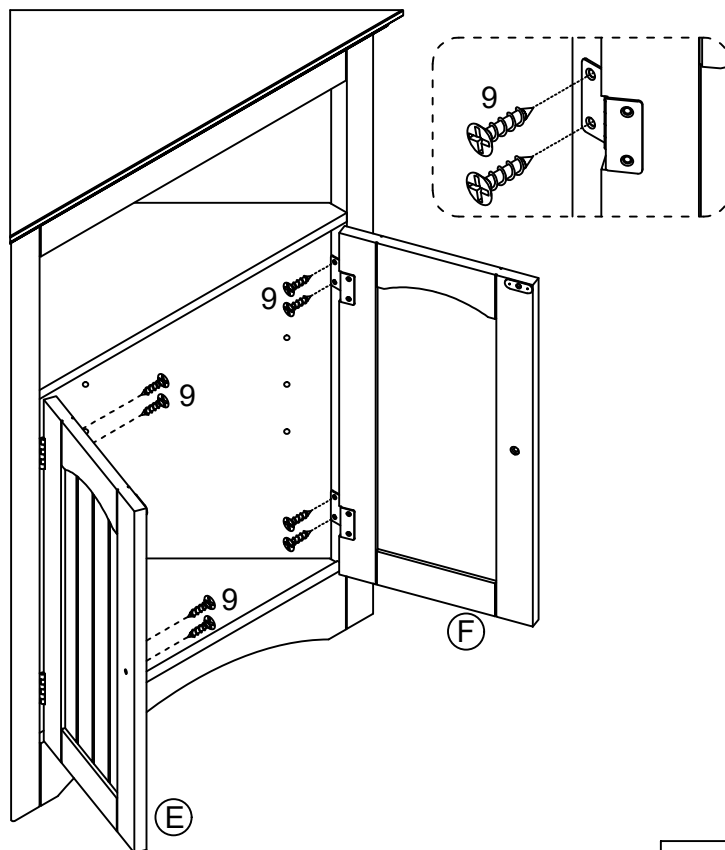

# STEP11



	9 x 8pcs
---	----------

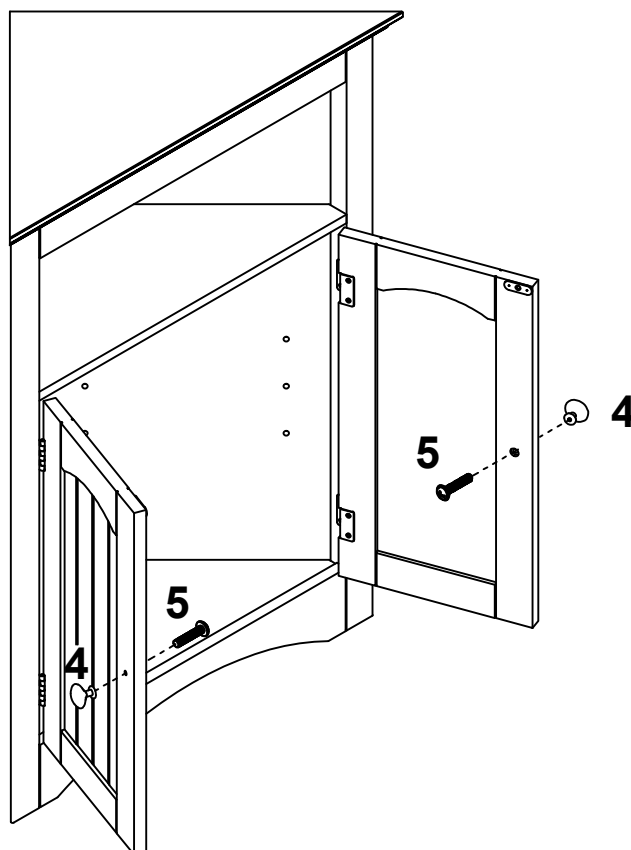

# STEP12



	4 x 2pcs
	5 x 2pcs

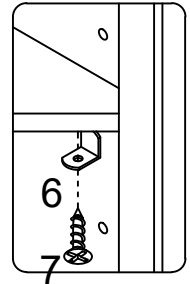
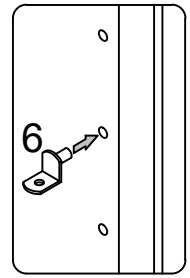
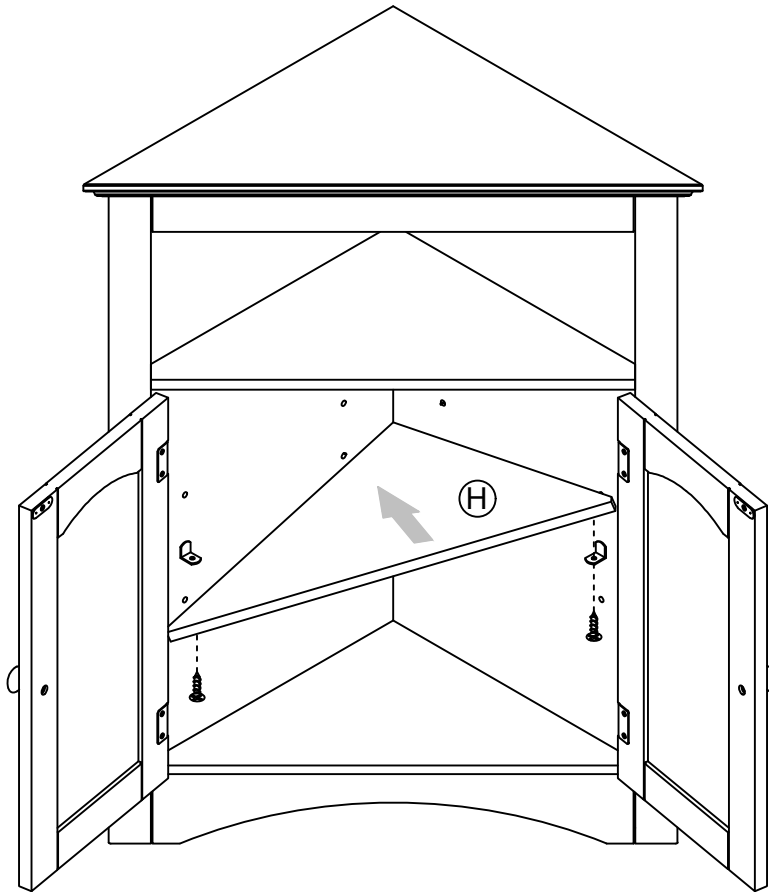



# STEP13

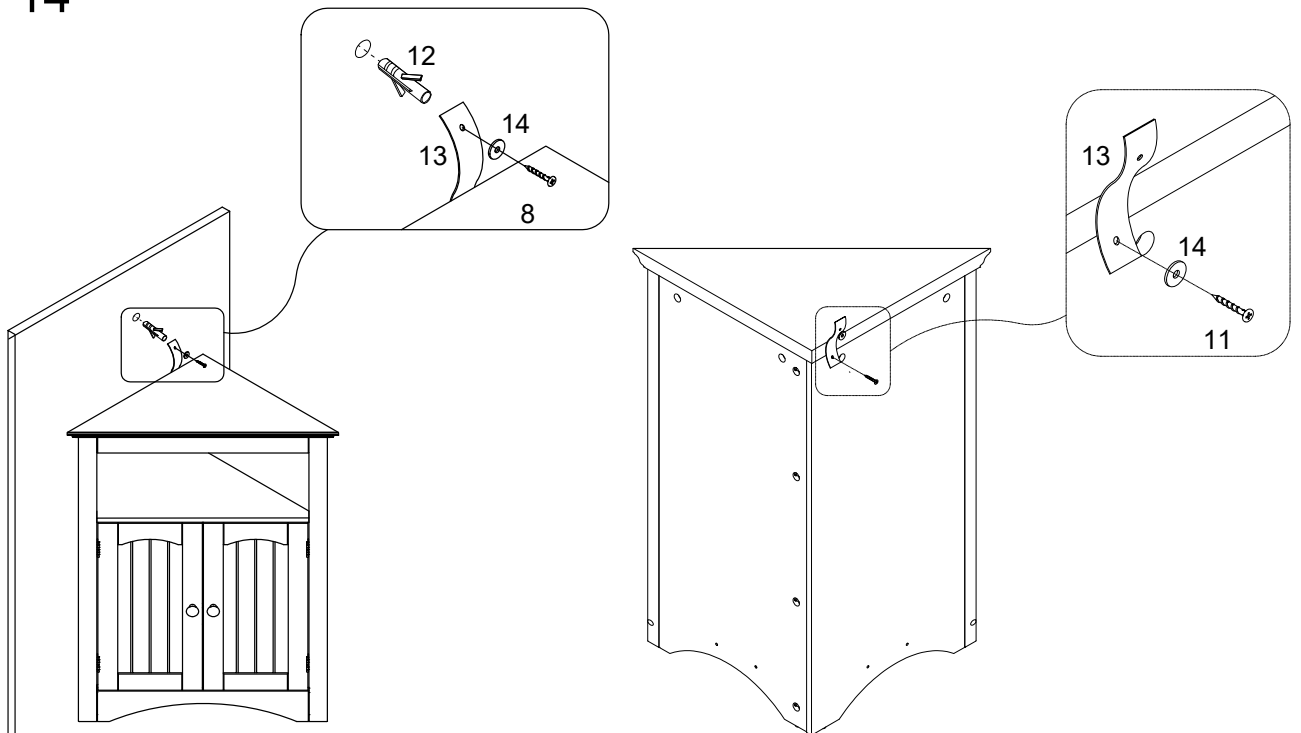

	6 x 4pcs
	7 x 4pcs

# STEP14



8		1pc
11		1pc
12		1pc
13		1pc
14		2pcs