

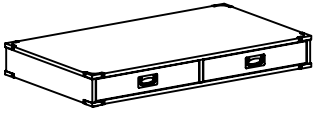

# ASSEMBLY INSTRUCTION

## E581A BOX DESK WITH X LEG

<b>A</b> WOOD TOP WITH DRAWER  1 PC	<b>B</b> RIGHT LEG  1 PC	<b>C</b> LEFT LEG  1 PC	<b>D</b> POST  1 PC
<b>E</b> PLUG  2 PCS	<b>F</b> WOOD DOWEL Ø8,28mm  4 PCS	<b>G</b> BOLT 1/4",28MM  4 PCS	<b>H</b> BOLT 1/4",38MM  2 PCS
<b>I</b> FLAT WASHER 1/4",16MM  4 PCS	<b>J</b> FLAT WASHER 1/4",13MM  2 PCS	<b>K</b> LOCK WASHER  6 PCS	<b>L</b> ALLEN WRENCH  1 PC

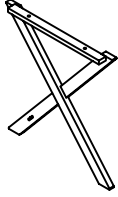
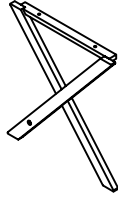
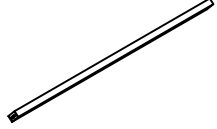
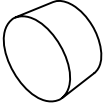
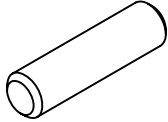
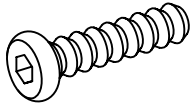
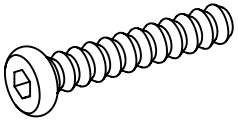
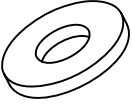

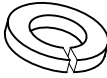
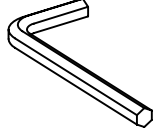
This page lists all the contents included in the box. Please take the time to identify the hardware as well as the individual components to this product. As you unpack and prepare for assembly, place the contents on a carpeted or padded area to protect them from damage.

- 1** Attached Post (D) to the Legs (B / C). Use Wood dowel (F), Bolt (H), Lock Washer (K) and Flat Washer (J), on holes of Legs (B / C). Turn the Allen Wrench (L) in Bolt (H). Cover the holes of Legs (B / C) use Plug (E) in last.

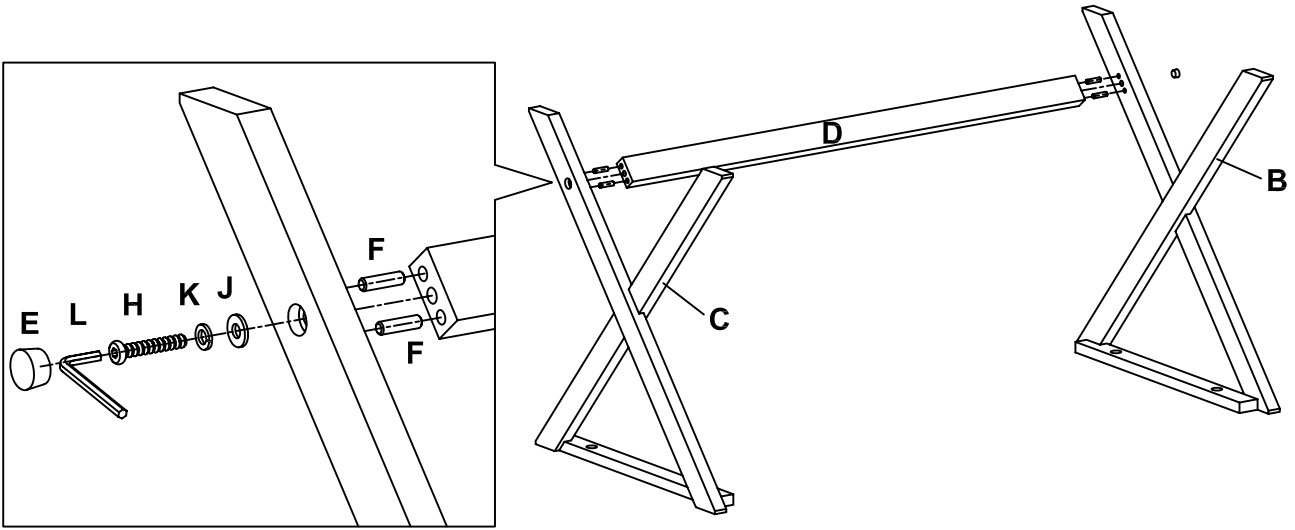

- 2** Attached the Legs (B / C) to the Table Top (A). Use Bolt (G), Lock Washer (K) and Flat Washer (I), on holes of Legs (B / C). Turn the Allen Wrench (L) in Bolt (G).

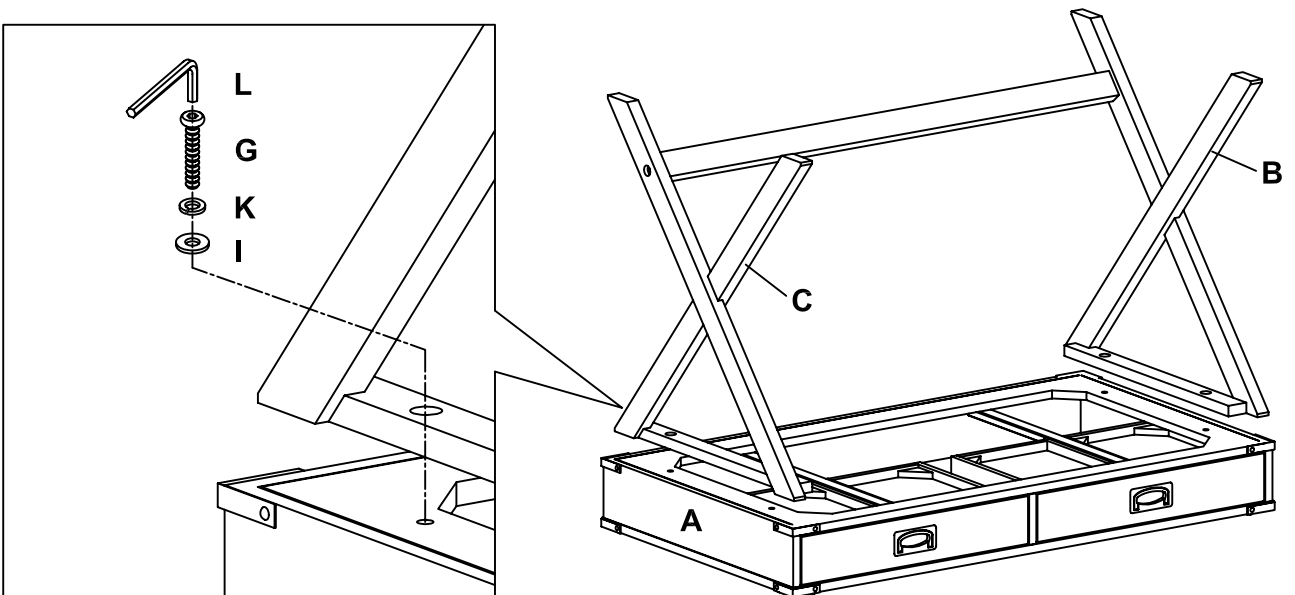

### Cleaning & Care

Treat surface with care. Surface is resistant to scratches but is not scratch resistant. Clean surface with a dry or damp soft cloth. Do not use abrasive cleaners. Hardware may loosen over time. Periodically check that all connections are tight.