

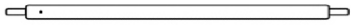

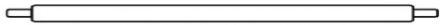

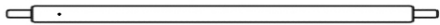





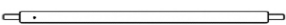

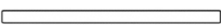

IMPORTANT, RETAIN FOR FUTURE REFERENCE: READ CAREFULLY

## ASSEMBLY & INSTRUCTION MANUAL

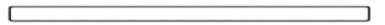
	<b>1</b> x 4 1320
	<b>2</b> x 12 1825
	<b>2A</b> x 4 1825
	<b>3</b> x 6 970
	<b>3A</b> x 4 970
	<b>4</b> x 4 1858
	<b>5</b> x 1 1830
	<b>5A</b> x 1 1830
	<b>6</b> x 1 605
	<b>7</b> x 10 1115
	<b>8</b> x 5 1115
 Φ16 395mm	<b>10</b> x 8 395
	<b>A</b> x 2 1700
	<b>C</b> x 2 497
	<b>B</b> x 1 1845

**HARDWARE**

**D** x 4



**E1** x 2



**E2** x 2



**F** x 7



**G** x 1



**H** x 6



**I** x 22



**J** x 2



**K** x 35



M6  
+1(spare)

**L** x 6



M8  
+1(spare)

**M** x 1

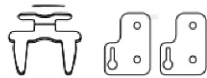

**O** x 2

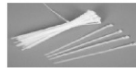

**P** x 2



**Q** x 1

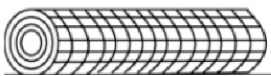

**R** x 32



**S** x 1



**T** x 2



**U** x 6

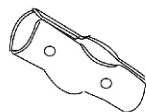

**W** x 12

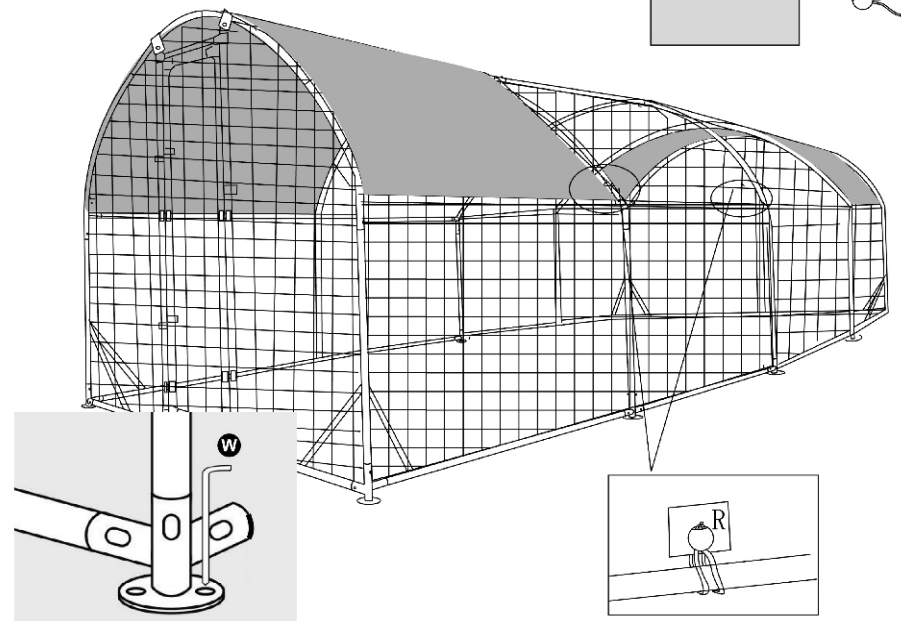
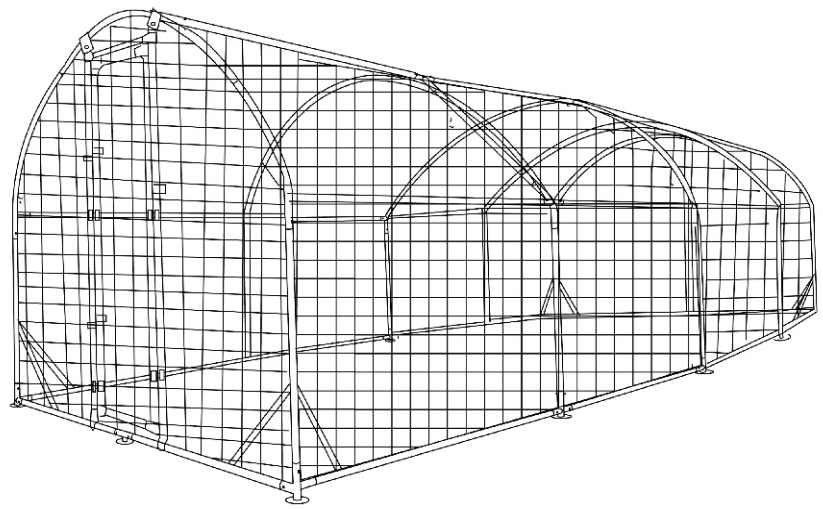
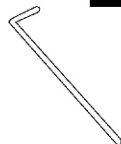

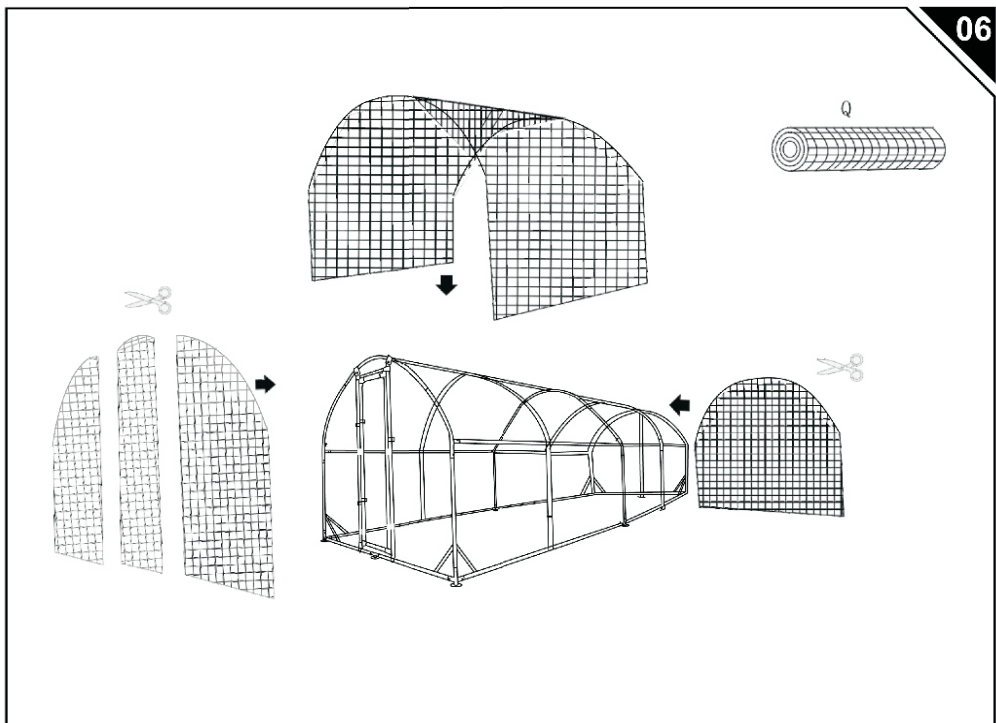
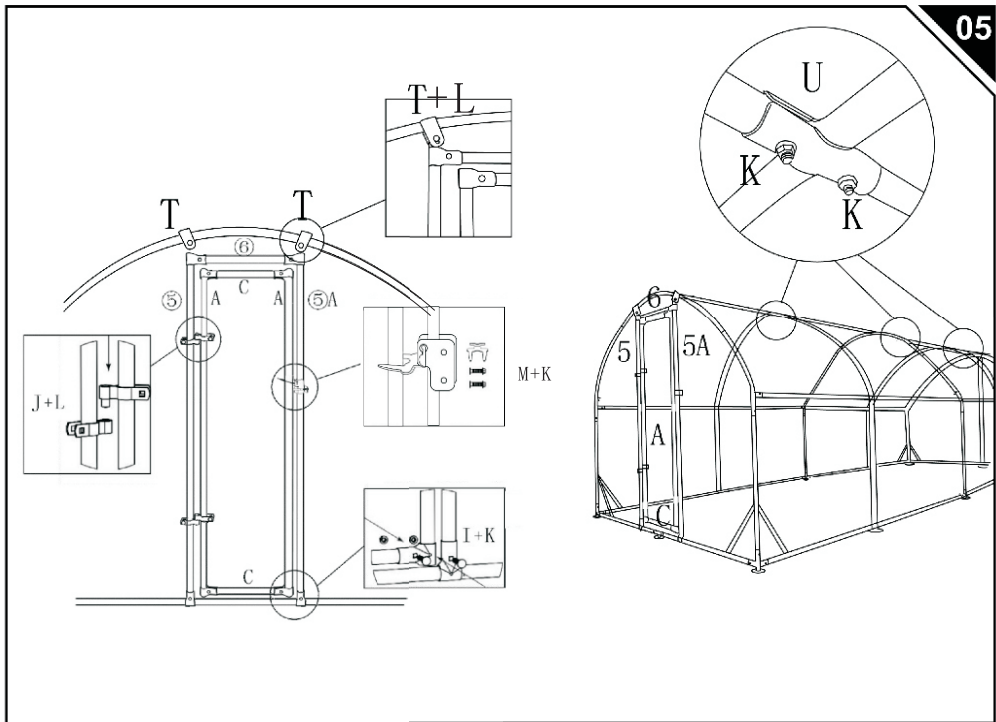

**DIFFERENT HOLES SITUATIONS  
IN E1 & E2**

