

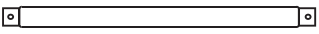









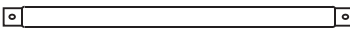
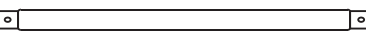
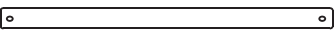
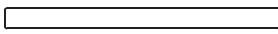
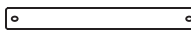
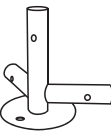
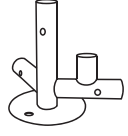
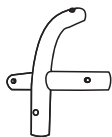
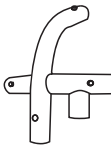
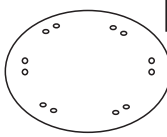

**USER' MANUAL**  

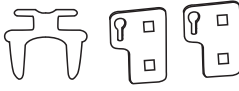
---

**CHICKEN COOP**

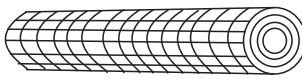

1925MM <b>2</b> x 18 	170MM <b>7</b> x 6 	1600MM <b>4</b> x 6 
1645MM <b>5</b> x 1 	1635MM <b>5A</b> x 1 	1575MM <b>A</b> x 1 
497MM <b>C</b> x 2 	<b>E</b> x 5 	<b>E1</b> x 1 
<b>H</b> x 5 	<b>H1</b> x 1 	<b>J</b> x 1 
<b>K</b> x 1 	M6*15MM <b>L</b> x 12+1 	<b>M</b> x 6 
<b>N</b> x 1 	<b>O</b> x 12 	M6*40MM <b>P</b> x 8+1 
<b>Q</b> x 18 	<b>R</b> x 1 	<b>S</b> x 1 
<b>U</b> 		

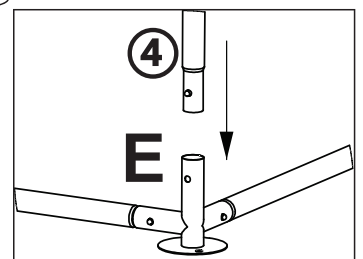
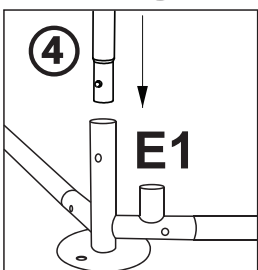
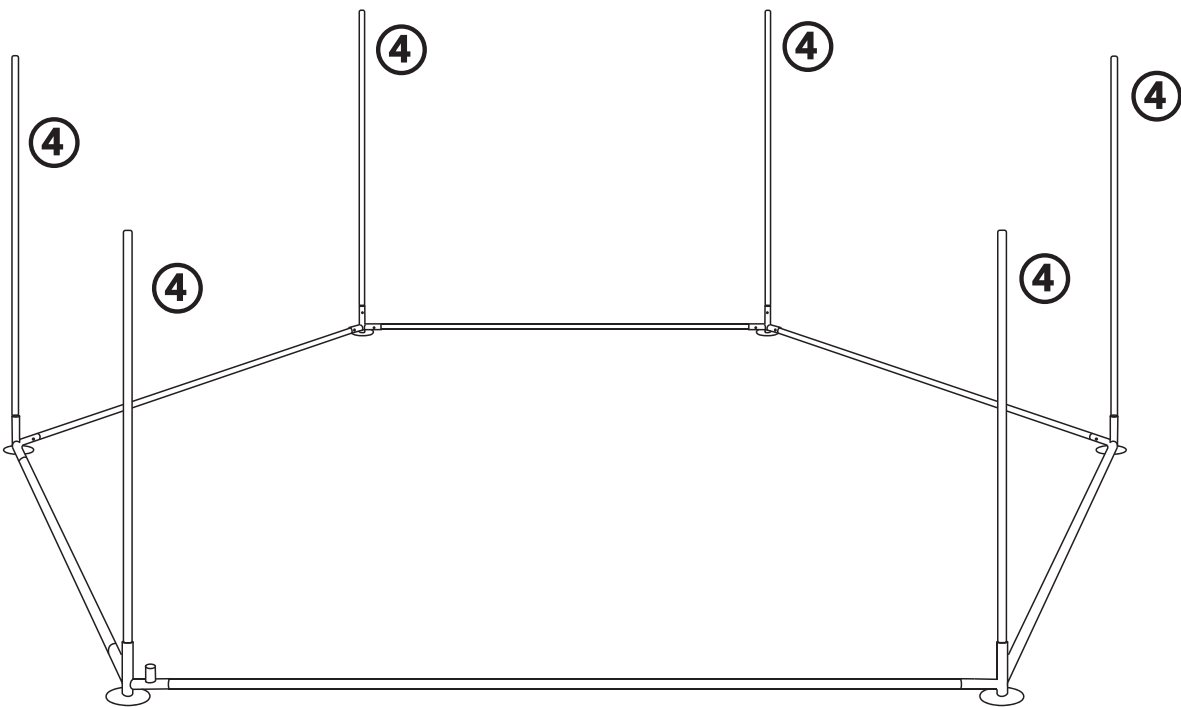
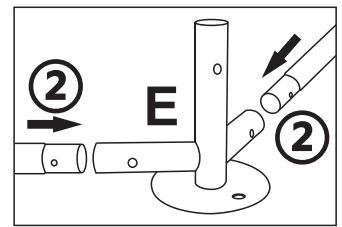
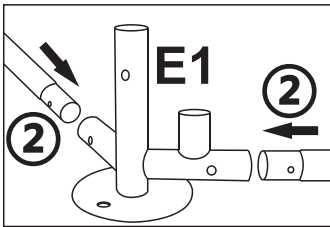
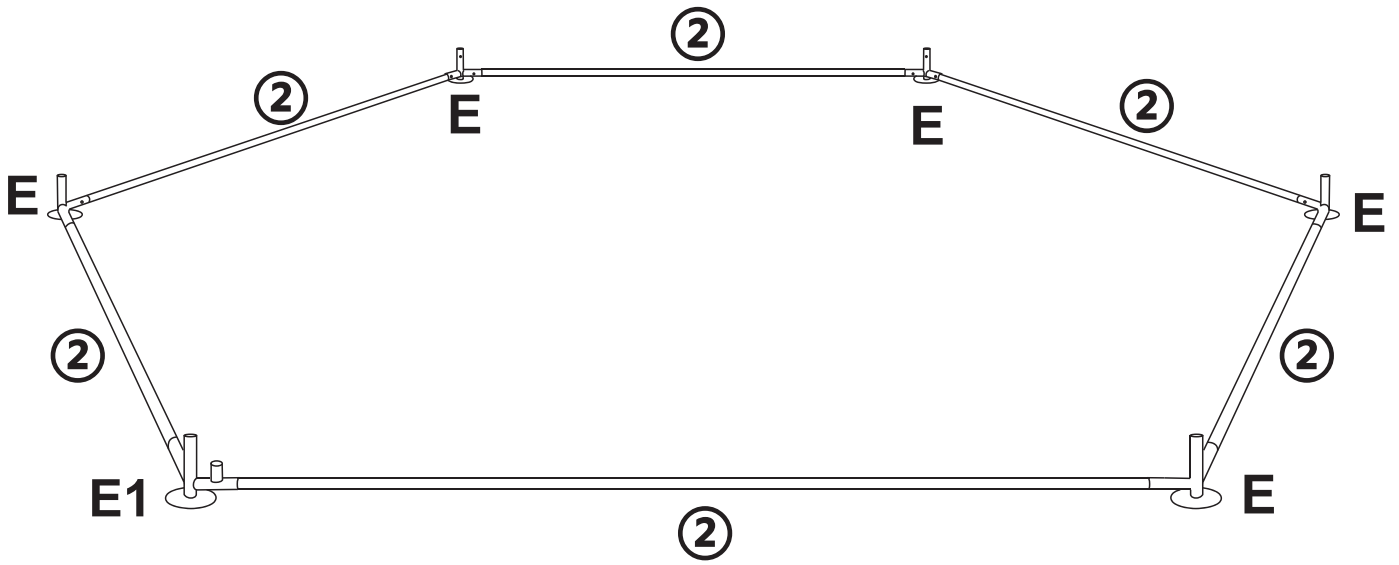

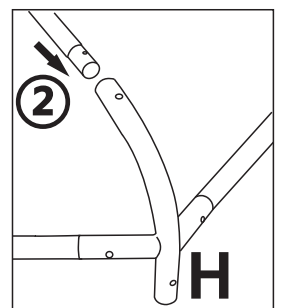
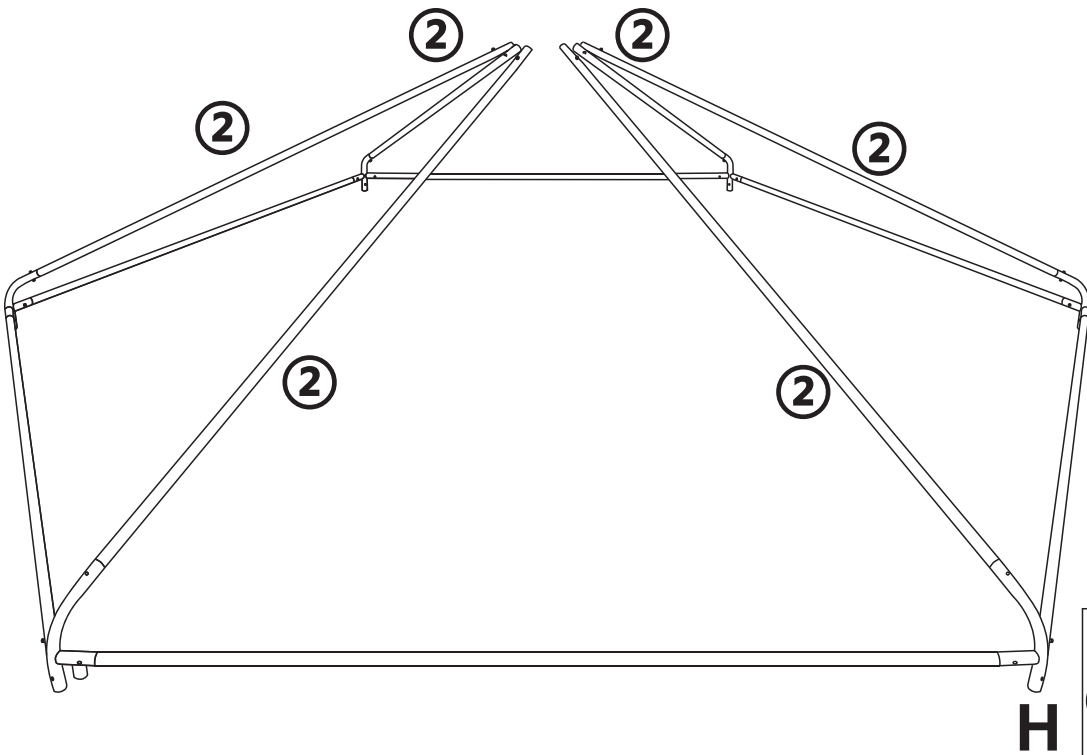
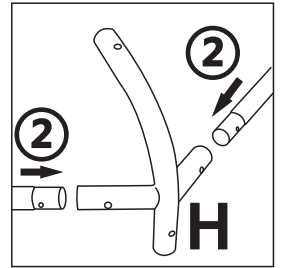
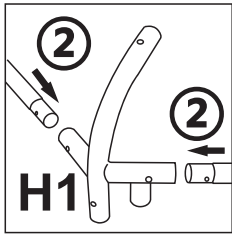
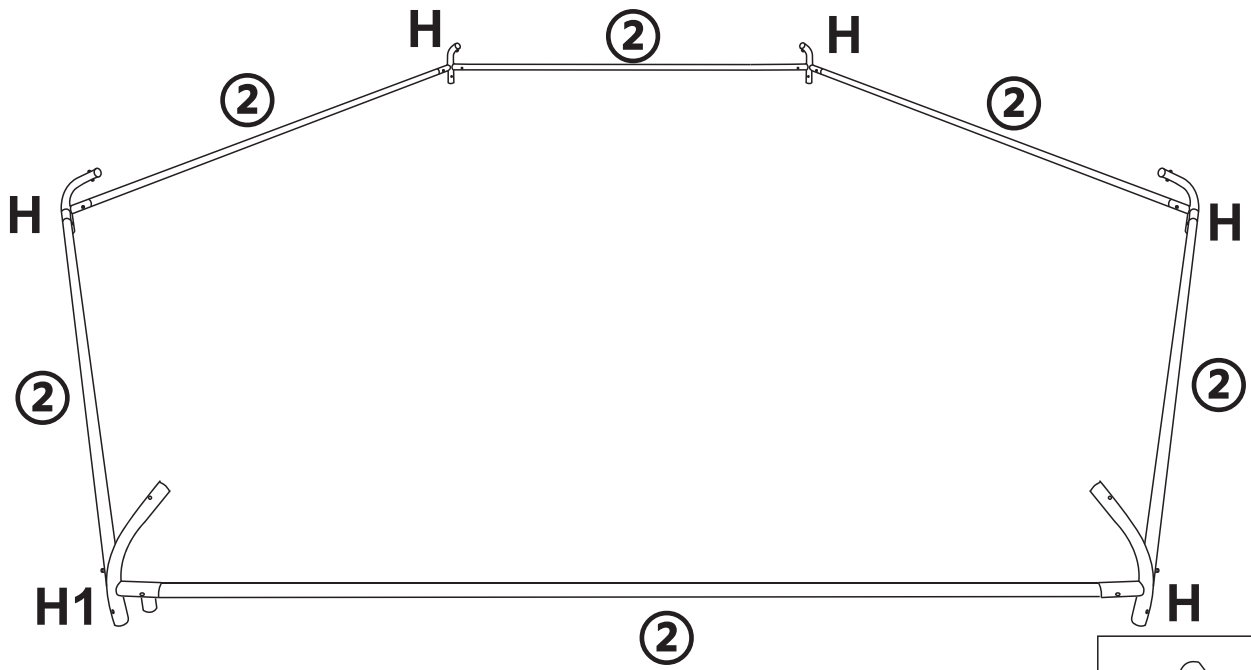

⑦ x6

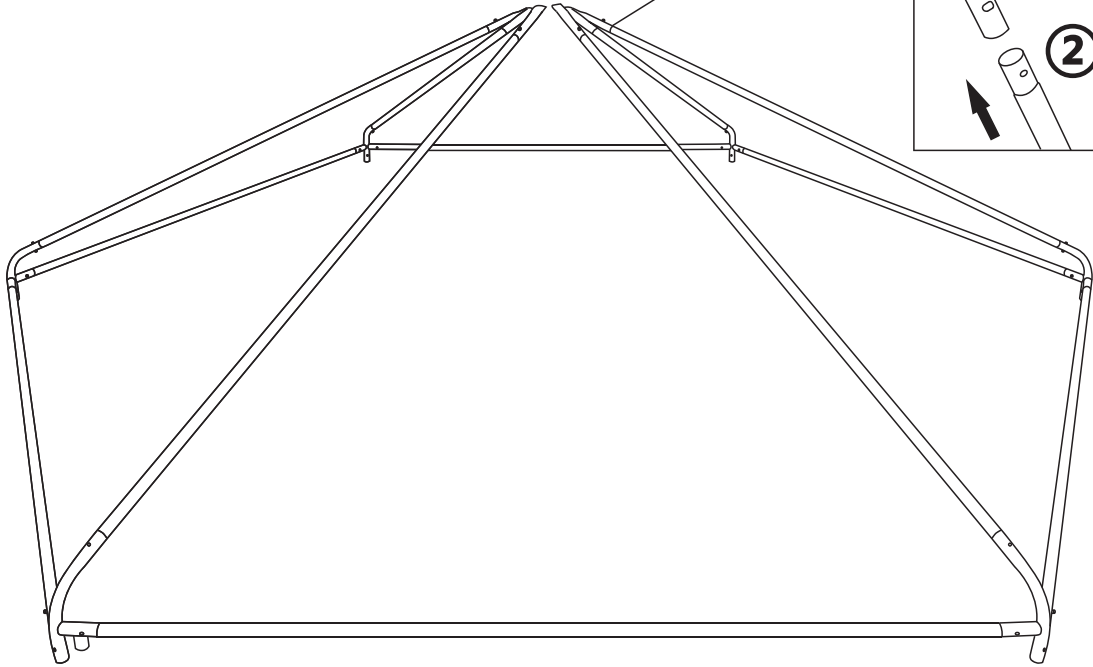
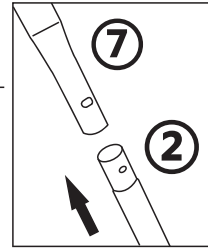

L M6\*15 X12

J

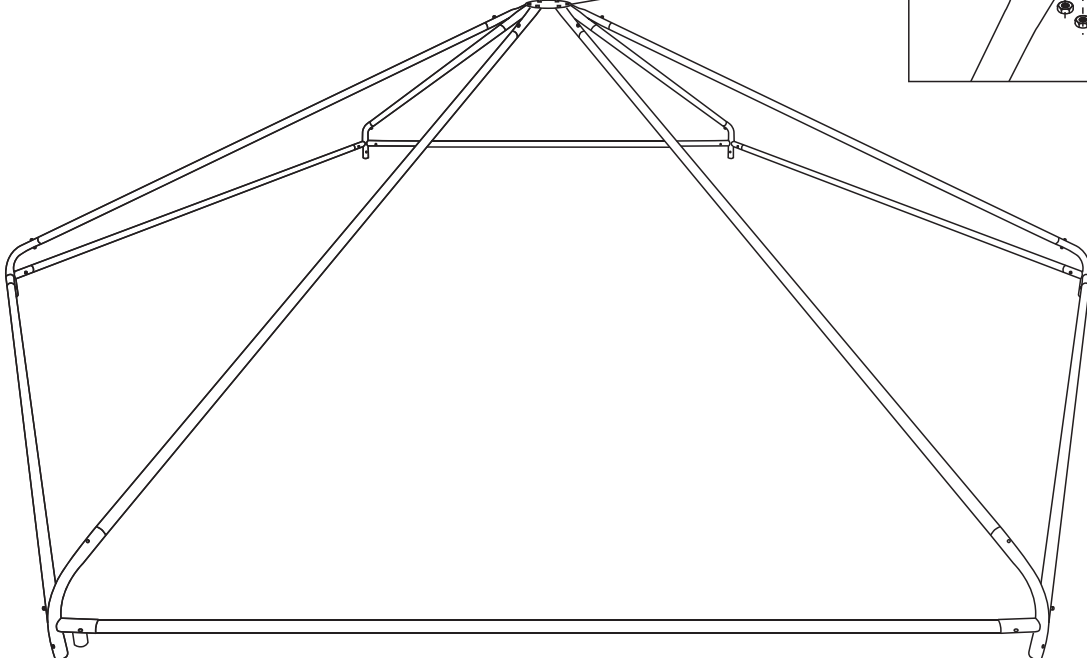
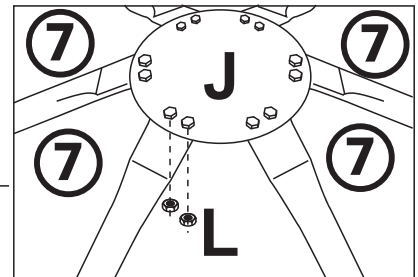

M60\*40MM x 4pcs

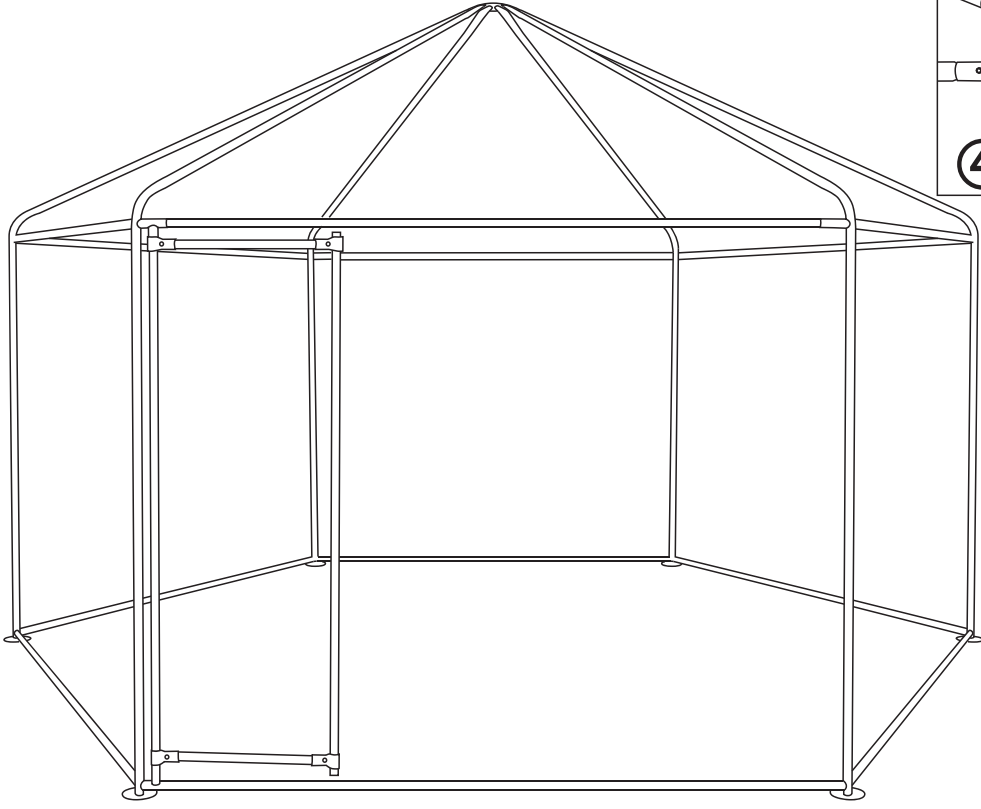
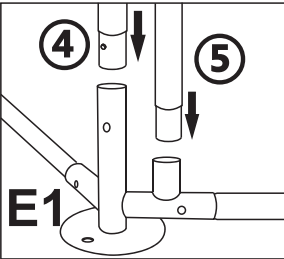
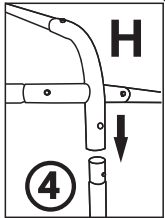
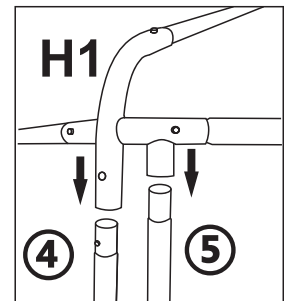
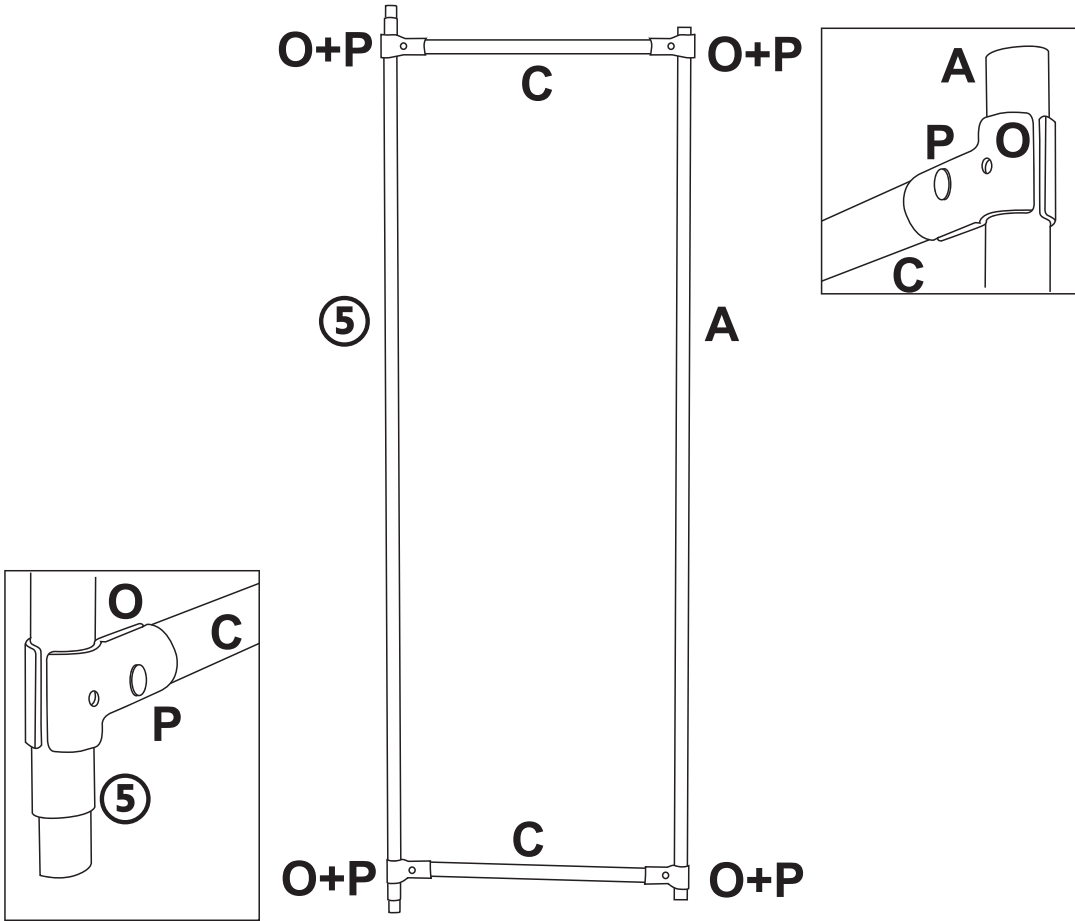

M60\*40MM x 4pcs

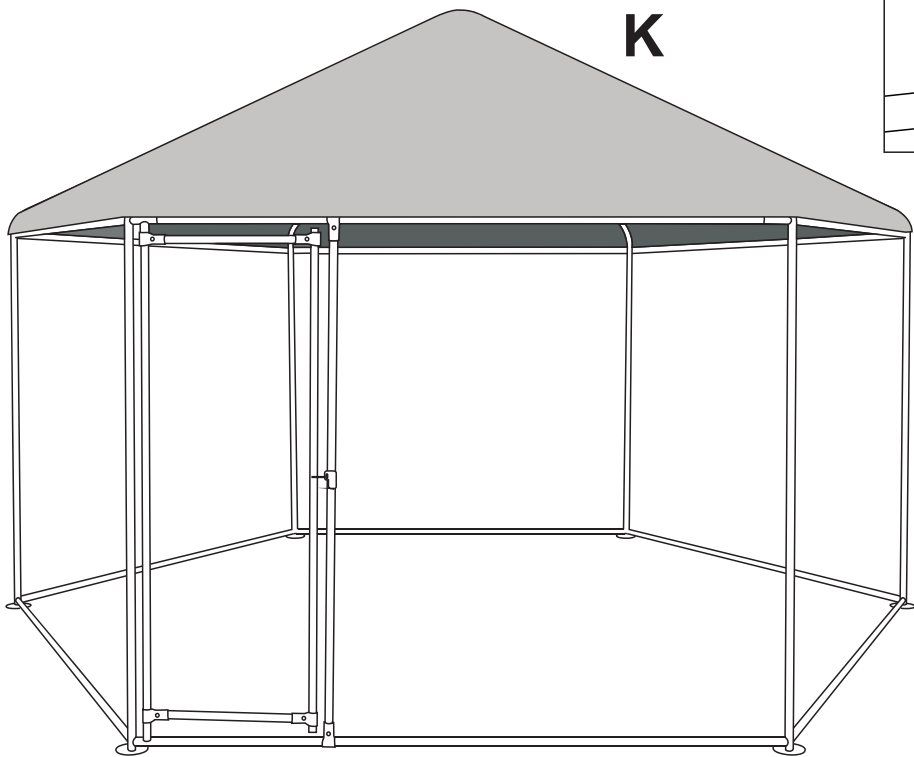
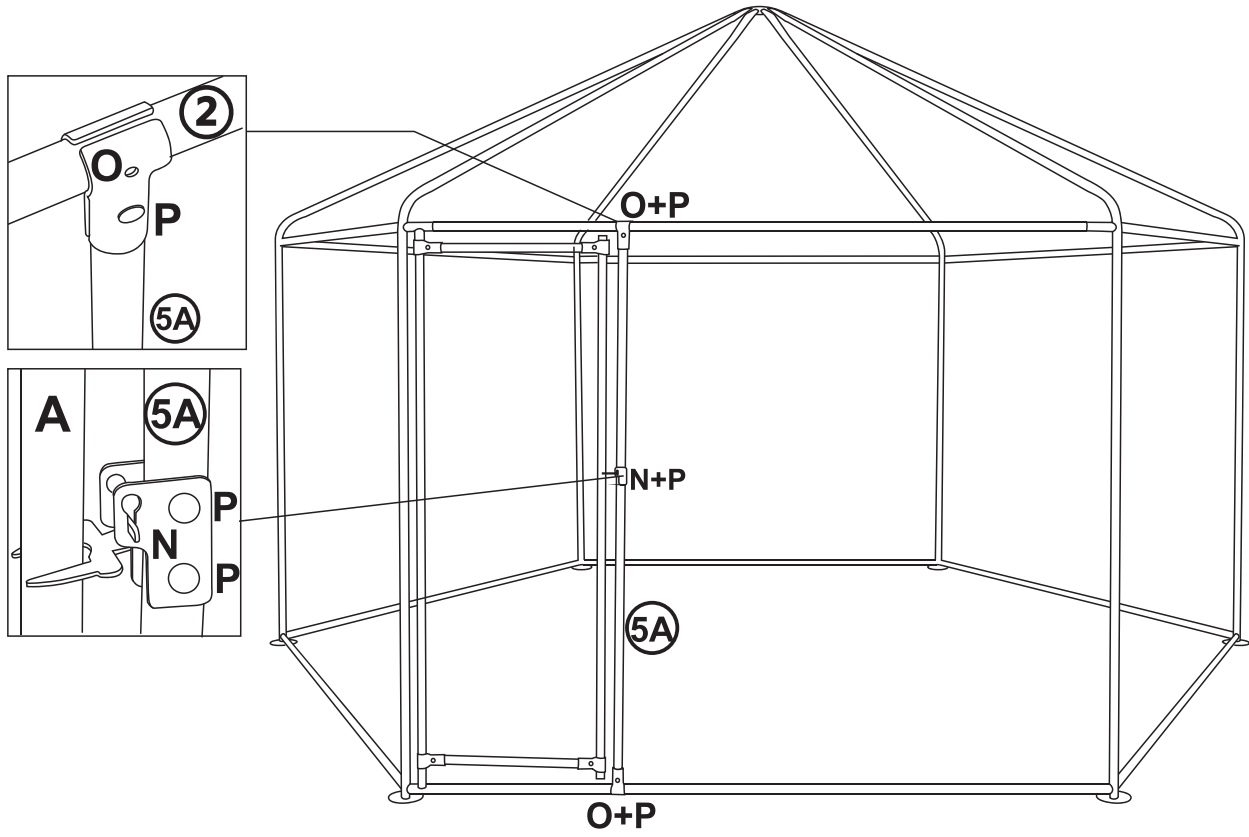

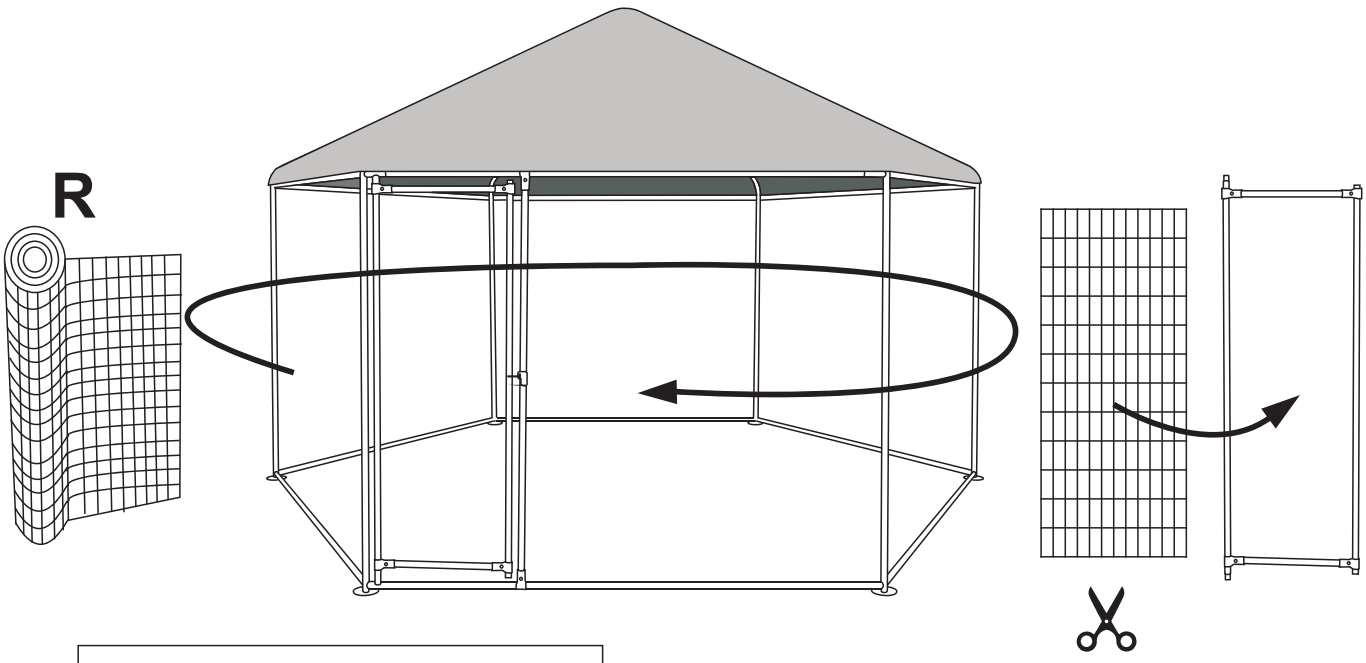

U

