

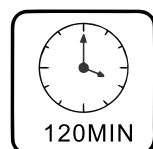

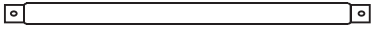

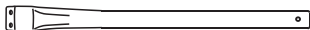

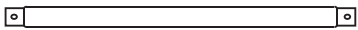



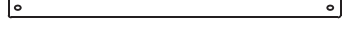
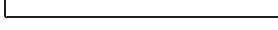
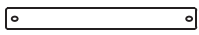
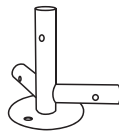
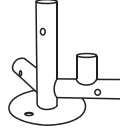
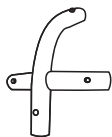
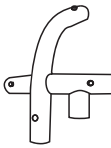
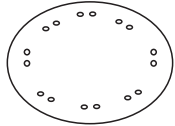

# USER' MANUAL

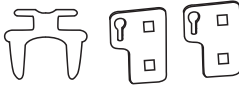
---

## CHICKEN COOP

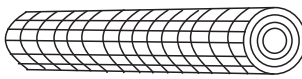

1925MM  <b>2</b> x 24	780MM  <b>7</b> x 8	1600MM  <b>4</b> x 8
1645MM  <b>5</b> x 1	1635MM  <b>5A</b> x 1	1575MM  <b>A</b> x 1
497MM  <b>C</b> x 2	 <b>E</b> x 7	 <b>E1</b> x 1
 <b>H</b> x 7	 <b>H1</b> x 1	 <b>J</b> x 1
 <b>K</b> x 1	M6*15MM  <b>L</b> x 16+1	  <b>M</b> x 6
 <b>N</b> x 1	 <b>O</b> x 12	M6*40MM  <b>P</b> x 8+1
 <b>Q</b> x 24	 <b>R</b> x 1	 <b>S</b> x 1
 <b>U</b>		

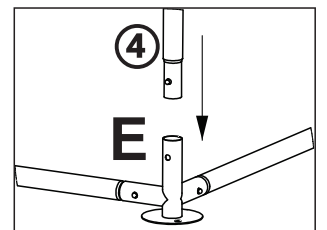
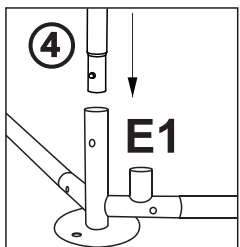
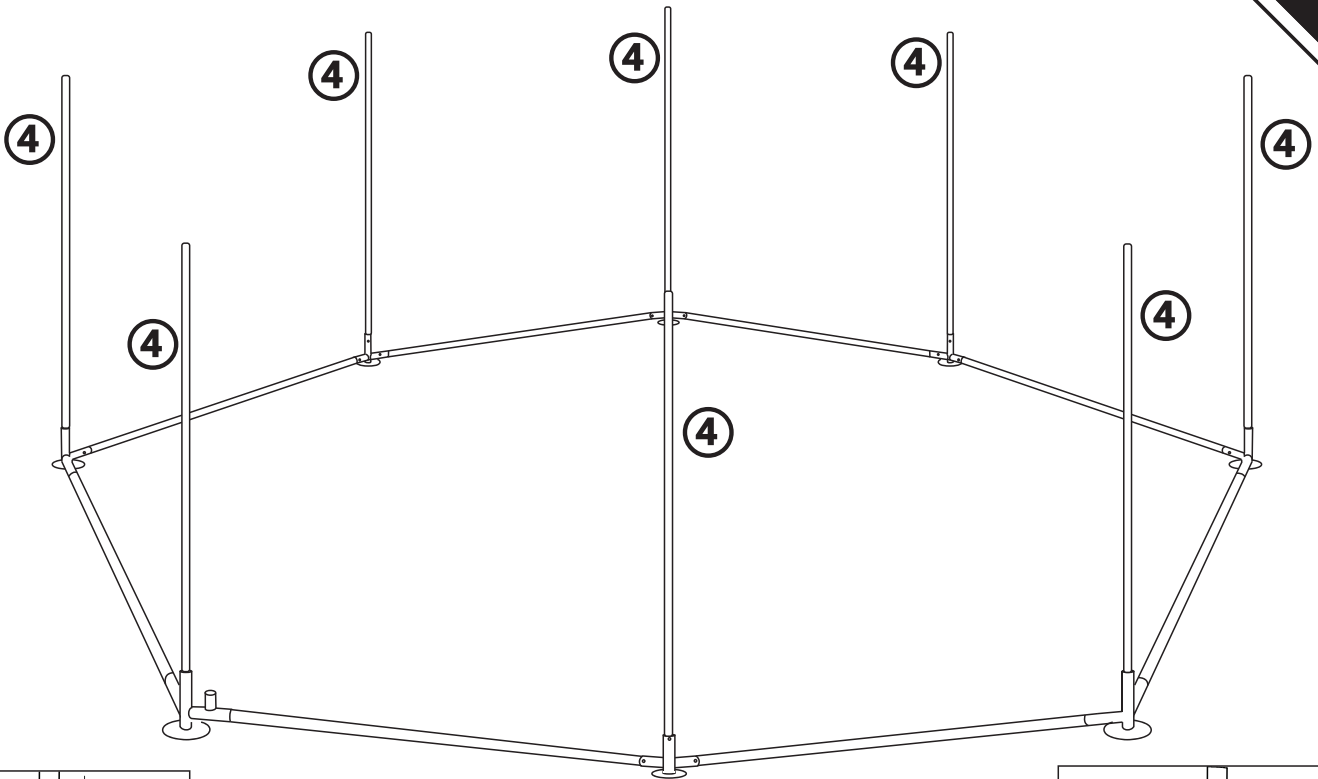
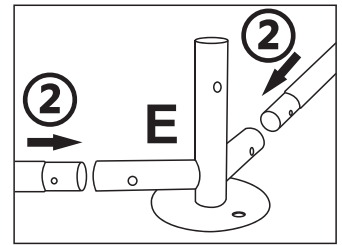
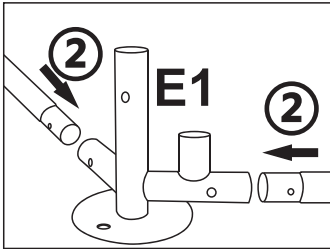
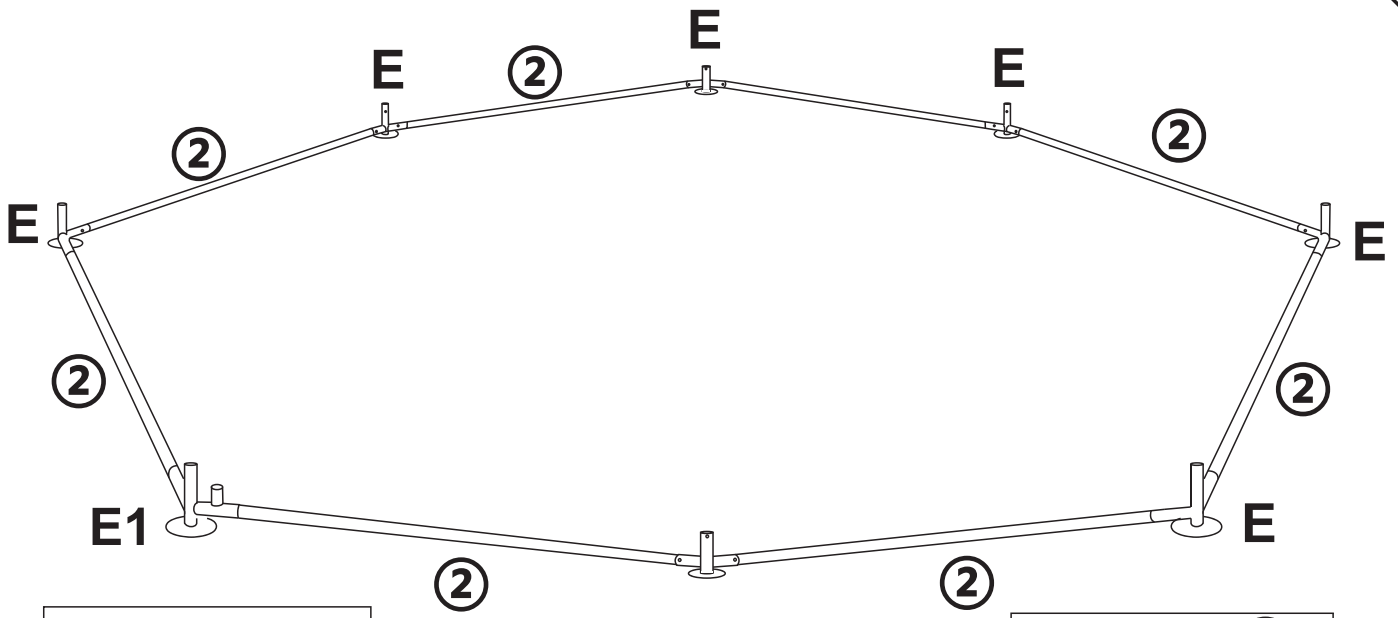

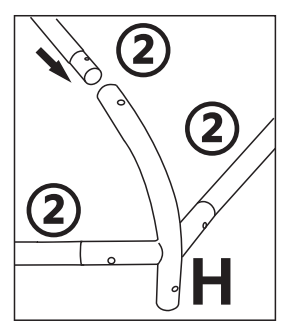
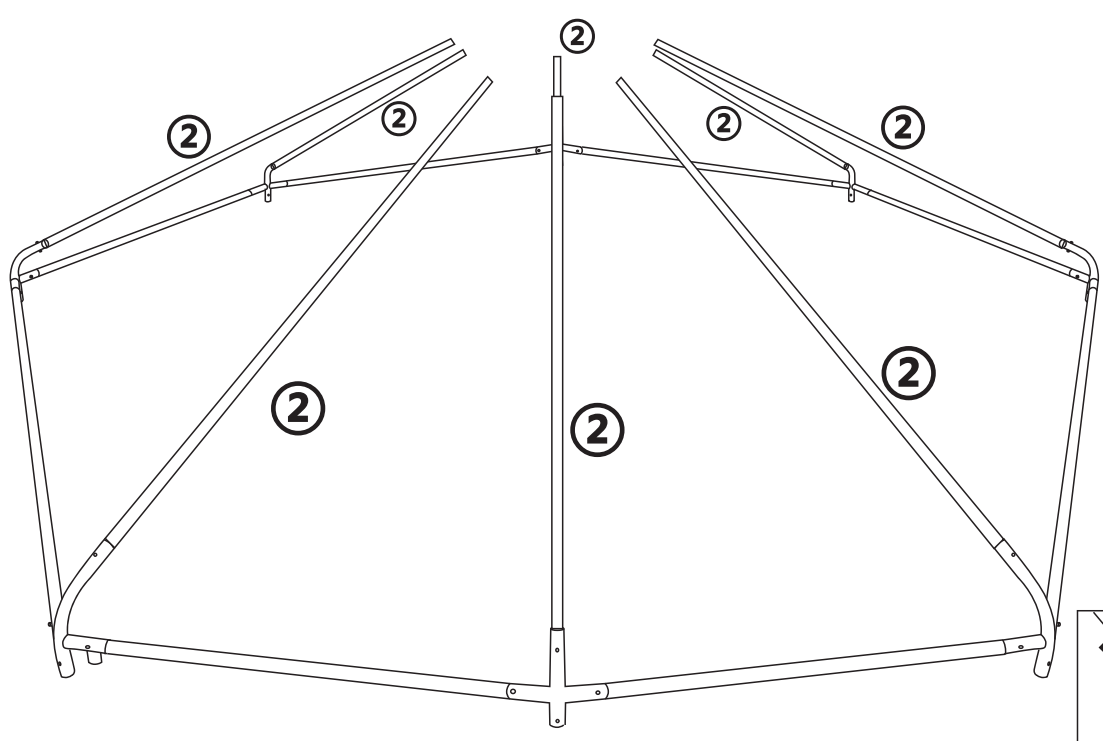
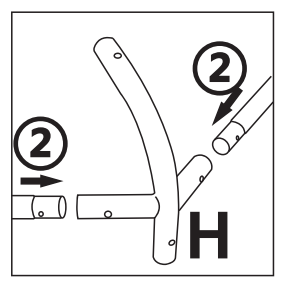
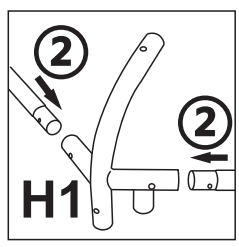
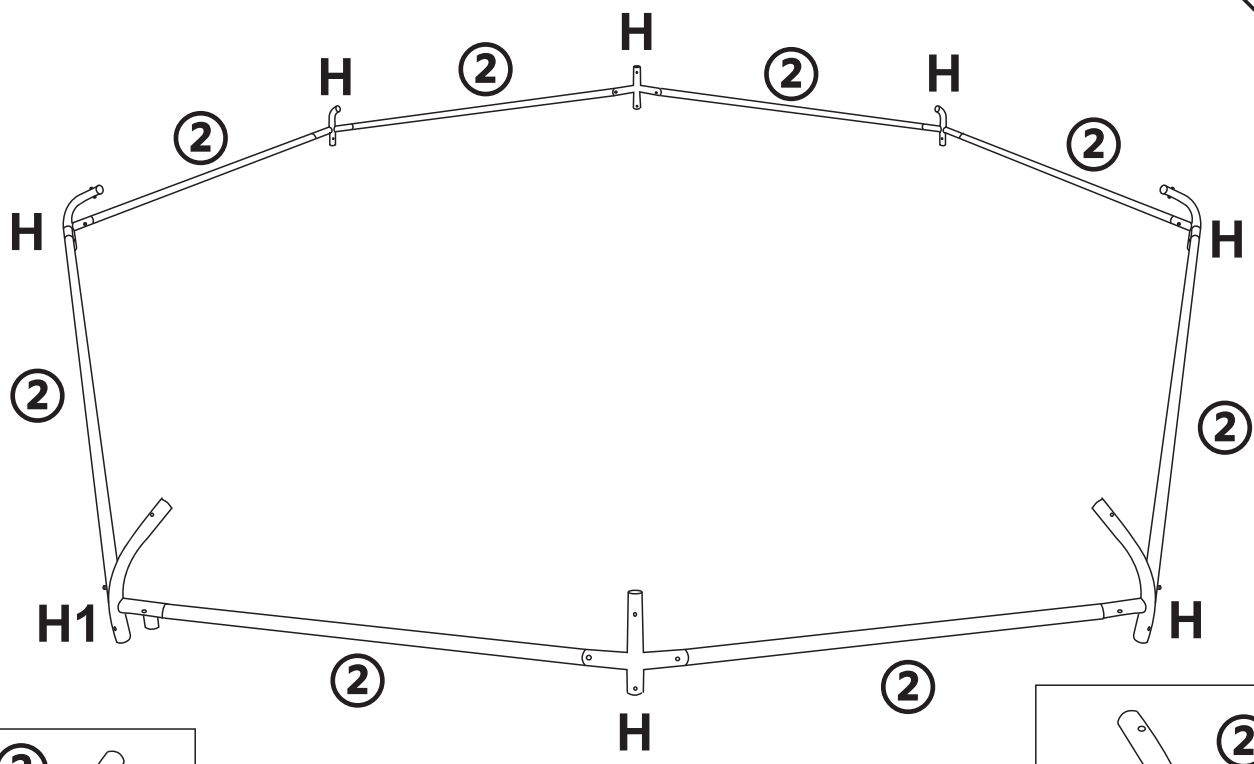

⑦x8

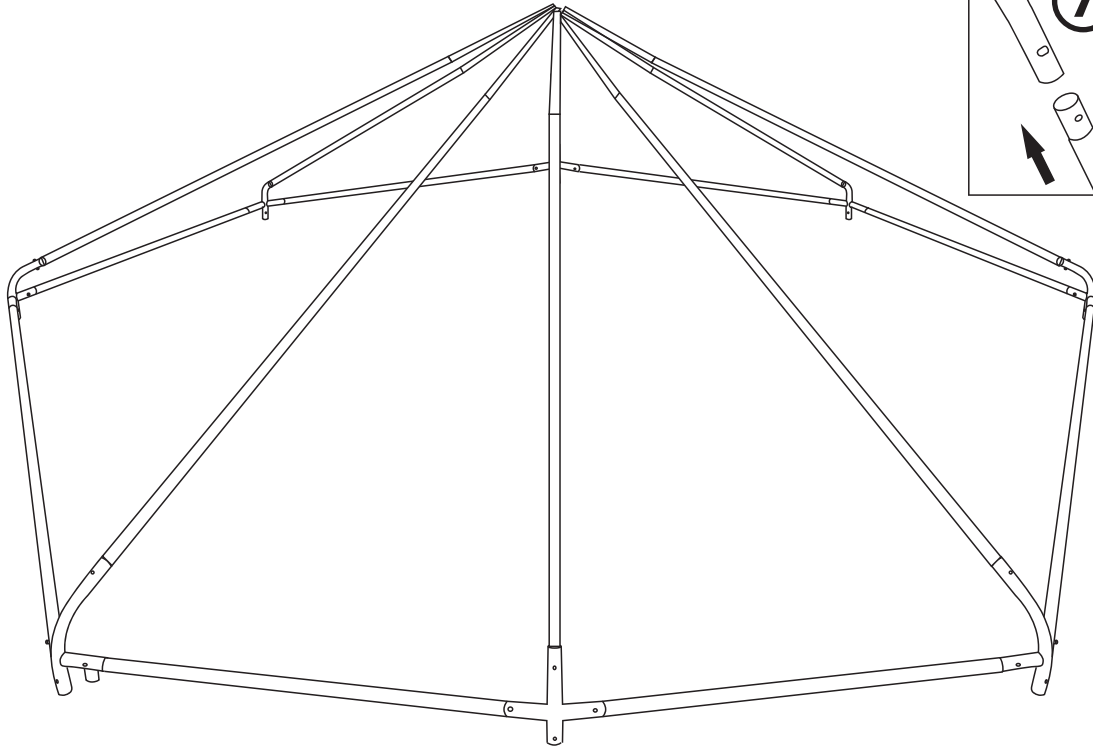
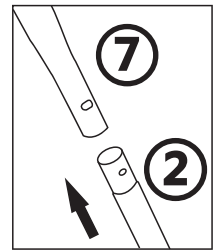

M6\*15MM X16PCS

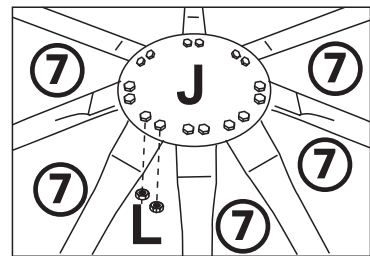

J

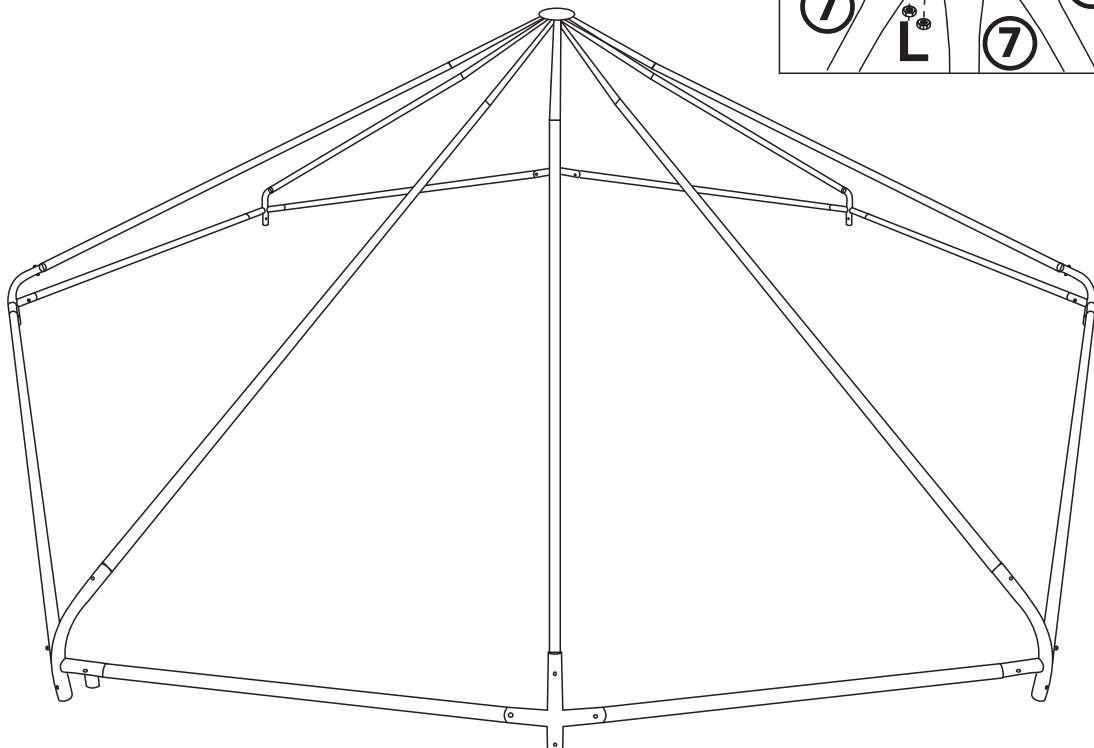

M60\*40MM x 4pcs

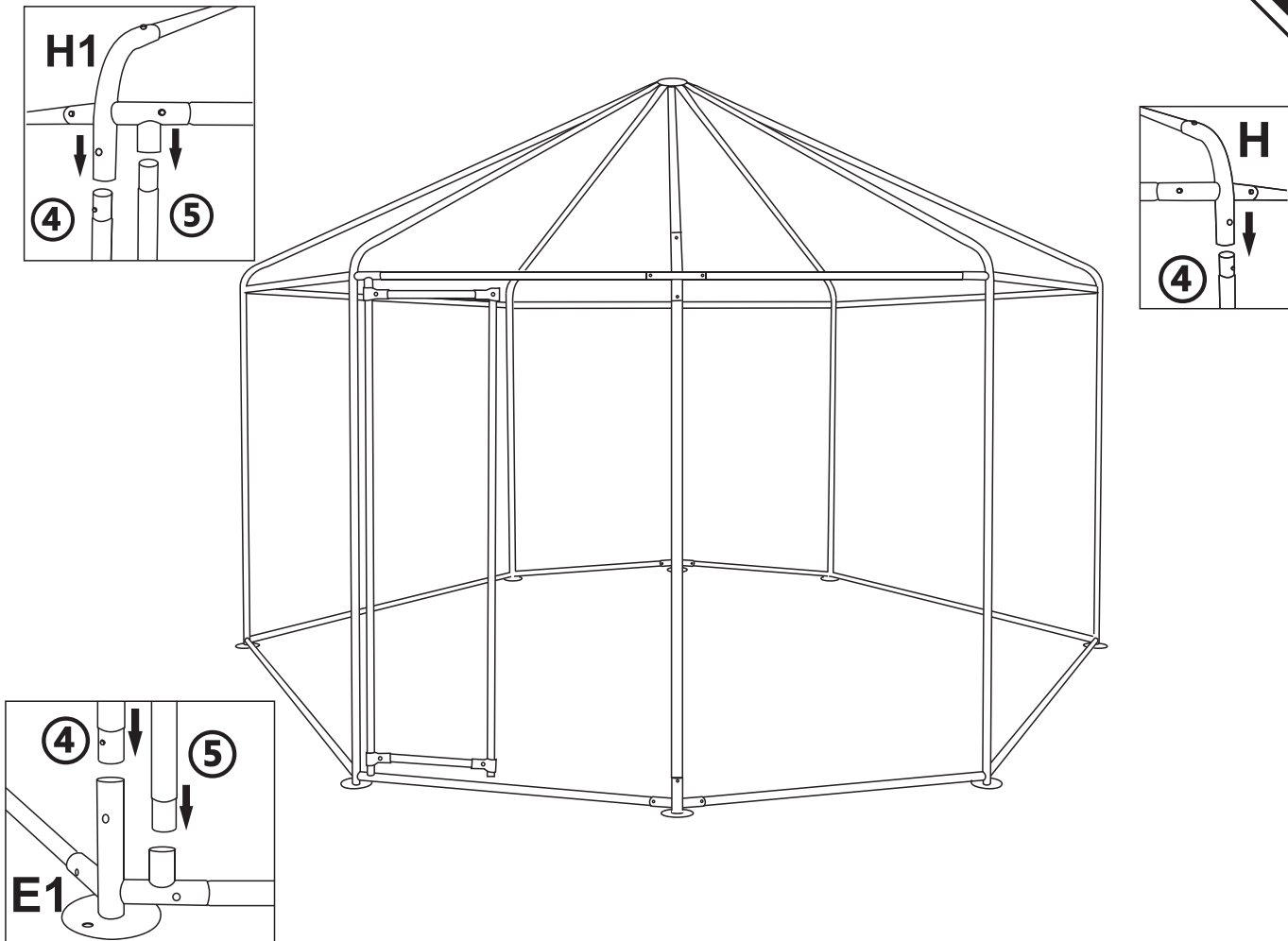
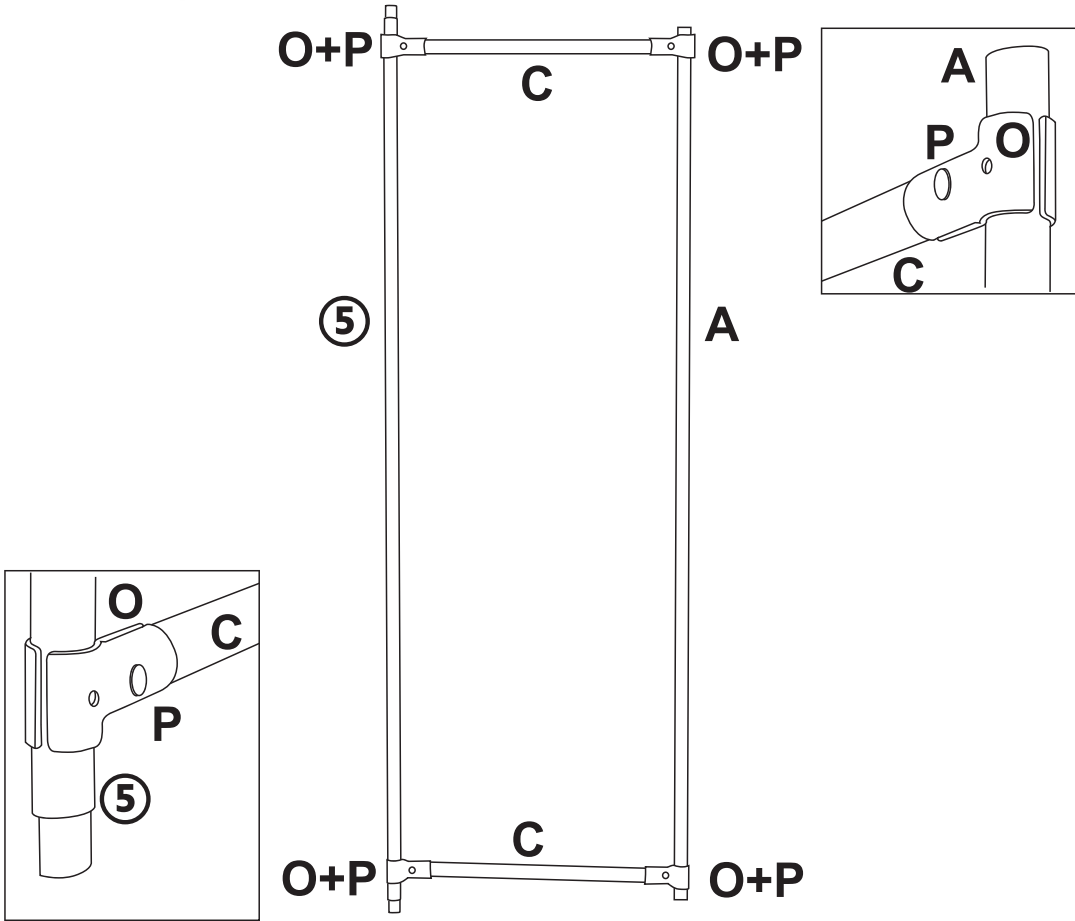

M60\*40MM x 4pcs

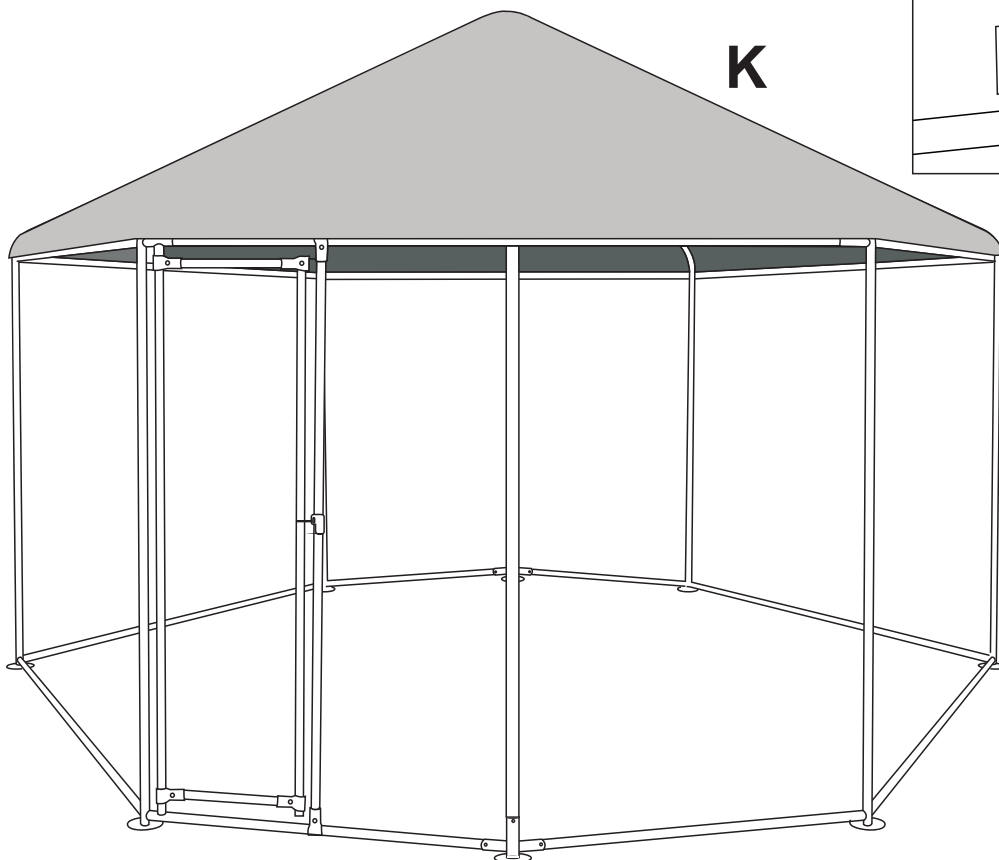
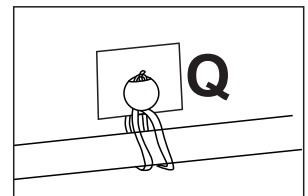
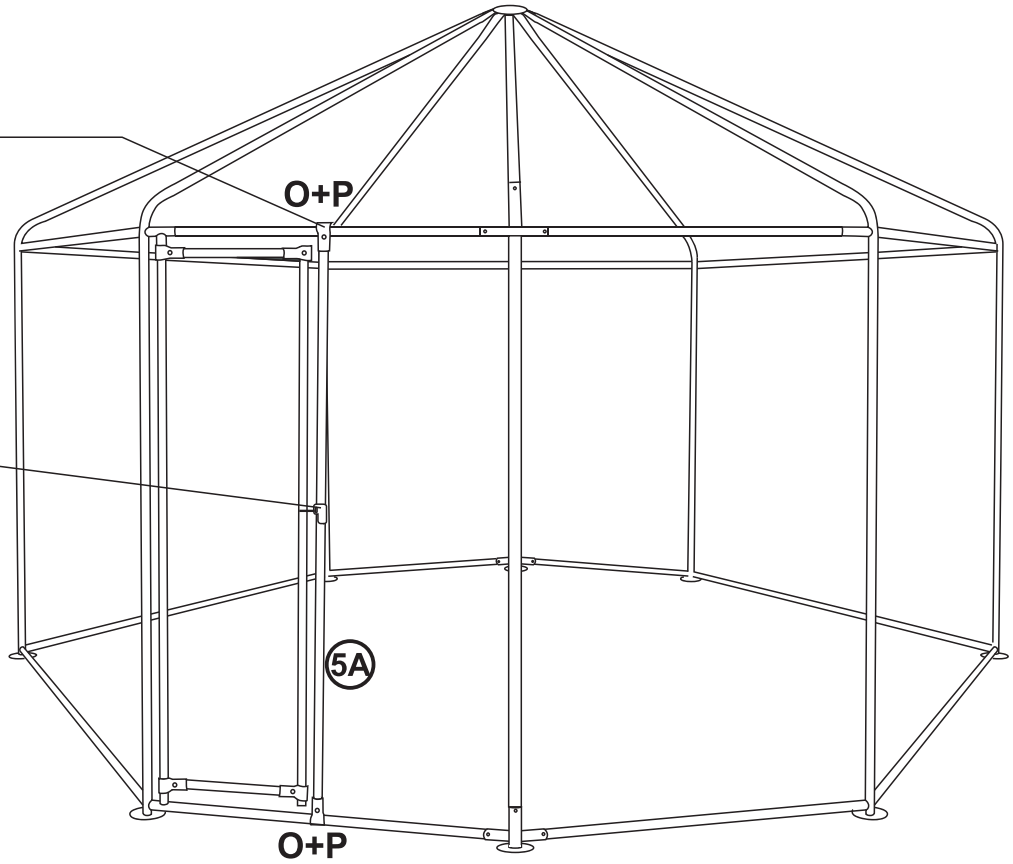
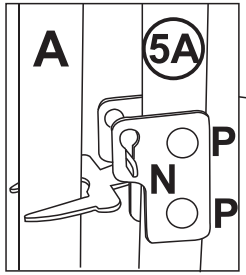
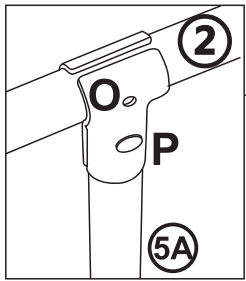

R

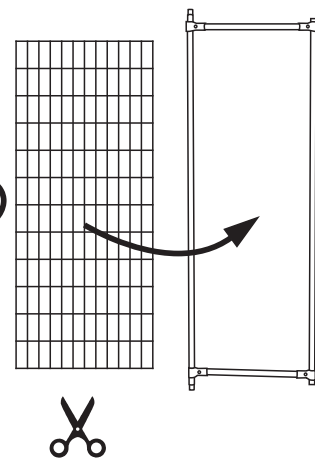
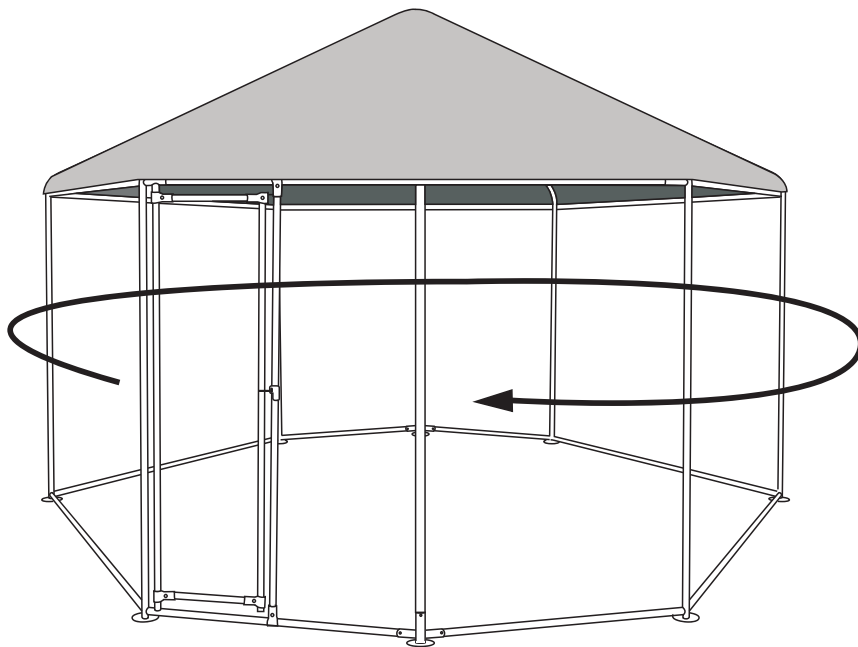
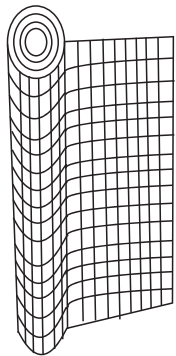

U

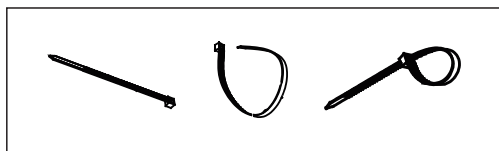

M

M

M

M

