

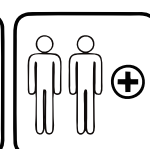

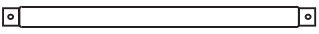







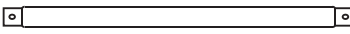
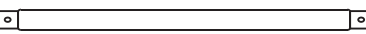
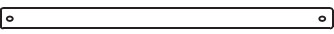
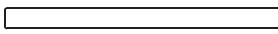
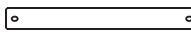
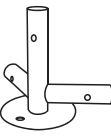
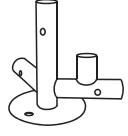
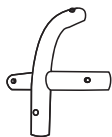
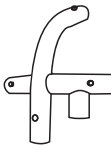
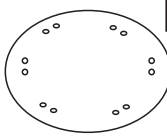

**USER' MANUAL**  

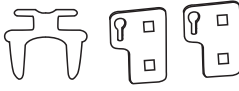
---

**CHICKEN COOP**

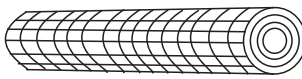

1320MM 	<b>1</b> x 18	170MM 	<b>7</b> x 6	1600MM 	<b>4</b> x 6
1645MM 	<b>5</b> x 1	1635MM 	<b>5A</b> x 1	1575MM 	<b>A</b> x 1
497MM 	<b>C</b> x 2		<b>E</b> x 5		<b>E1</b> x 1
	<b>H</b> x 5		<b>H1</b> x 1		<b>J</b> x 1
	<b>K</b> x 1	M6*15MM 	<b>L</b> x 12+1	 	<b>M</b> x 6
	<b>N</b> x 1		<b>O</b> x 12	M6*40MM 	<b>P</b> x 8+1
	<b>Q</b> x 12		<b>R</b> x 1		<b>S</b> x 1
	<b>U</b>				

01

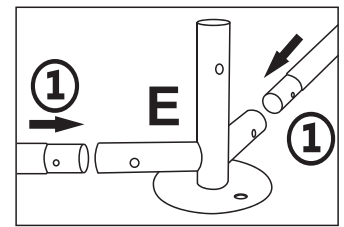
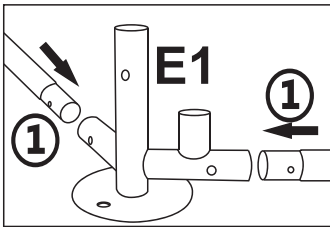
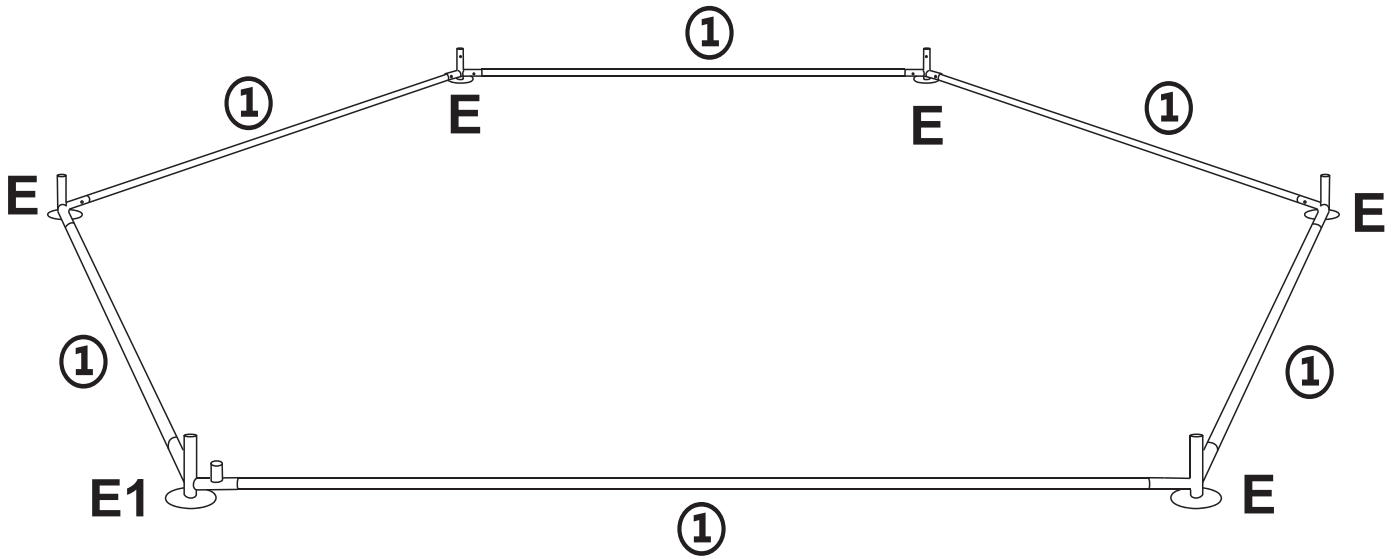

02

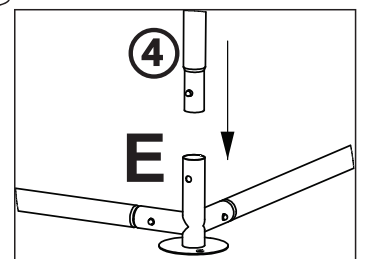
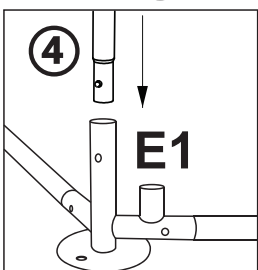
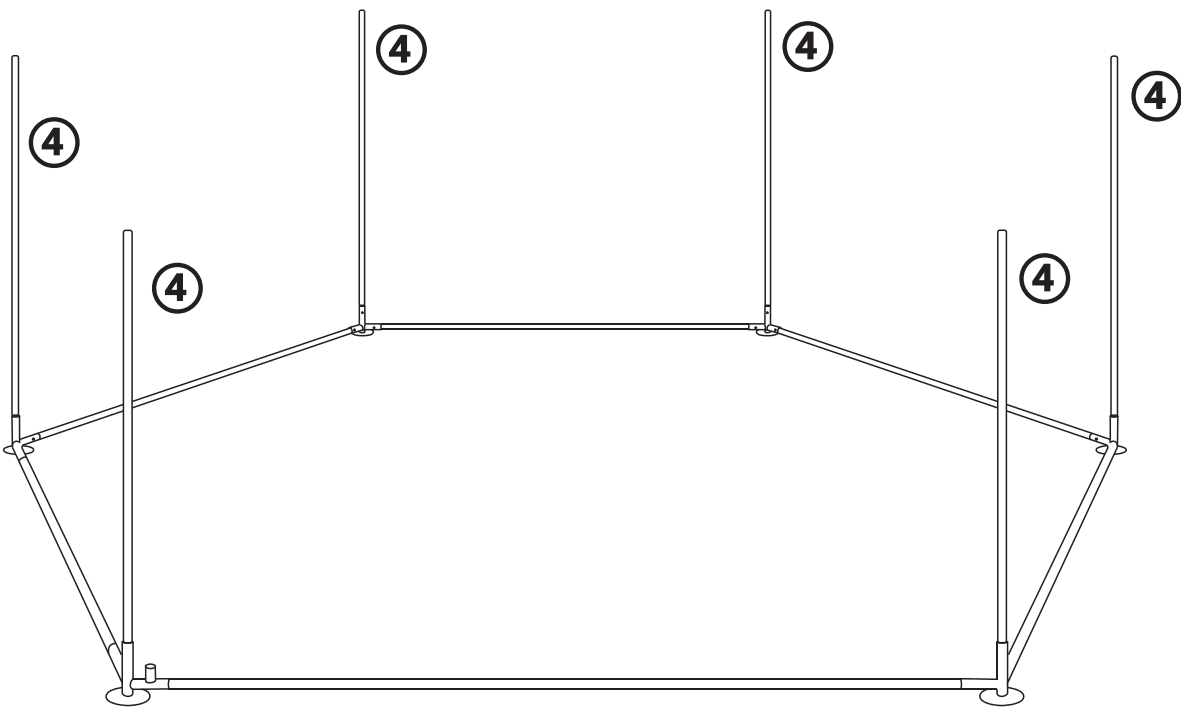

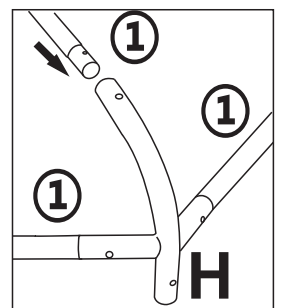
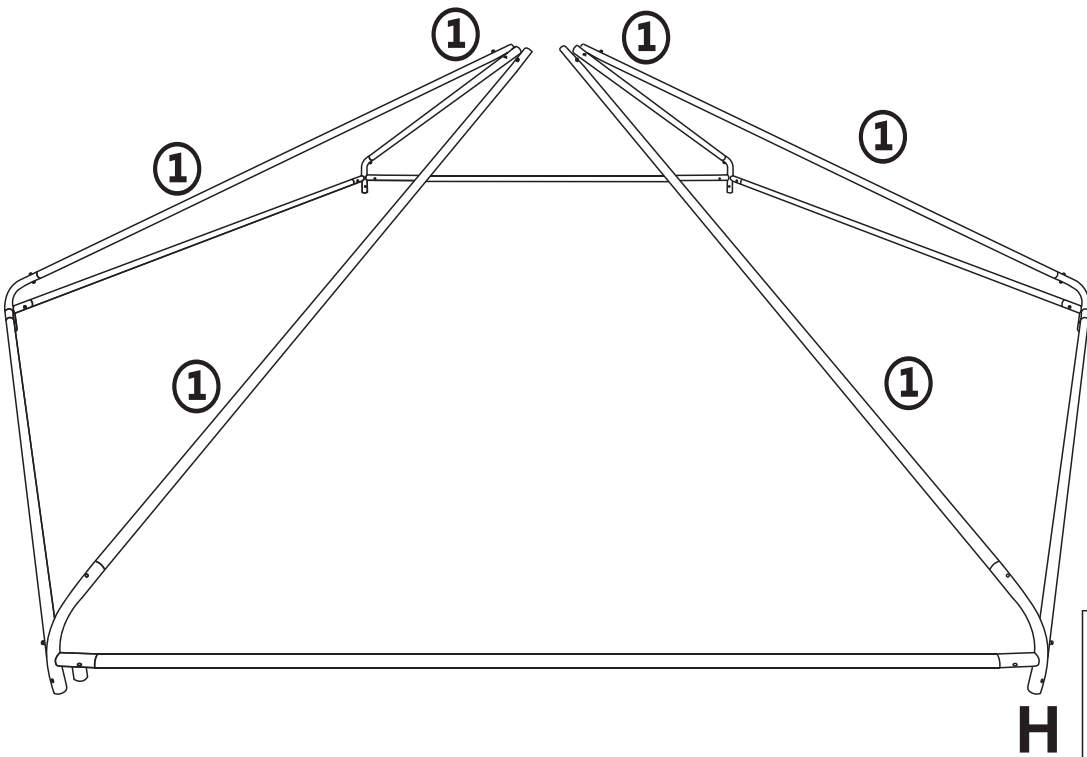
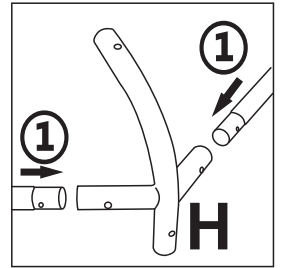
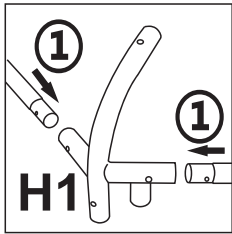
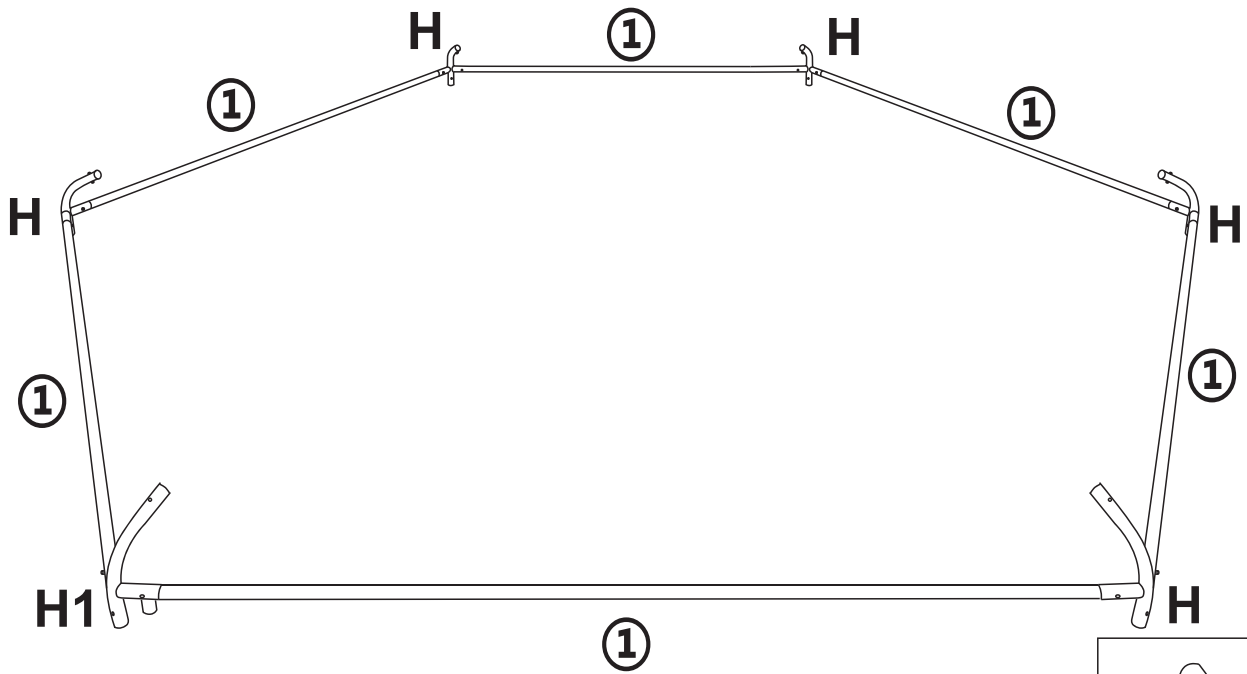

⑦ x6

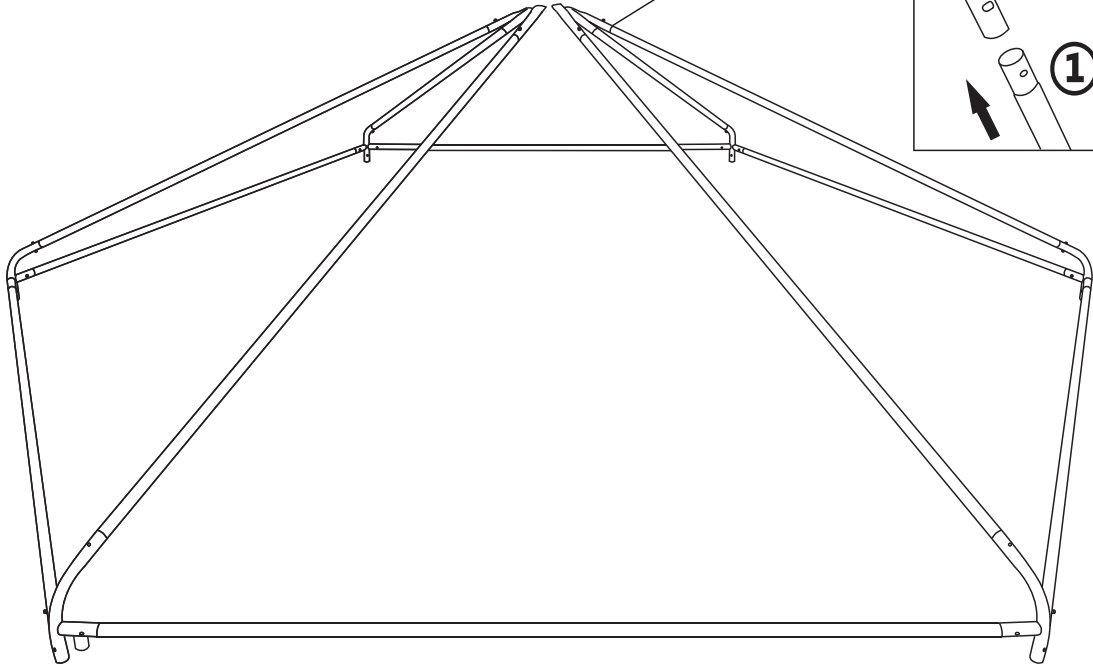
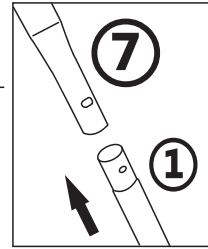

L M6\*15 X12

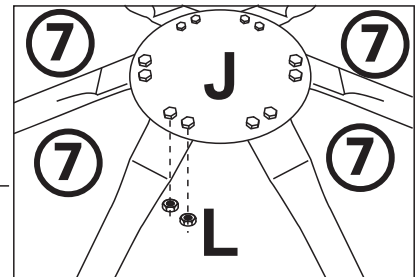

J

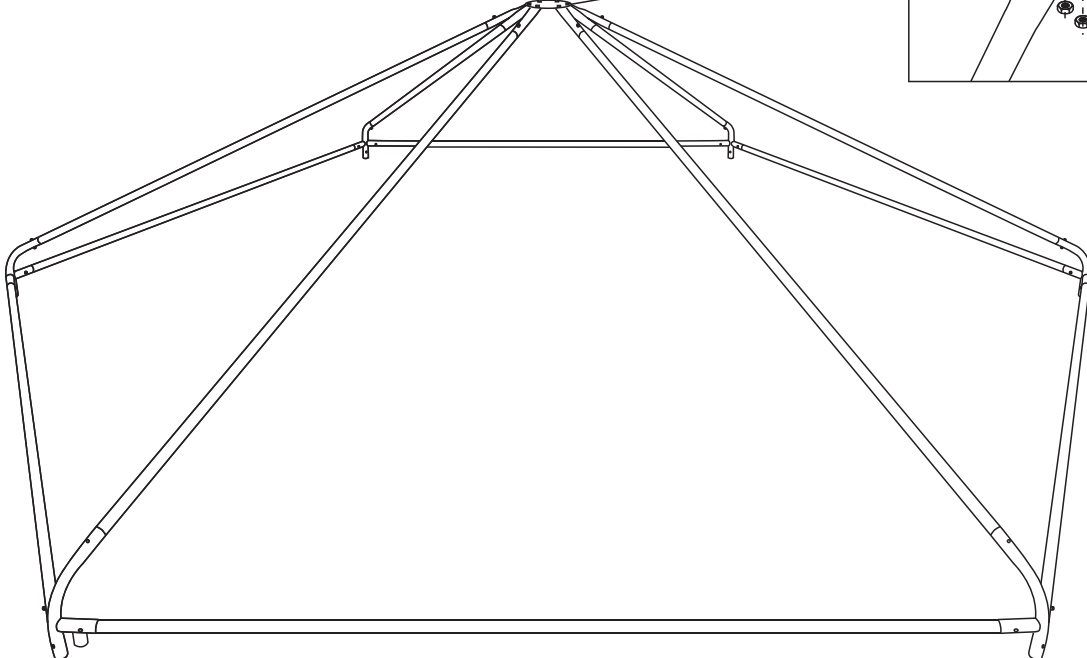

M60\*40MM x 4pcs

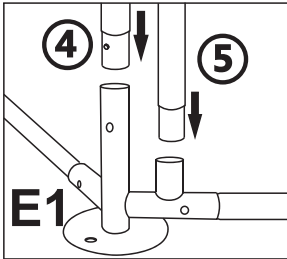
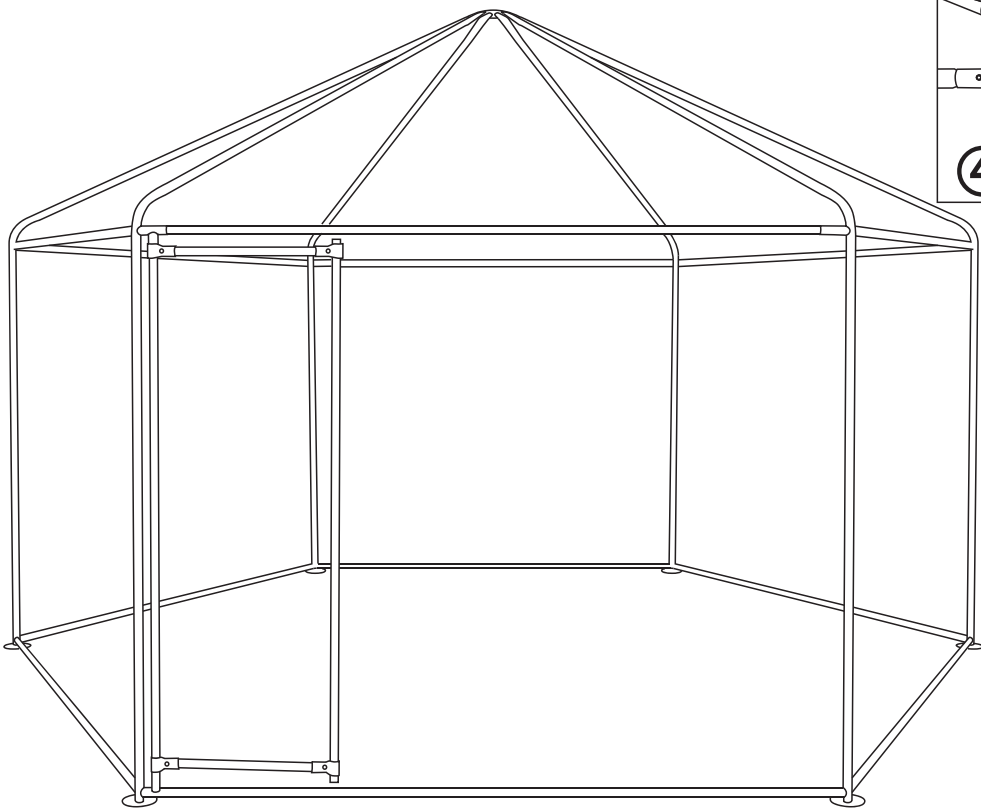
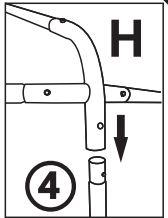
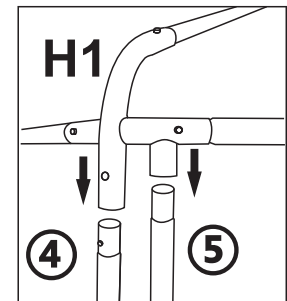
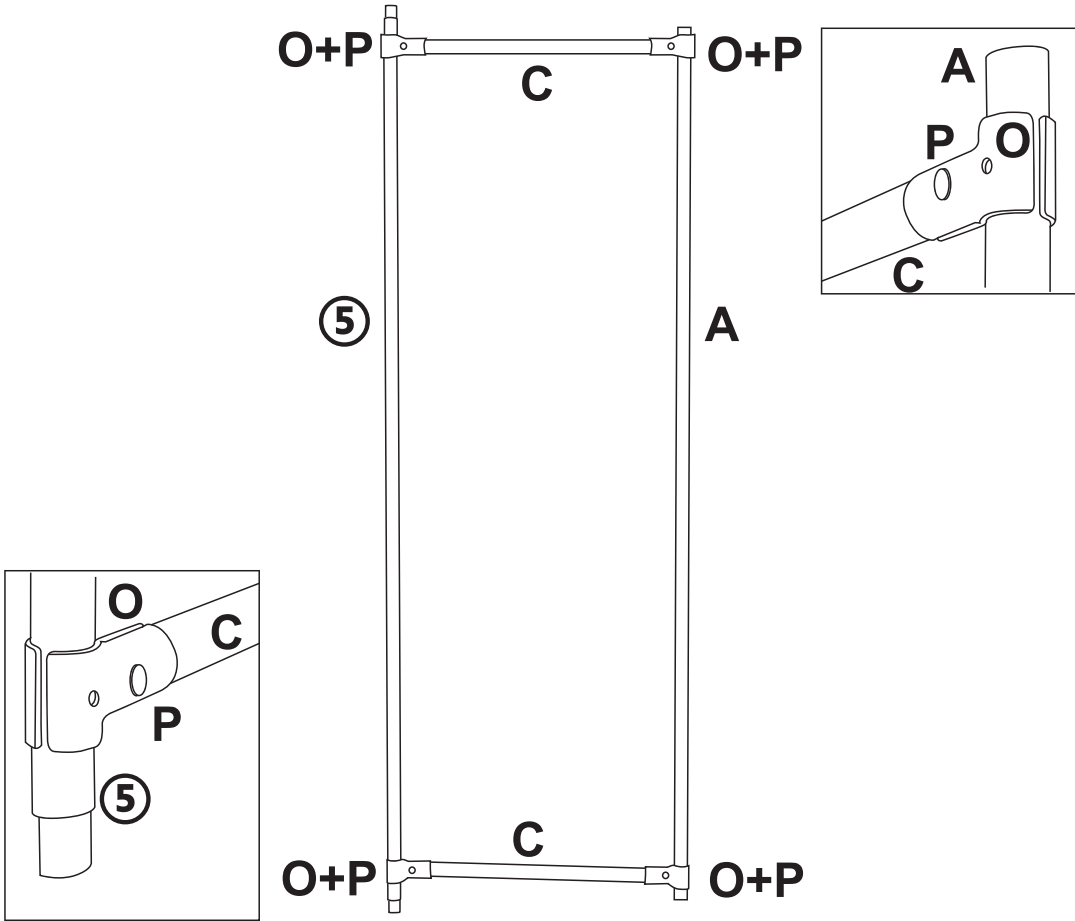

M60\*40MM x 4pcs

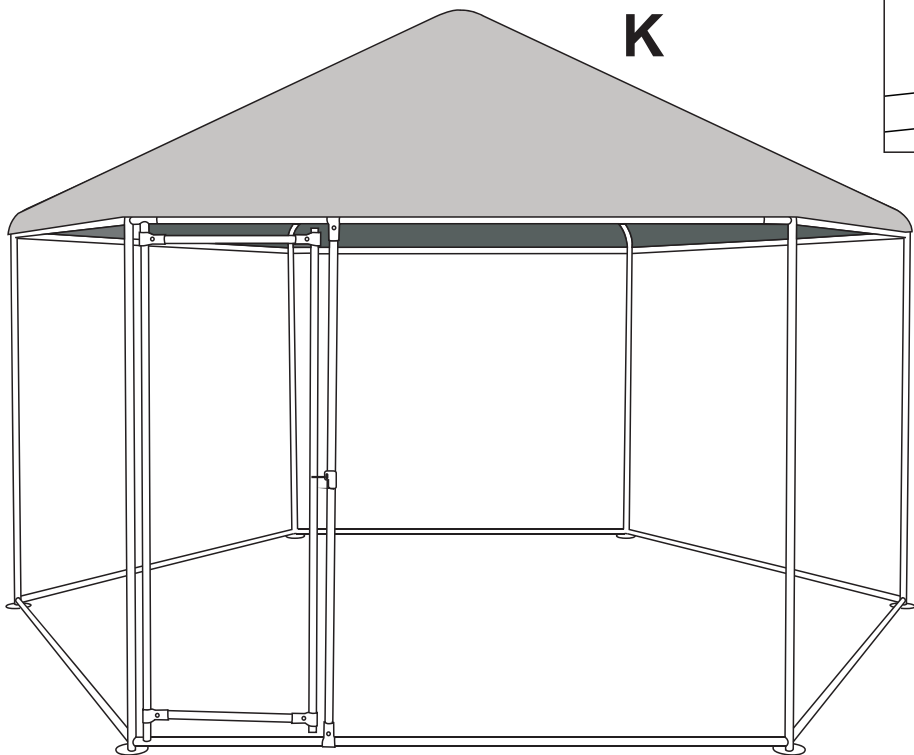
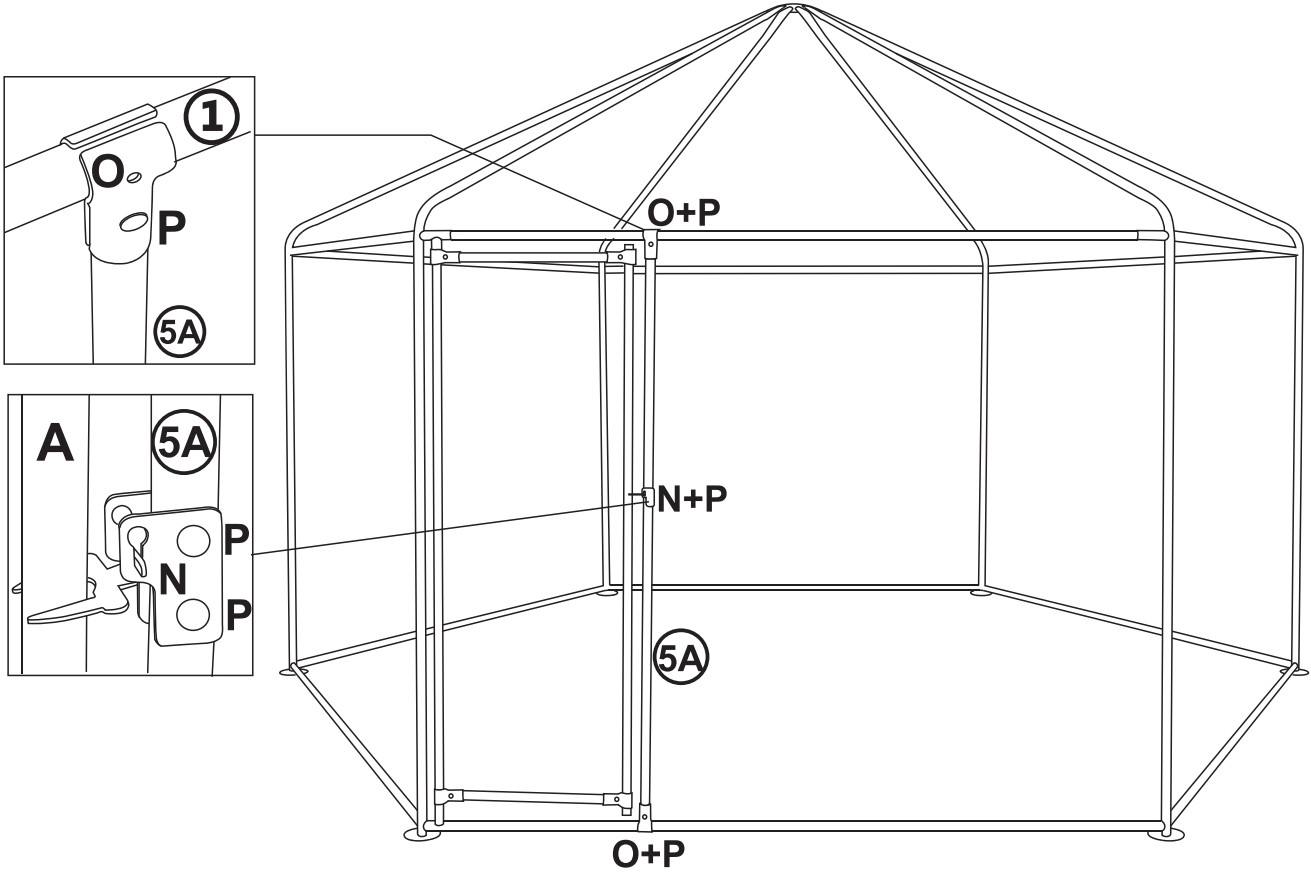

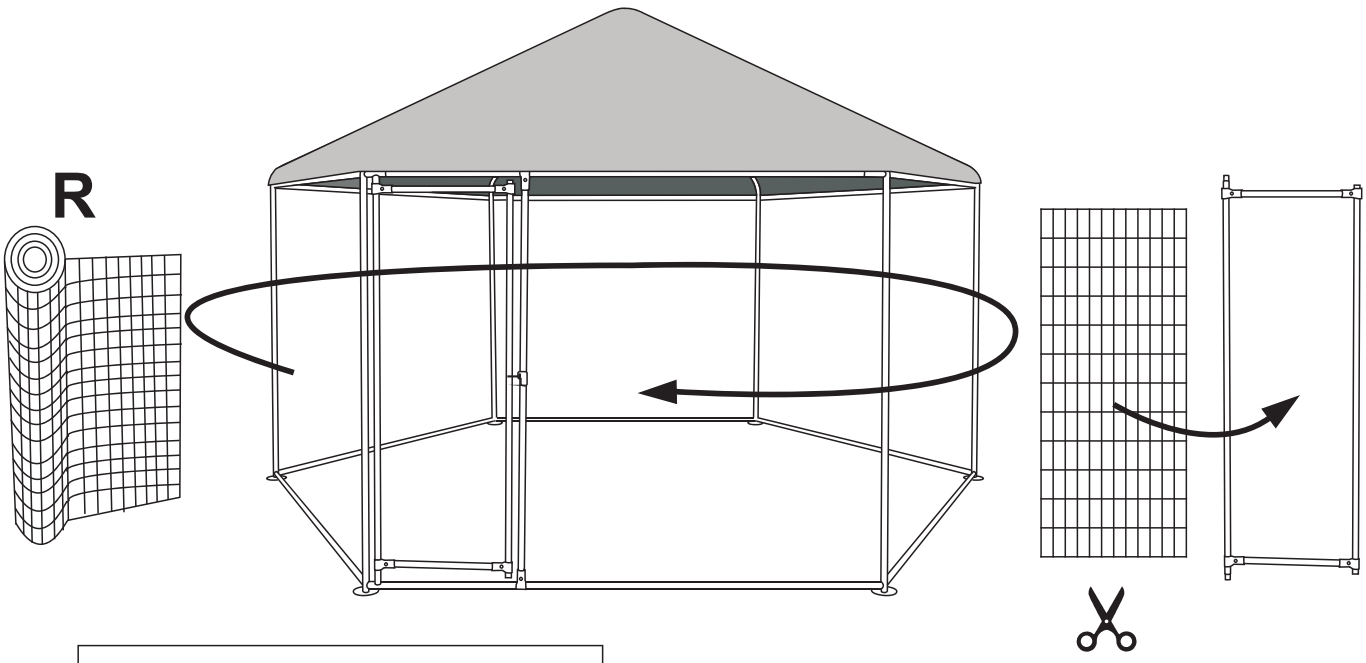

U

