

INSTRUCCIONES DE ARMADO / ASSEMBLY INSTRUCTIONS

ESTANTE HOME E2 / HOME BOOKSHELF E2

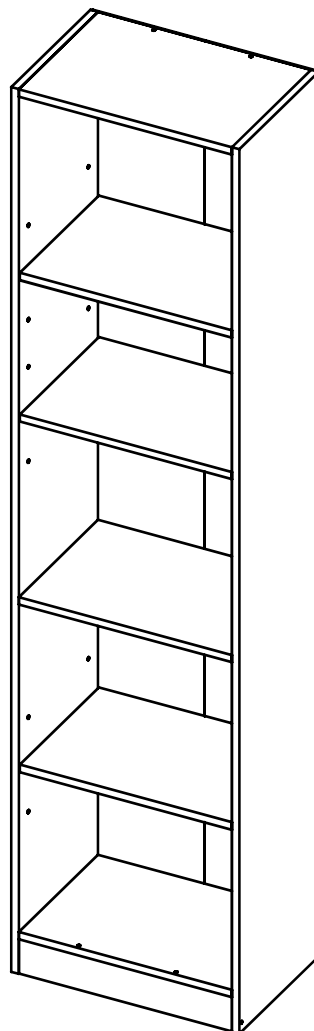

LOT N°

RTA[®]
m u e b l e s

Tel: (602) 695 9581 / 695 91 81 | EXT 118
La Nueva Estancia, Yumbo - Valle del Cauca - Colombia
www.rta.com.co

¡ATENCIÓN! / ATTENTION!

En las próximas páginas está el contenido de las piezas y herrajes del mueble. Asegúrate de que la cantidad de herrajes y piezas que hay en la caja sea la correcta y todo esté en buen estado. Ya que cuando el mueble esté armado no podrás realizar ninguna reposición.

On the next pages is the content of the pieces and hardware of the furniture.

Make sure the number of hardware and parts in the box is correct and everything is in good condition. When the furniture is assembled you will not be able to make any replacement

Recomendaciones Importantes / Key Recommendations

- Ensamble el mueble entre dos personas. / Assemble the cabinet between two people.
- Ensamble el mueble sobre una superficie plana y lisa, preferiblemente sobre un tapete o el cartón de la caja. / Assemble the cabinet on a flat smooth surface, preferably on a carpeted floor or the box carton.
- Se recomienda utilizar un destornillador eléctrico para facilitar el ensamble / It is recommended to use an electric screwdriver to facilitate assembly.

Herramientas Necesarias / Required Tools



Destornillador de estrella
Phillips Head
Screwdriver



Destornillador de pala
Flat Head
Screwdriver

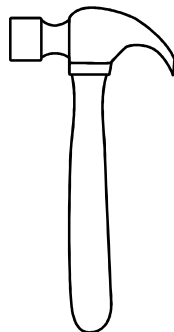

Martillo
Hammer

Herrajes Básicos / Basic Hardware

Aplica estas instrucciones cada vez que vayas a utilizar uno de estos herrajes durante el armado. / Apply these instructions everytime you're using one of these connectors during the assembly.

Tarugos / Wood Dowels

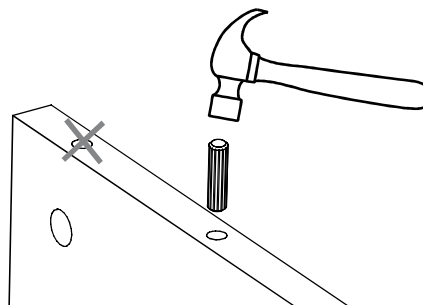

1. Inserta el tarugo en la perforación indicada y golpéalo suavemente hasta que llegue hasta el final de la perforación. / Put in the dowel inside the indicated hole and softly hit it until it's fully inside.

2. Verifica que NO se inserte el tarugo en la perforación de la caja minifix. / Verify that the dowel is NOT inserted into the perforation of the minifix cam.

Minifix y Pernos / Minifix Cam & Spreading Bolt

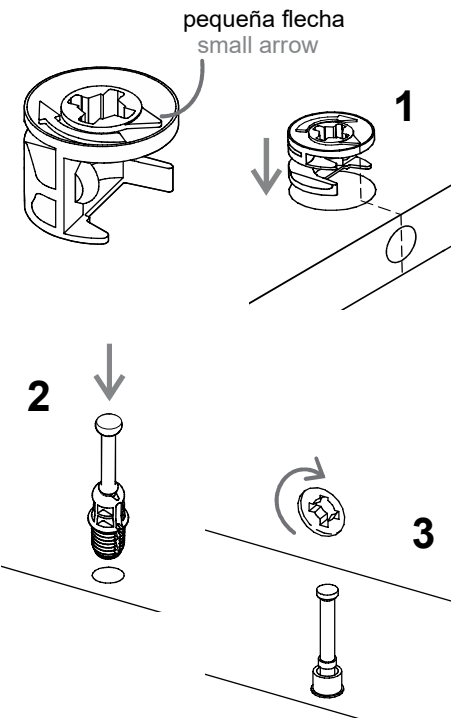







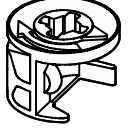

1. La caja minifix tiene una pequeña flecha en su parte superior, se debe insertar las cajas minifix con la flecha apuntando hacia la perforación que hay en el borde de la pieza. / The Minifix cam has a little arrow on its upper surface you should insert these cams with the little arrow pointing towards the drilling on the panel's edge.

2. Se debe insertar el perno con la parte plástica hacia abajo. / The spreading bolt should be put with the black plastic part facing down.

3. Luego de unir las piezas, se deben girar 180° las cajas minifix con un destornillador de estrella para ajustar y asegurar el ensamble. / After joining two panels together you should turn the cams 180° with a phillips head screwdriver to adjust and secure the joint.

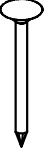
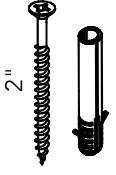
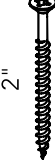
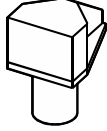
Herrajes / Hardware

			
Tarugo / Wood dowel	Perno Minifix / Spreading Bolt	Caja Minifix / Minifix Cam	Tapa Minifix / Cover Caps
x10	x6	x6	x16
			
Puntilla / Nail	Deslizador Puntilla / Nail-on Glide	Tachuela / tack	Chazo + Tornillo/ Wall anchor + screw
x3	x4	x20	x2
			
Tornillo ensamble / Drywall screw	Soporte entrepáño / Shelf support	Grapa para fondo / Rear Panel	
x8	x12	x3	

Cargas Máximas / Max Suggested Loads

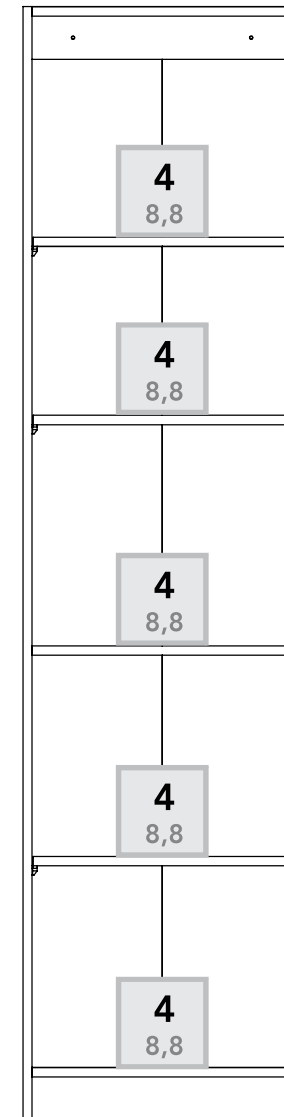

*Peso en Kg / Weight in Kg.

*Peso en Libras / Weight in Lb

Piezas de Armado / Assembly Parts

A - x1
B - x1
C - x1
D - x1
E - x3
F - x1
G - x1
H - x1
I - x1
I - x2

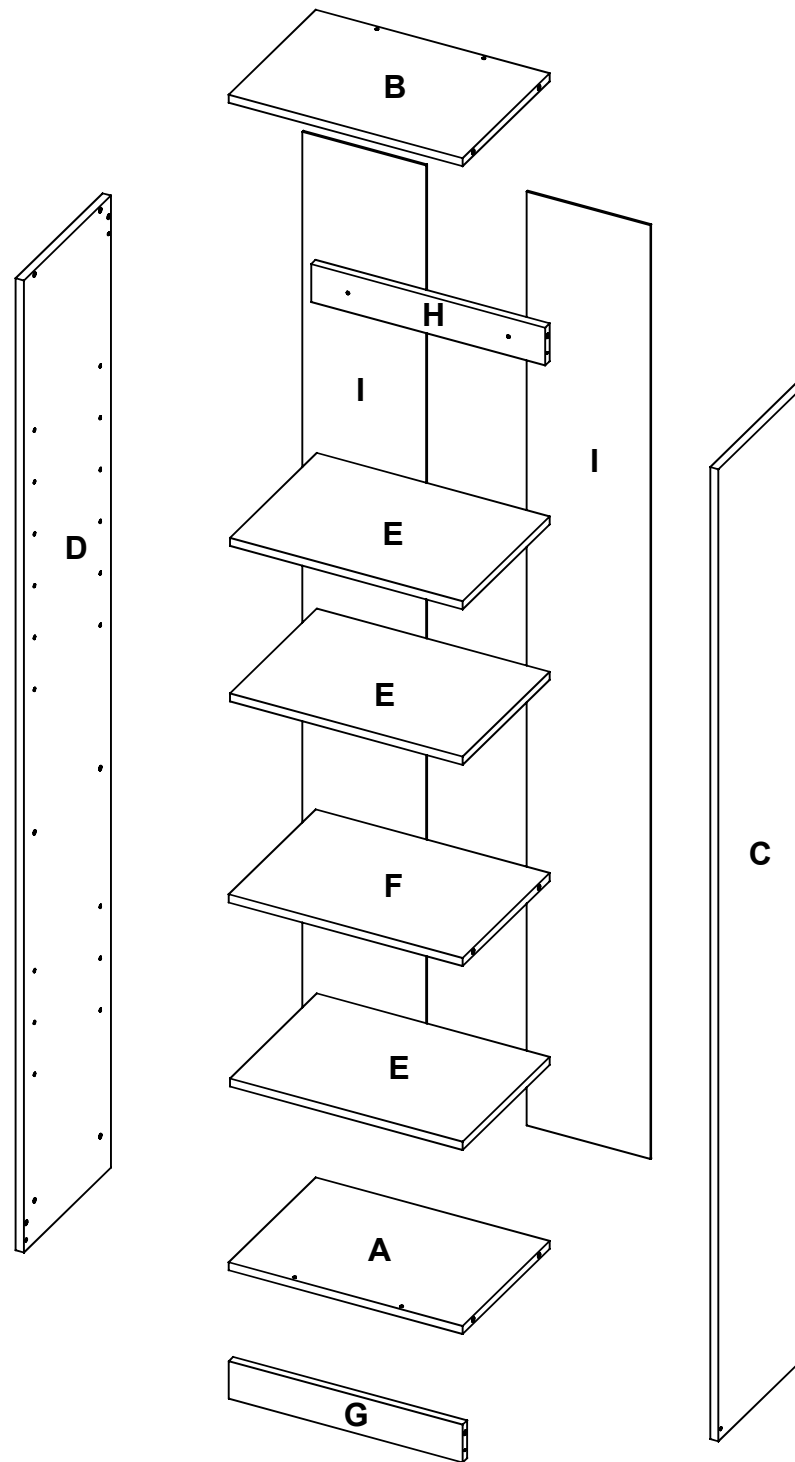

1



Advertencia: Este mueble debe ir anclado a pared para su correcto funcionamiento (revisar paso 13)
Warning: This furniture must be anchored to the wall for proper operation (check step 13)

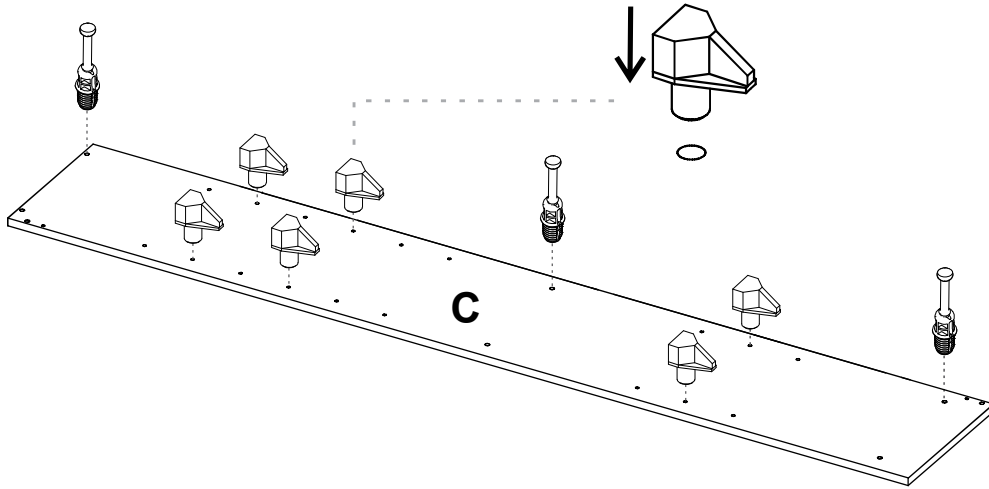

2

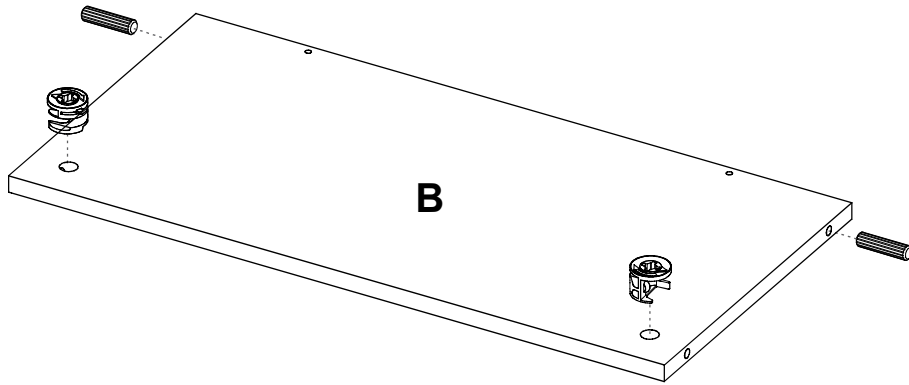

3

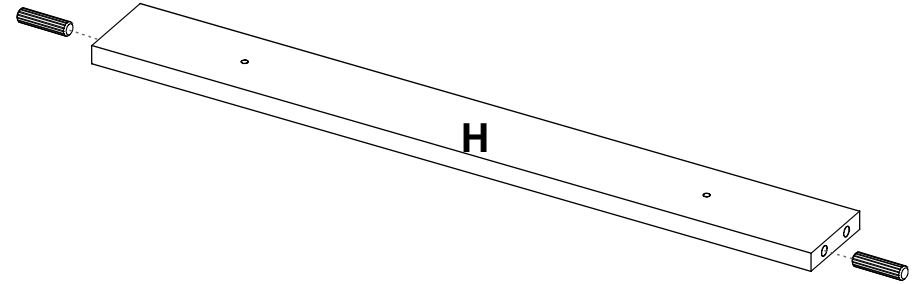

4

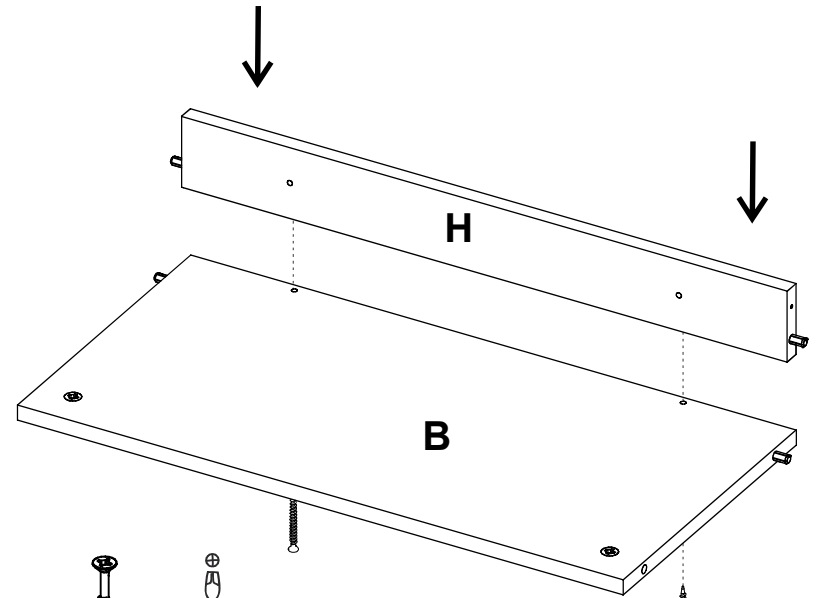

Tornillo
ensamble 2"
Drywall
screw 2"



5

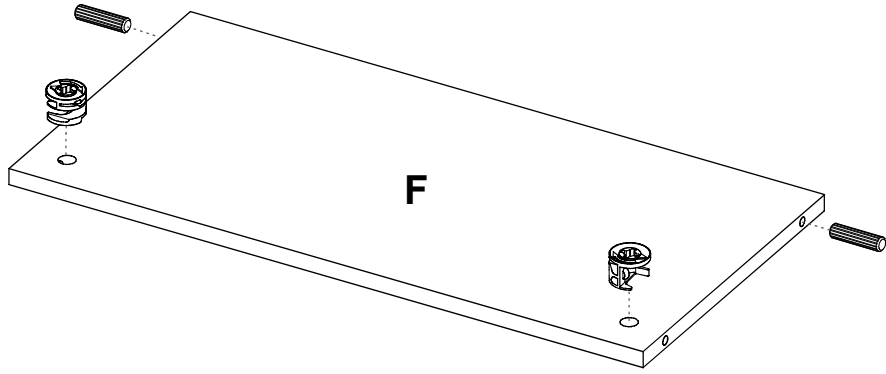

6

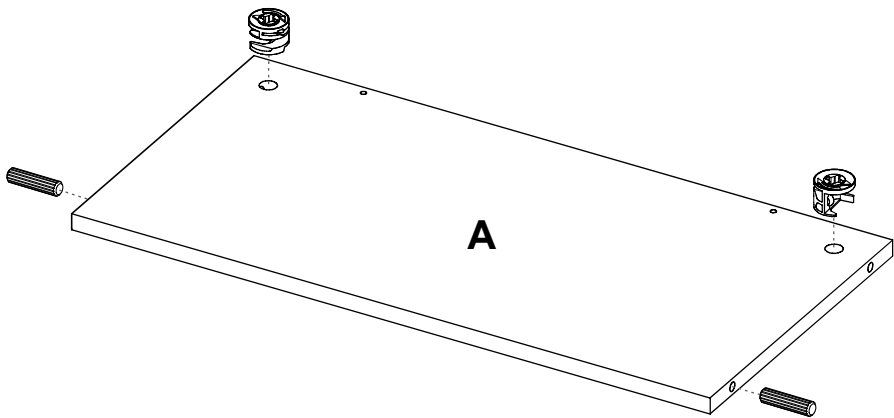

7

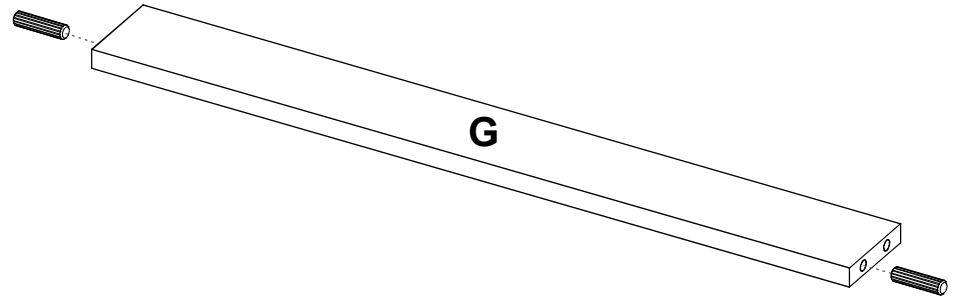

8

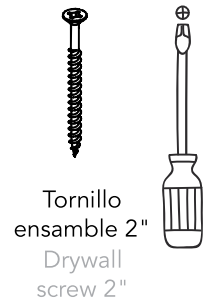
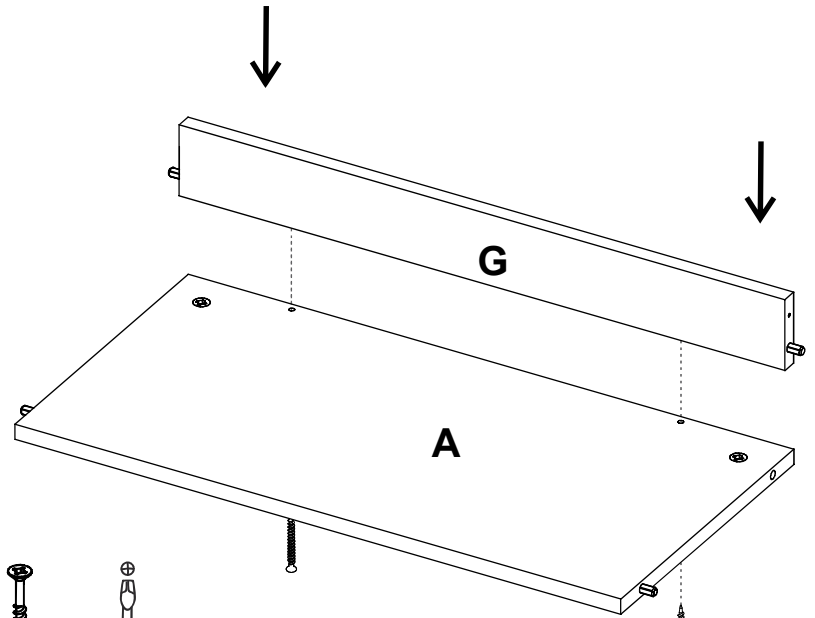

9

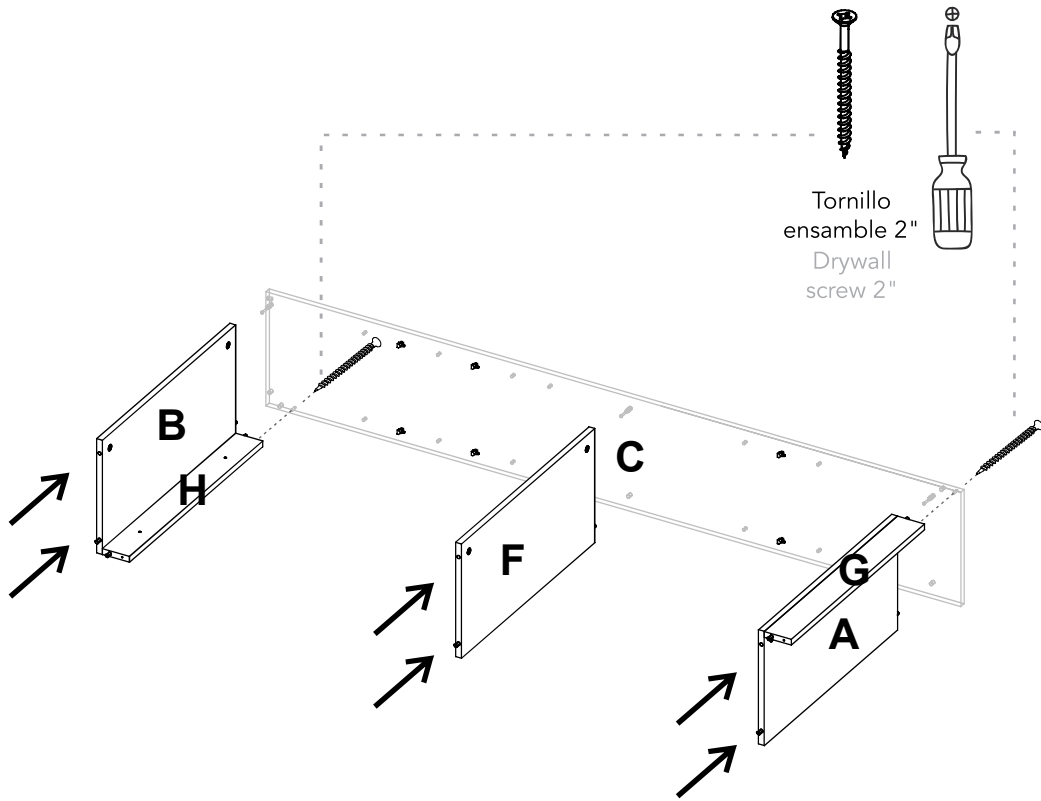

10

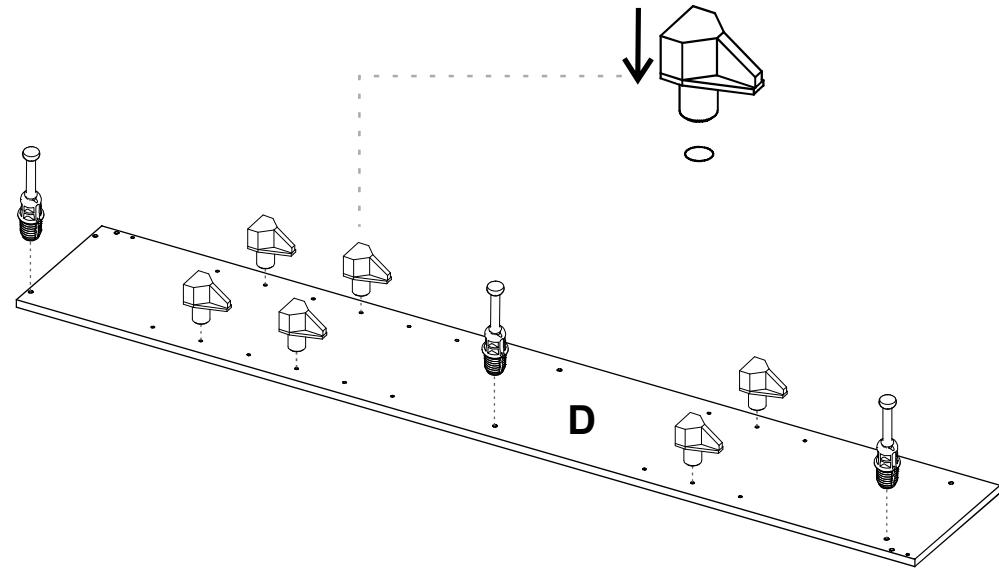

11

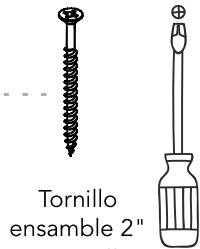
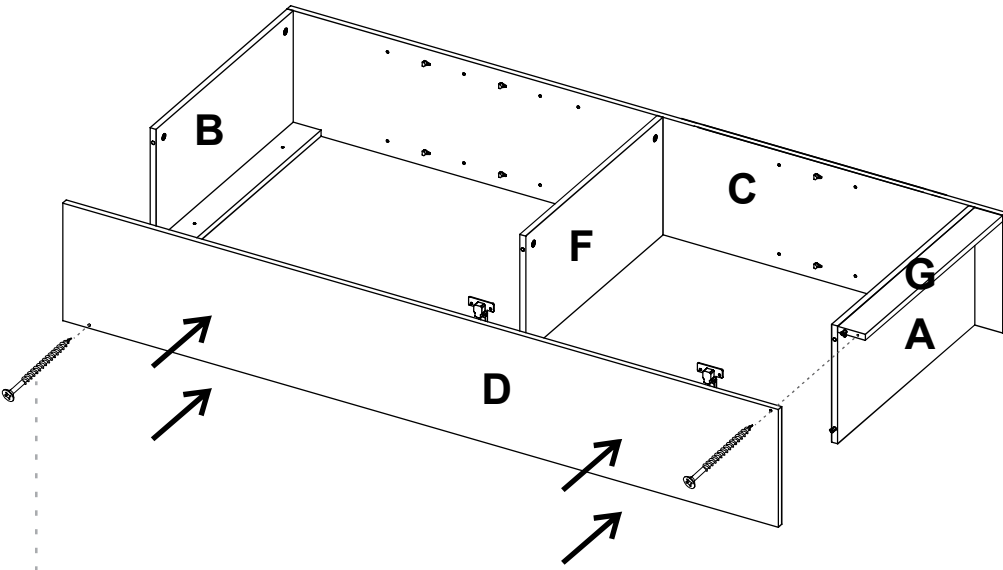

Tornillo
ensamble 2"
Drywall
screw 2"



¡Con mucho cuidado!
very carefully!

12

Ubicar las tachuelas del centro a esta distancia
Locate the tacks of the center at this distance.

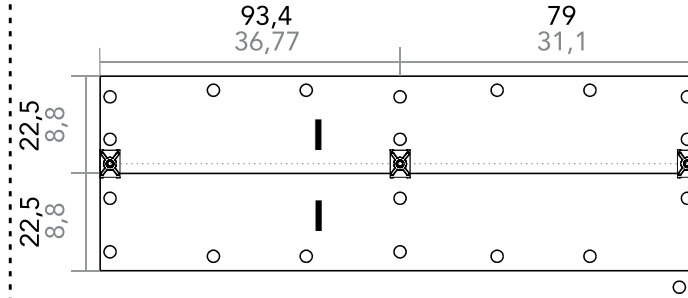

Procure que la perforación de la grapa para el fondo no quede entre la unión de las piezas I, para que estas no queden separadas.
Make sure that the perforation of the rear panel does not remain between the union of the pieces I, so that they do not separate.

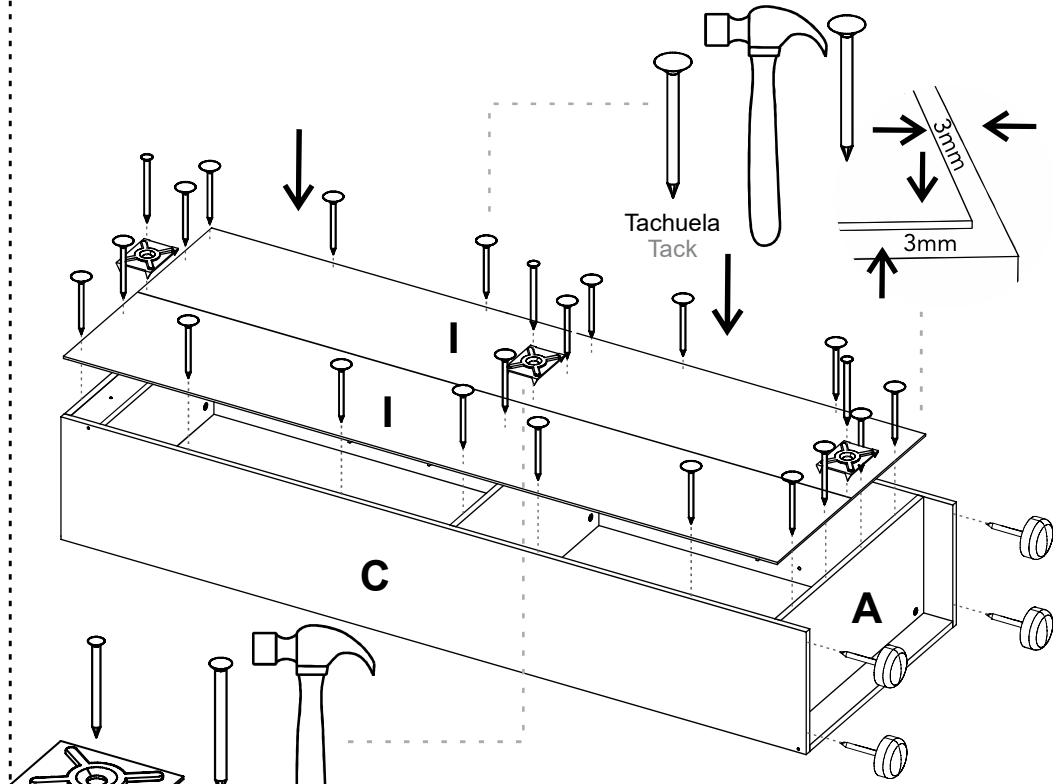

Puntilla
Nail

Voltea el mueble
Turn over the cabinet

¡Con mucho cuidado!
very carefully!

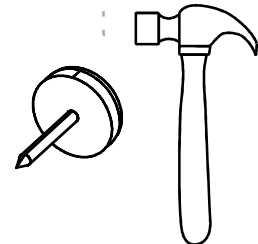

13

Fija el mueble a la pared Fix your cabinet to the wall

- 1 En la pared, mide y marca los puntos que te indicamos abajo.
On the wall, measure and mark the points shown below.
- 2 Debes perforar en los puntos con taladro y una broca de 5/16".
Drill on the markings with a 5/16" drill bit.
- 3 Inserta los chazos plásticos en las perforaciones.
Insert the wall anchors inside the drillings.
- 4 Ubica el mueble y asegúralo con los tornillos.
Place the cabinet and secure it with the screws.

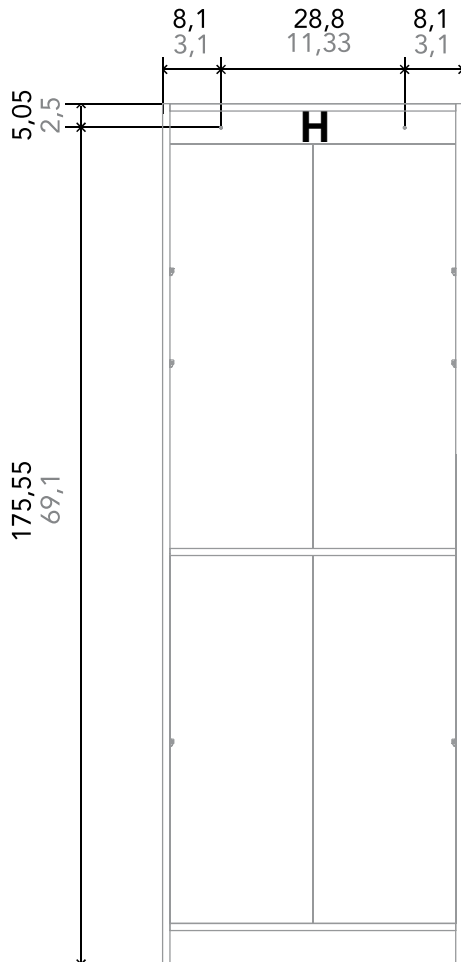
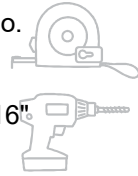

*Medidas en cm / Measurements in cm
*Medidas en pulgadas / Measurements in inches

14

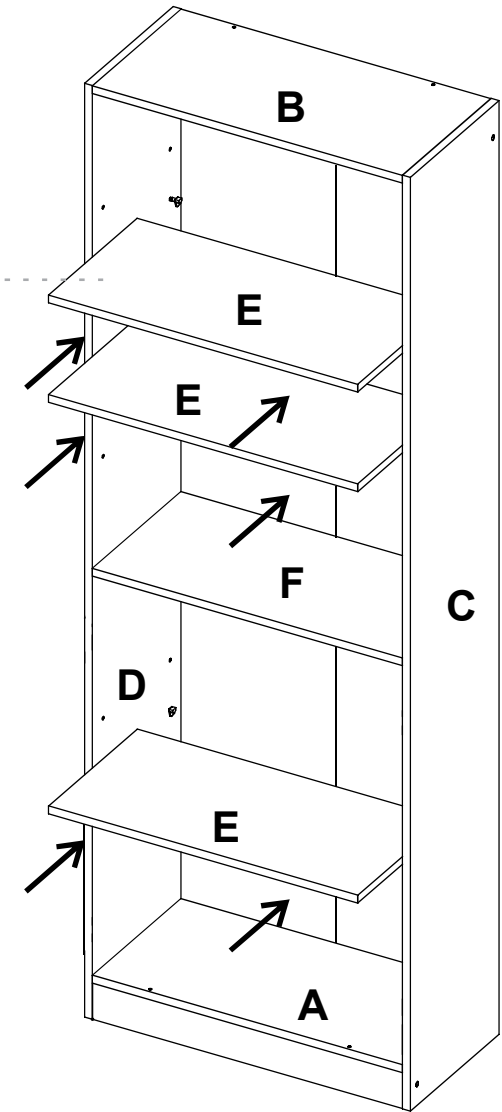

Desliza el entrepaño dentro del mueble.
Slide the shelf inside the cabinet.

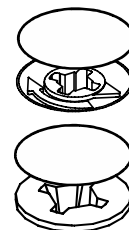

Después de ajustar todas las cajas minifix y los tornillos, cúbralas con las tapas adhesivas.
After you finish the adjustment of the cams and screws, cover them with the cover caps.



Al terminar de armar, desprenda las letras adhesivas.
After you finish assembling the cabinet, take off the adhesive letters.



Advertencia: Este mueble debe ir anclado a pared para su correcto funcionamiento.
Warning: This furniture must be anchored to the wall for proper operation.