

# INSTRUCTION

WF318835  
WF318836

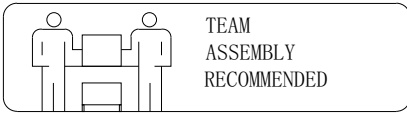
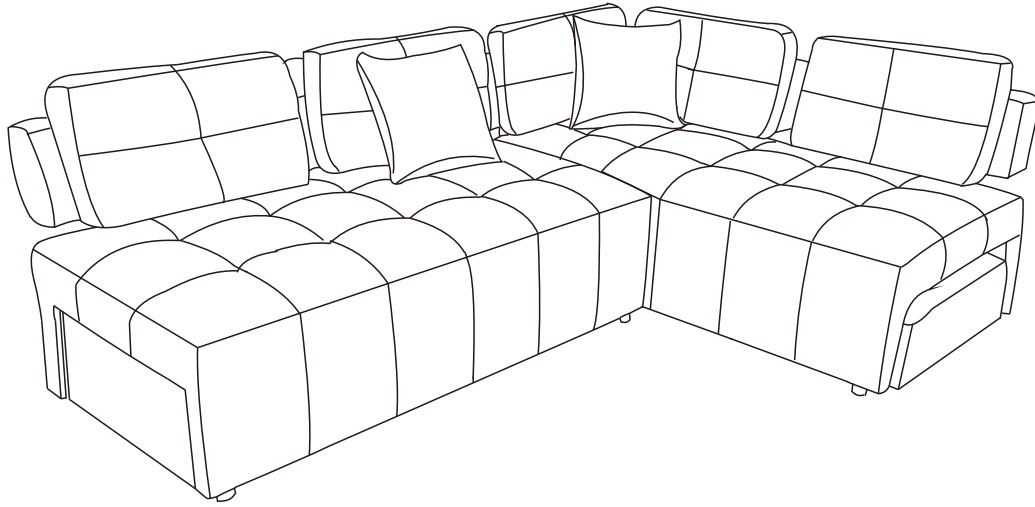

sofa

## PARTS LIST

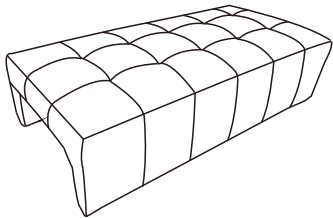

A X 1pc

Seat

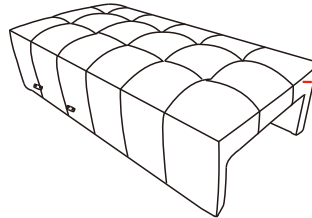

B X 1pc

Seat

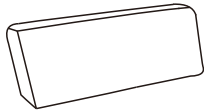

C X 5pcs

Backrest

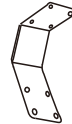

D X 5pcs

Back connect metal



E X 40pcs

Screws M6\*2.5



F X 1pc

Allen Key

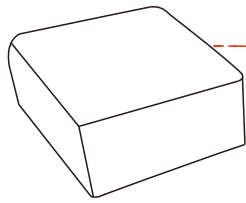

G X 2pcs

ottoman



H X 8pcs

legs

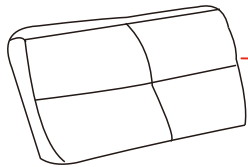

I X 5pcs

Back cushions

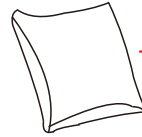

J X 2pcs

Pillows

STEP 1

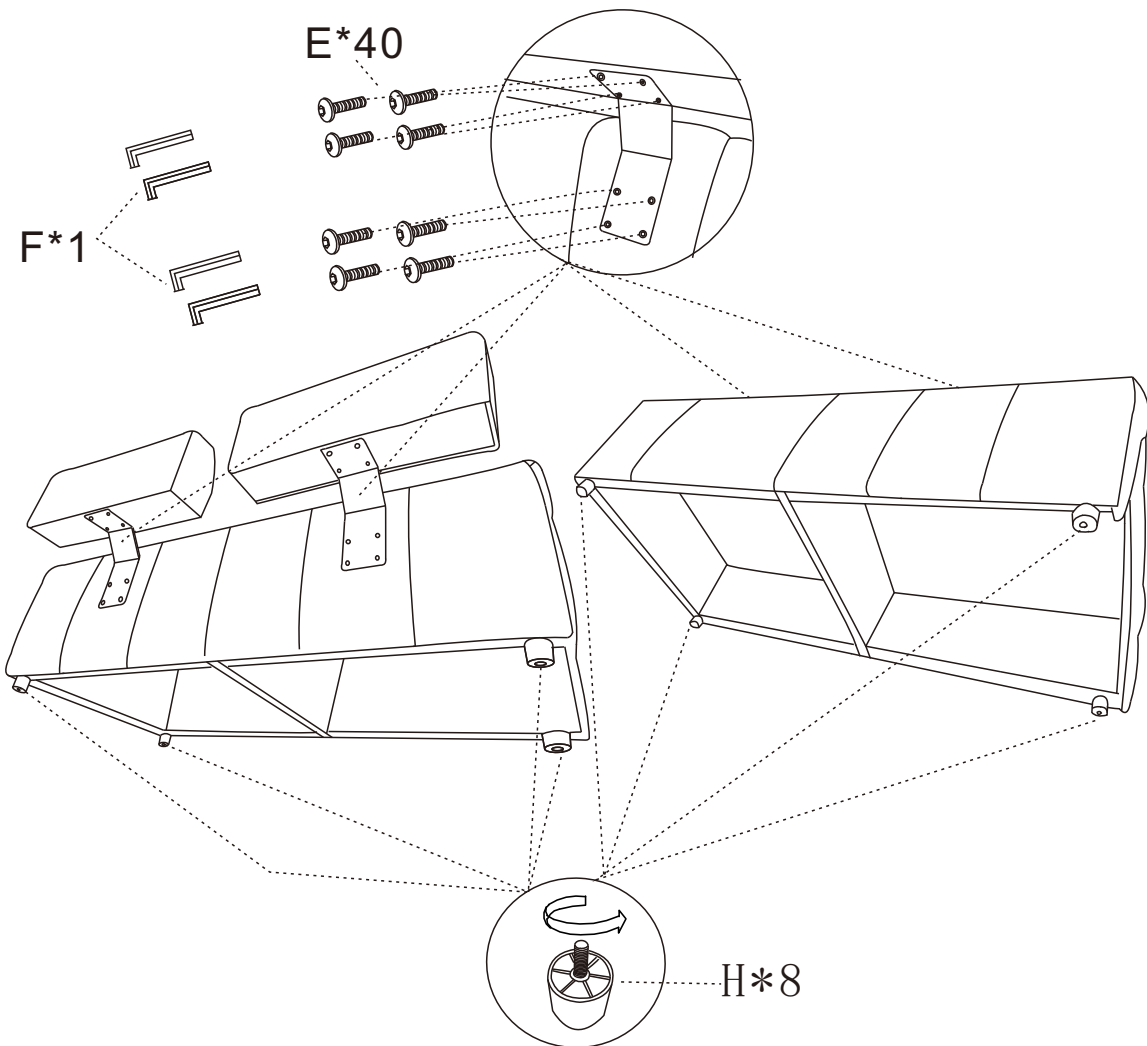

STEP 2

SHIP BY A BOX

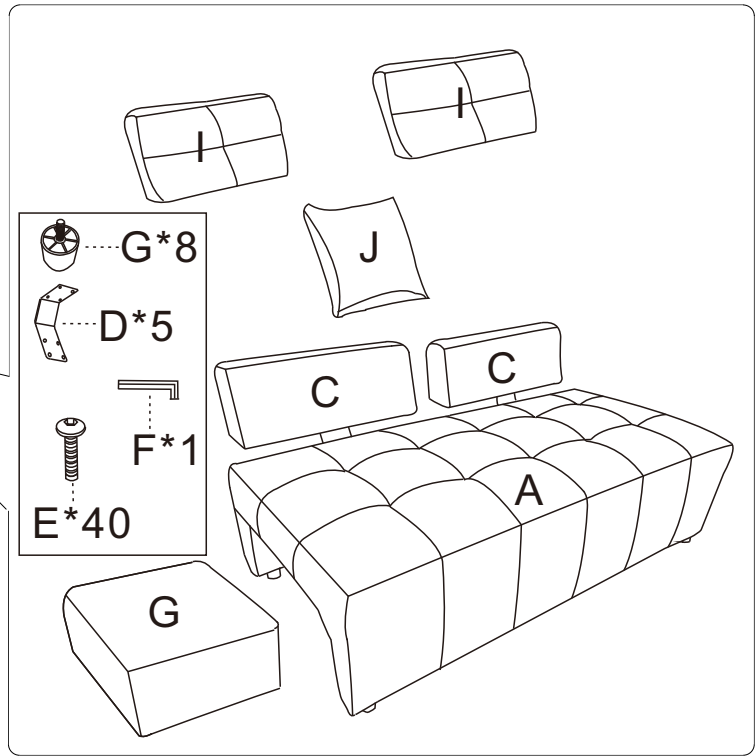
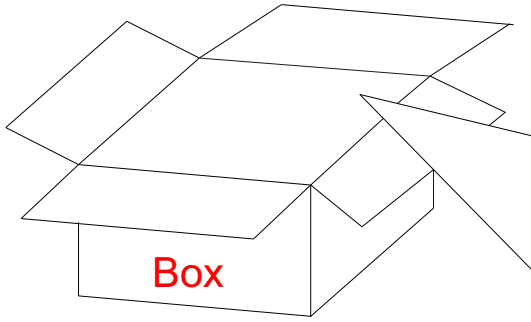

STEP 3

SHIP BY B BOX

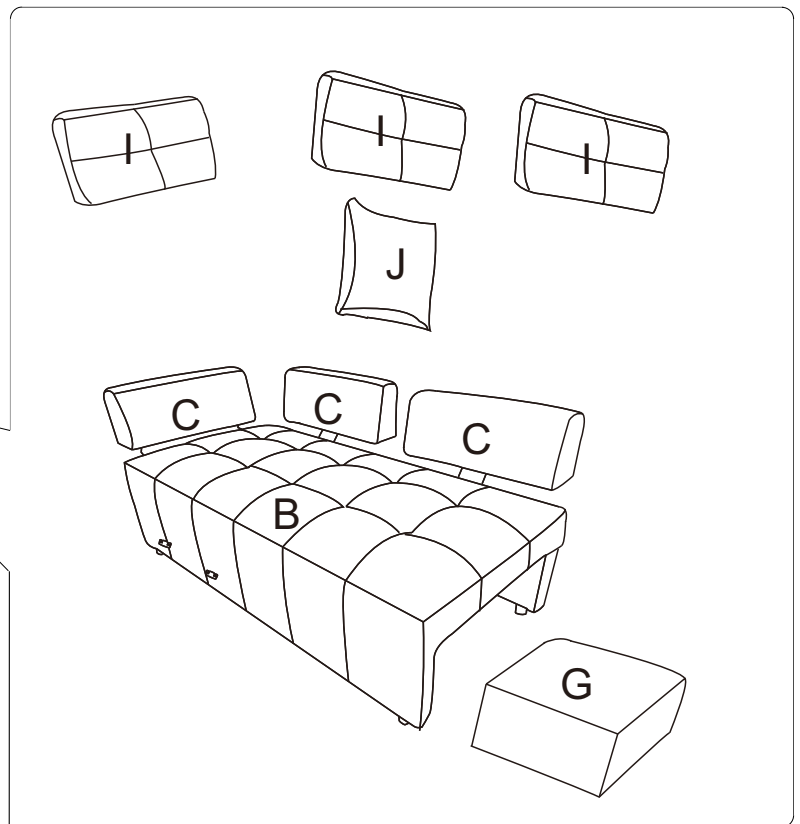
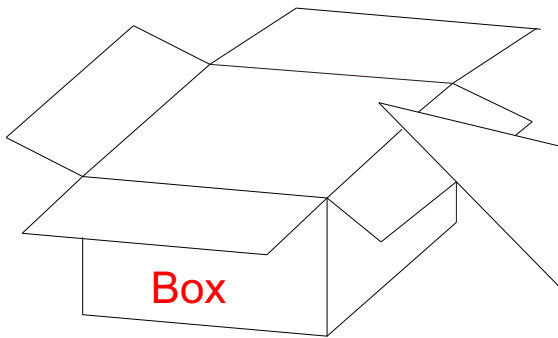

STEP 4

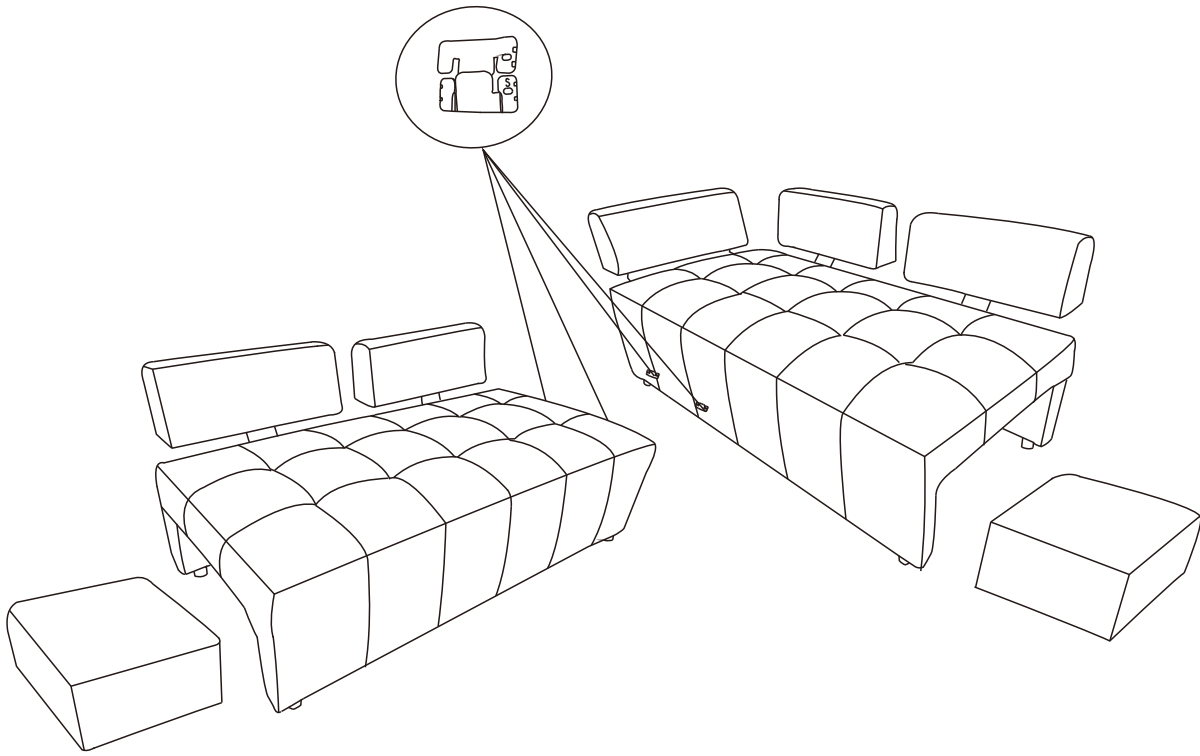

STEP 5

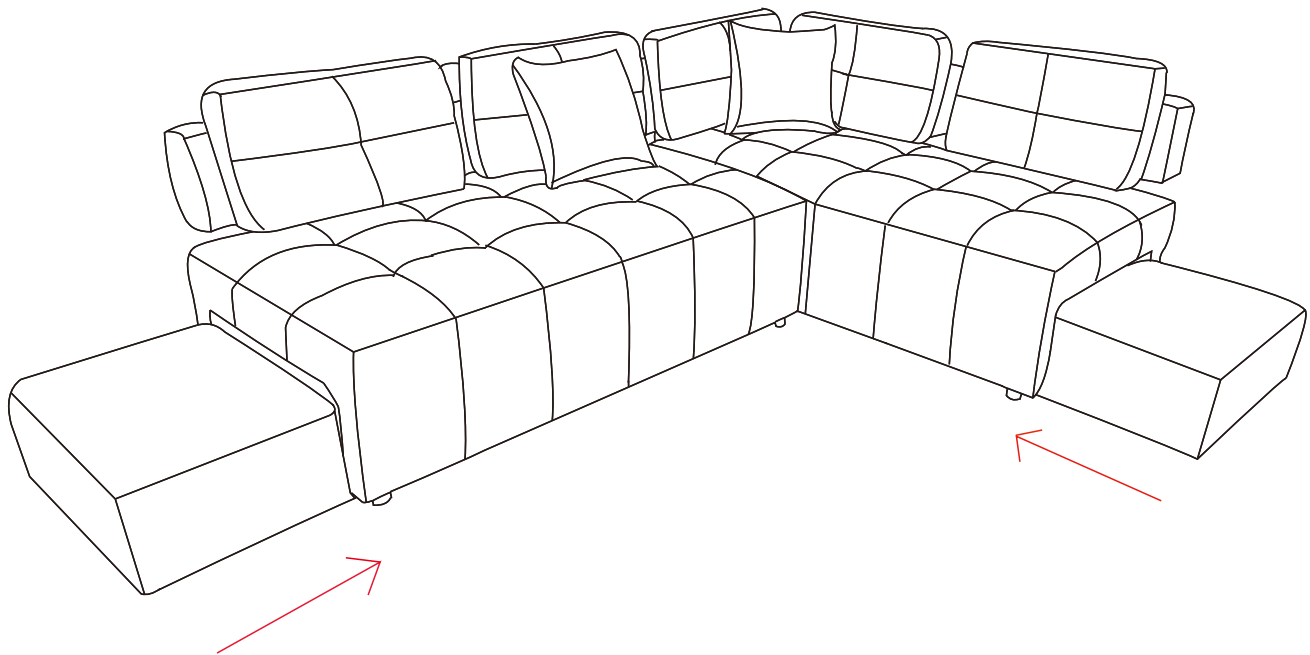

PLACE THE BACK  
PILLOW ON THE SOFA  
AS SHOWN, OR MIX  
AND MATCH