

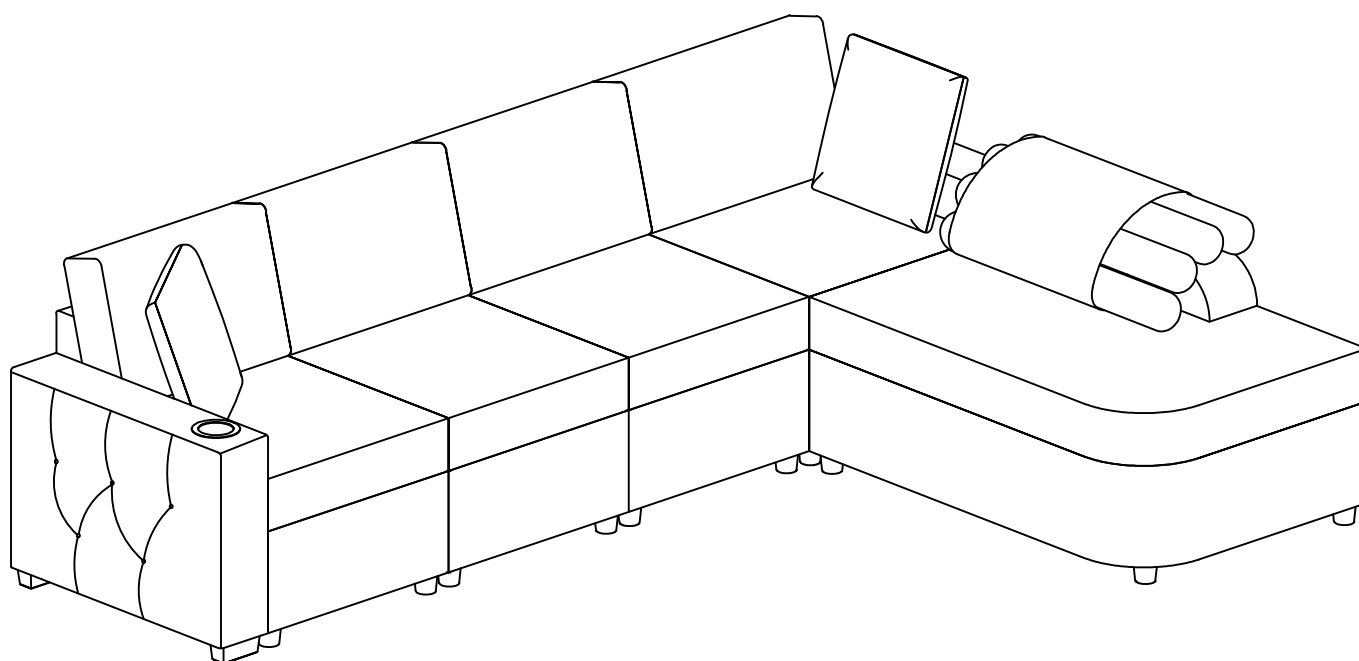

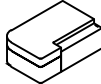



ASSEMBLY INSTRUCTION



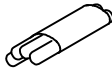

ITEM NO.: WF313955-WF313956-WF313957-WF313958





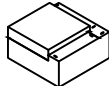
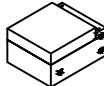

WF313955-COMPONENT LIST

A		1	Chaise Body
B		1	Backrest of A
C		1	Finger Pillow
D		2	Pillow
E		4	Round legs 4pcs
J		1	Backrest of G





WF313956-COMPONENT LIST

G		1	Corner Frame
F		1	Single Frame
H		2	Backrest
I		2	Back Cushion
E		8	Round legs 8pcs

WF313957-COMPONENT LIST

NO.	DRAWING	QTY	DESCRIPTION
G		2	Single Frame
H		2	Backrest
I		2	Back Cushion
E		8	Round legs 8pcs

WF313958-COMPONENT LIST

K		1	Arm
L		2	Rectangular legs 2 pcs of Arm
M		4	Bolt 5/16"X40mm X 4PCS
N		1	Allen key 1PC

PARTS LIST

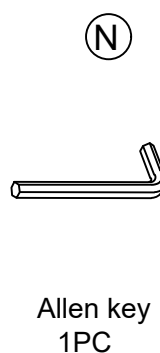
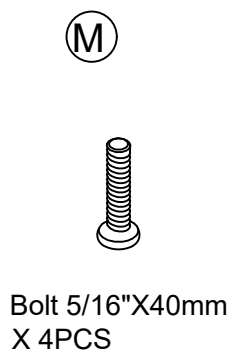
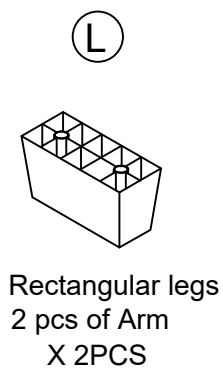
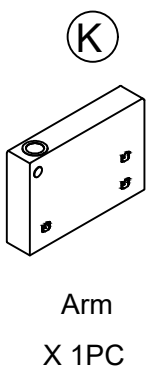
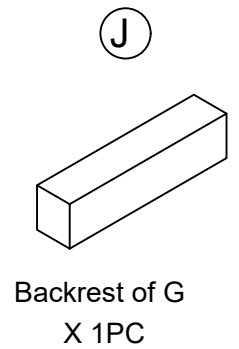
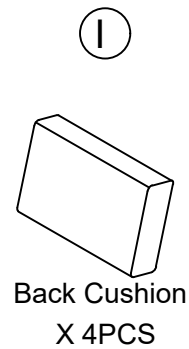
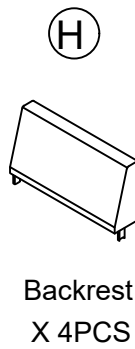
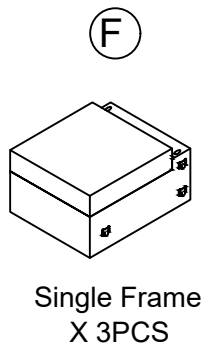
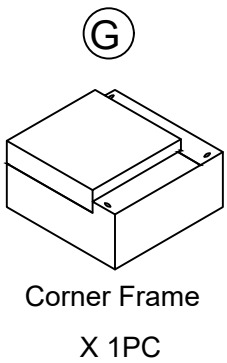
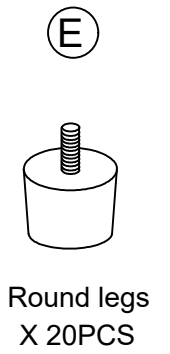
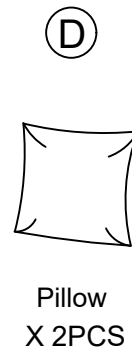
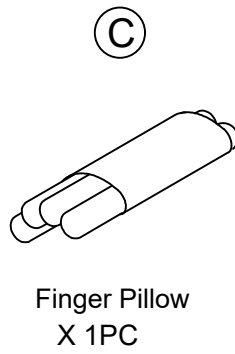
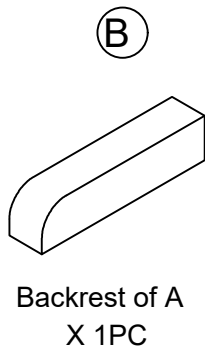
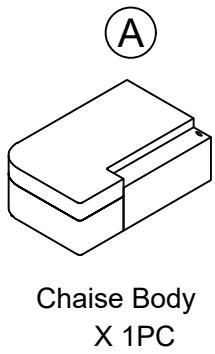
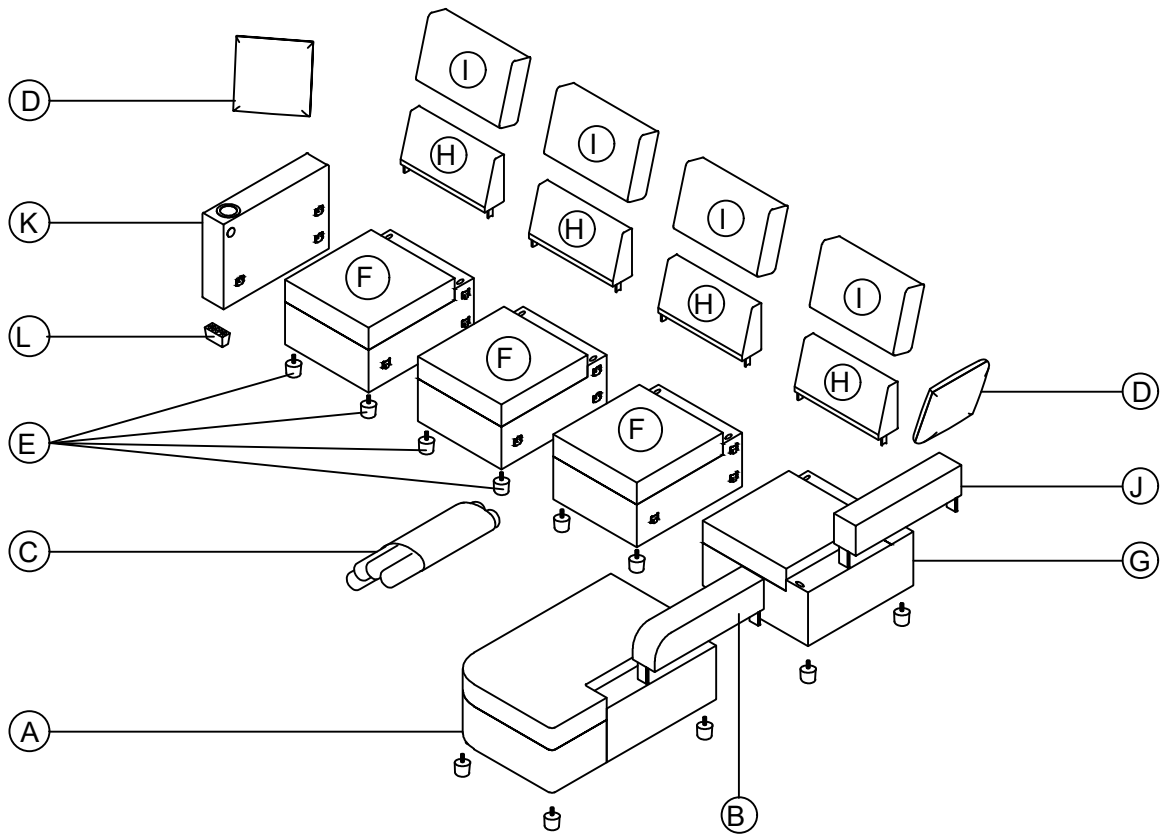

STEP 1:

1.1 Attach L x2 to K x1

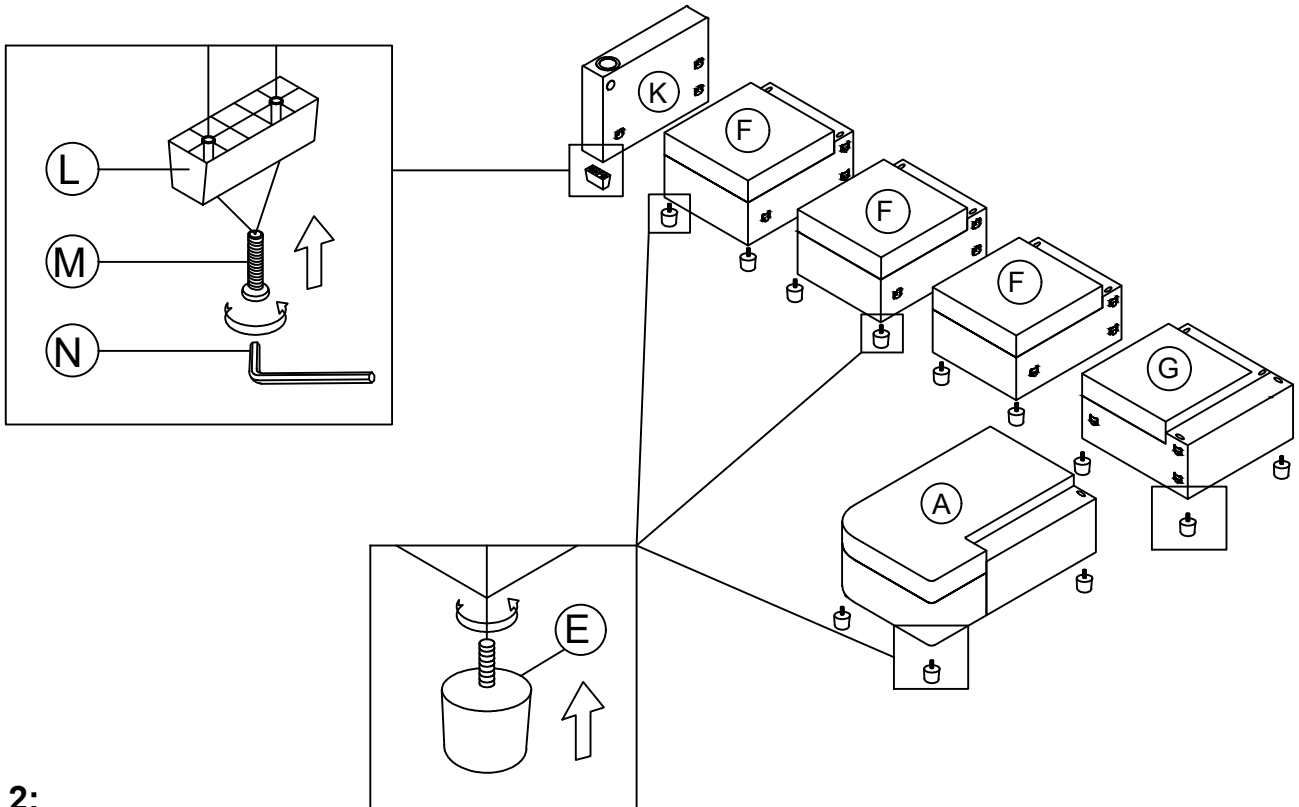

STEP 2:

2.1 Attach E x 20 to A x1 & Fx3 & Gx1

STEP 5:

- 5.1 Attach H x4 to F x3
- 5.2 Attach K x1 to F x1
- 5.3 Attach J x1 to G x1
- 5.4 Attach B x1 to A x1

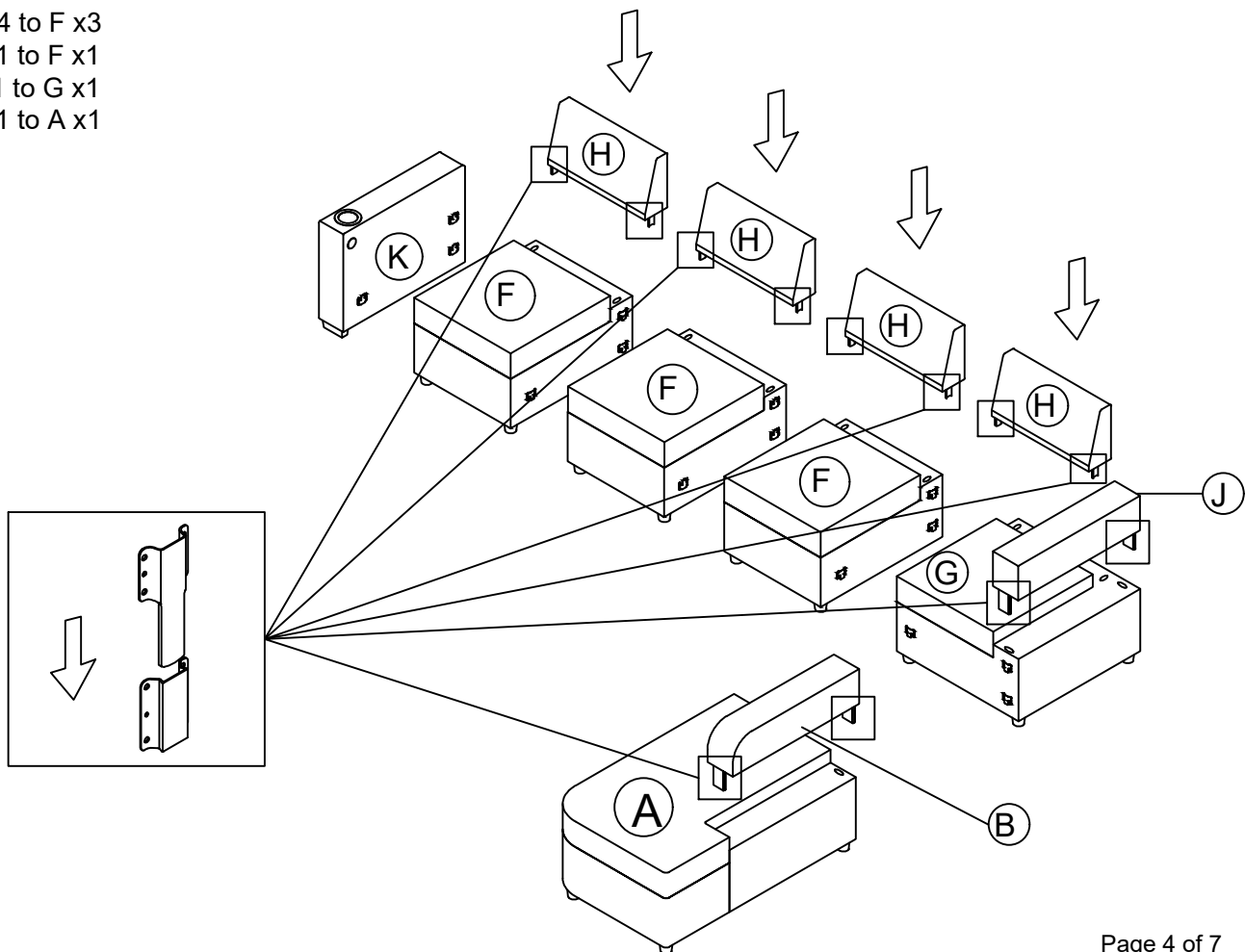

STEP 6:

- 6.1 Attach G x1 to A x1
- 6.2 Attach F x1 to G x1

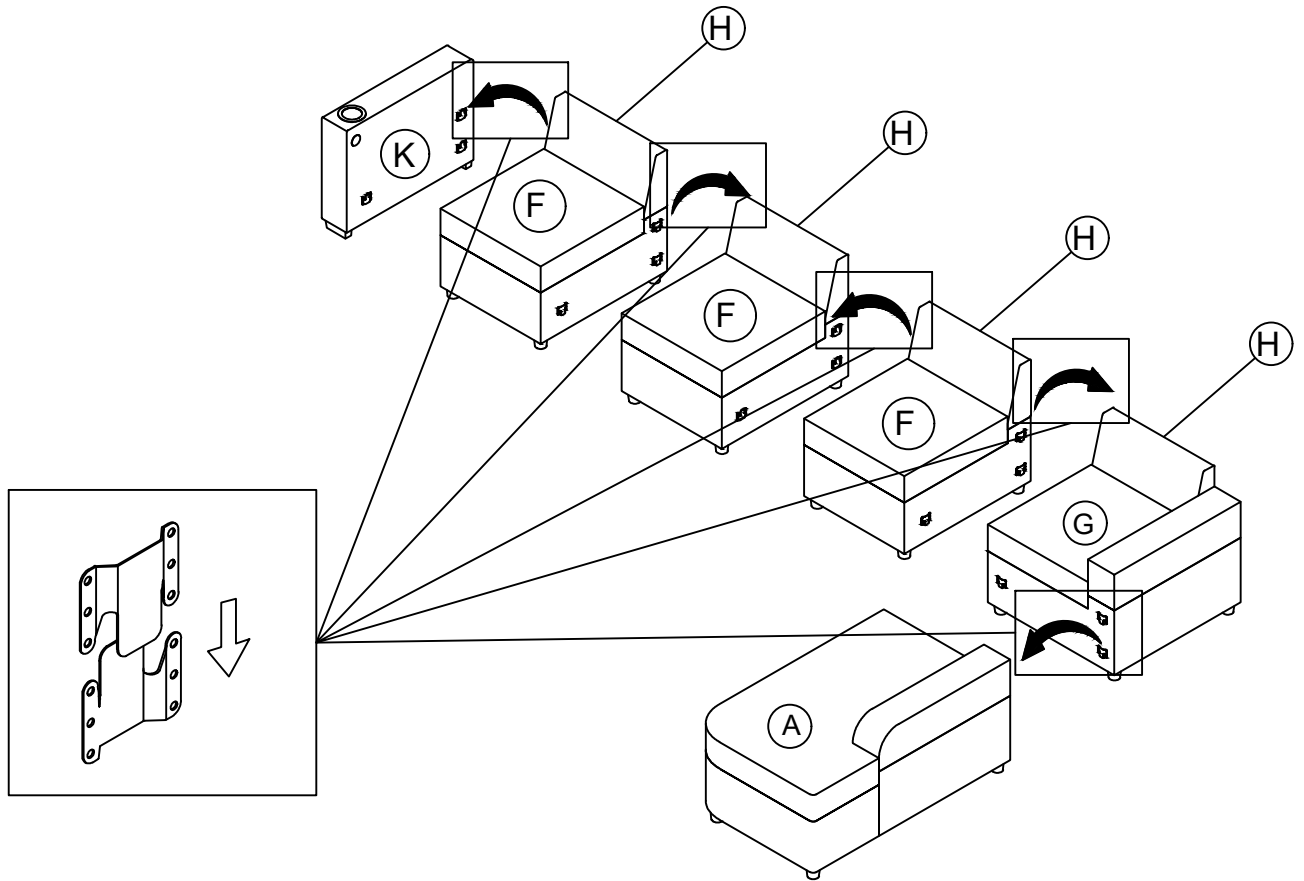

STEP 7:

- 7. Attach D x4 to C x4

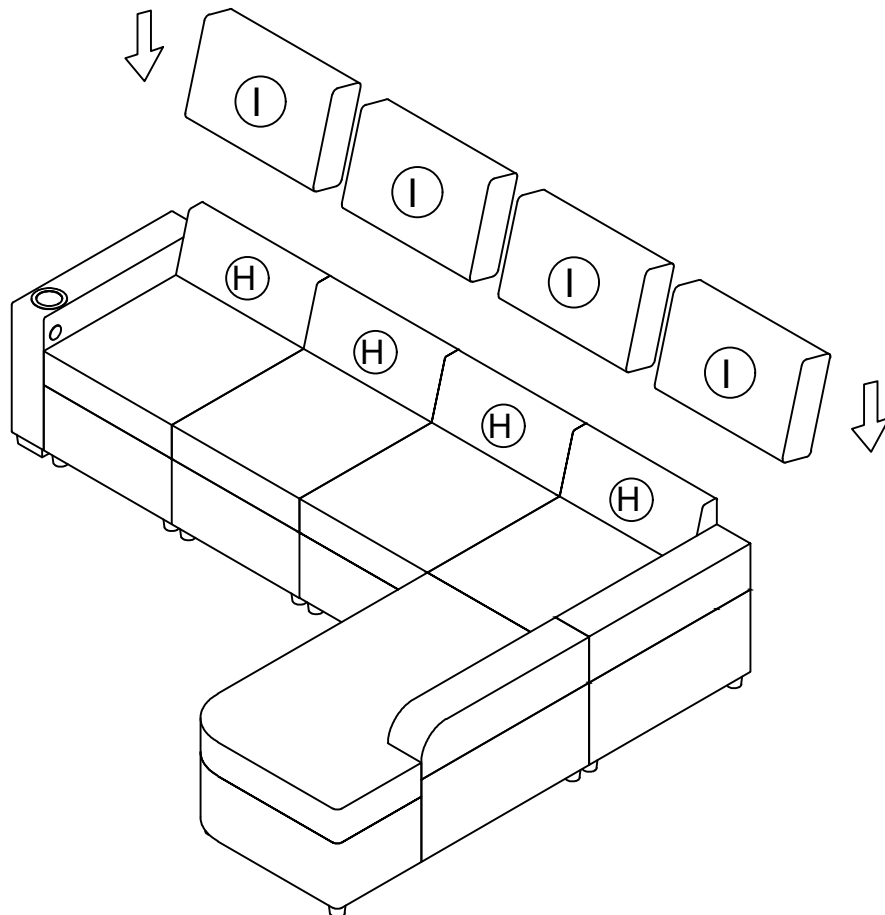

STEP 8:

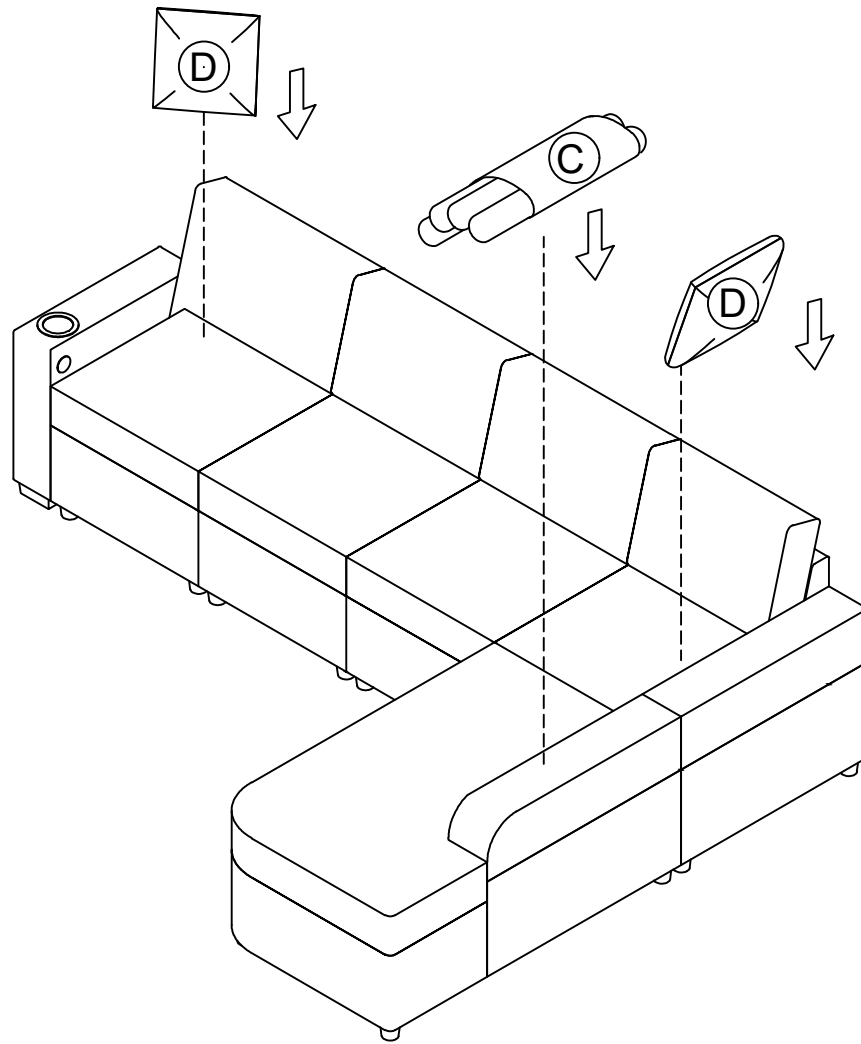

Helpful Hints

- Move your new furniture carefully, with two people lifting and carrying the unit to its new location.
- Your furniture can be disassembled and reassembled to move.
- Clean the product with a soft damp cloth. DO NOT use harsh chemicals or abrasive cleaners.

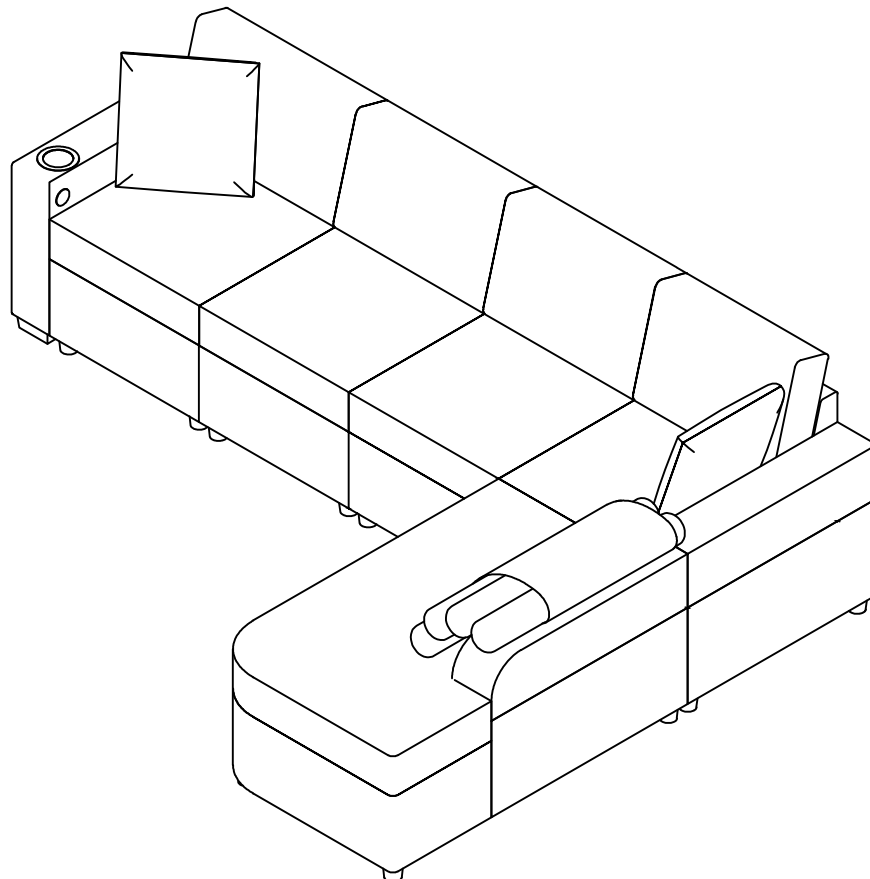

COMPLETE

