

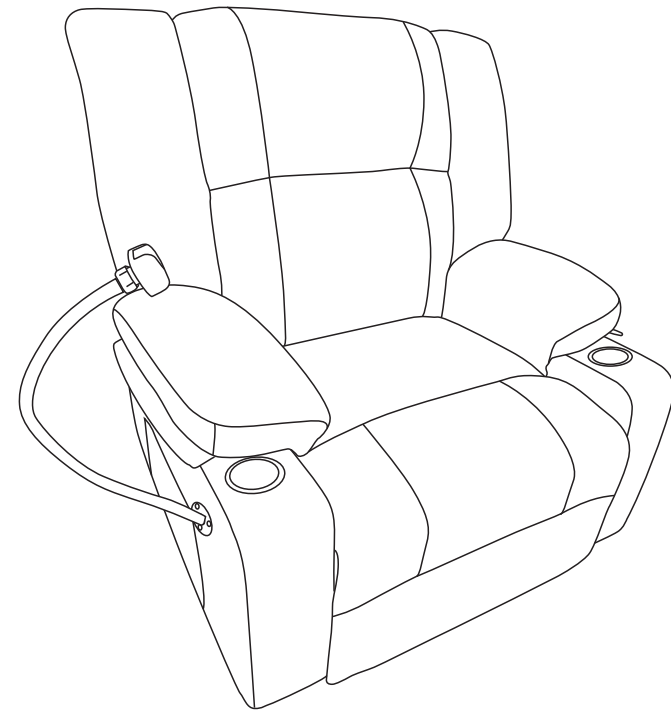











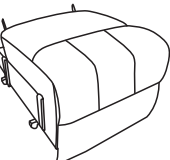

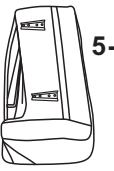
Recliner Assembly Instructions

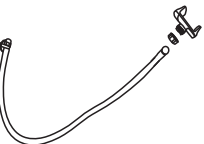
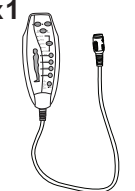

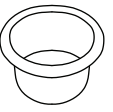
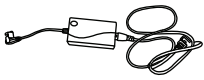
THIS INSTRUCTION BOOKLET CONTAINS **IMPORTANT** SAFETY INFORMATION.
PLEASE READ AND KEEP FOR FUTURE REFERENCE.

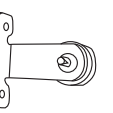
PARTS AND ACCESSORIES

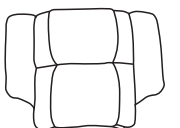
Avoid using sharp objects such as a knife to cut open packing as you may accidentally damage the upholstery.

BOX A: Wf313661			
2 x1 	3 x1 	4 x2 4-R 4-L 	5 x1 5-R 
QTY 1pc	QTY 1pc	QTY 2pc	QTY 1pc
6 x2 6-R 6-L 	7 x1 	A x1 	B x1 
QTY 2pc	QTY 1pc	QTY 1pc	QTY 1pc
C x2 	D x1 	E x1 	F x4 
QTY 2pc	QTY 1pc	QTY 1pc	QTY 4pc
BOX A: Wf313661		BOX B: Wf313662	
G x2 	H x4 	1 x1 	5 x1 5-L 
QTY 2pc	QTY 4pc	QTY 1pc	QTY 1pc

ASSEMBLY INSTRUCTIONS

CAUTION: Please check and ensure all the things are in the package. You can contact us if something is not included. We will reply within 24 hours and try our best to solve it.

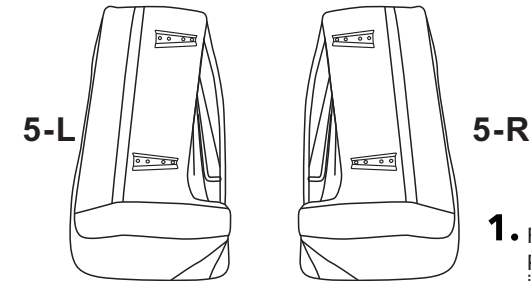

1. Find the accessories pictured on the left. Placed it on the ground for subsequent installation.

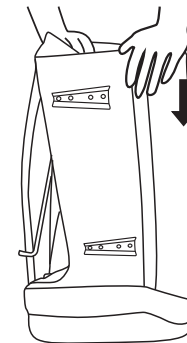

2. Hold the long board with your blue hand and open the armrest with your red hand.

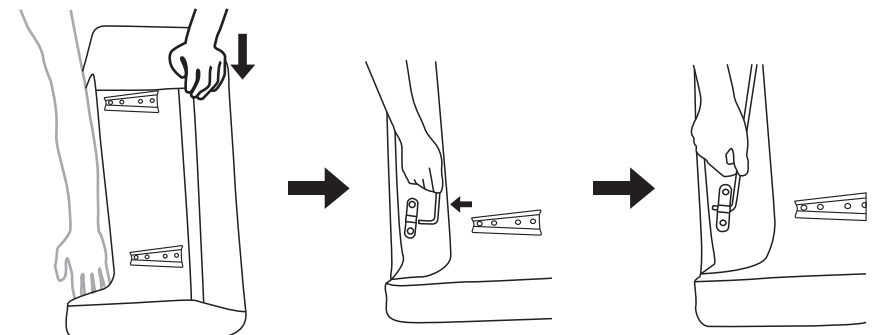

3. Place one hand on the short plate (red area) in the picture and apply downward pressure while placing the other hand on the green area to install the hook section as indicated in the picture.

4. Zipper the armrest pillow 6-L
on the wooden fram L

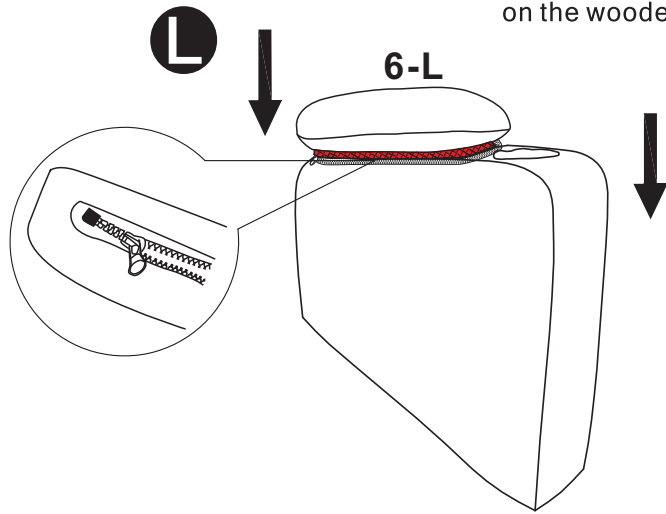

5. Zipper the armrest pillow 6-R
on the wooden fram R

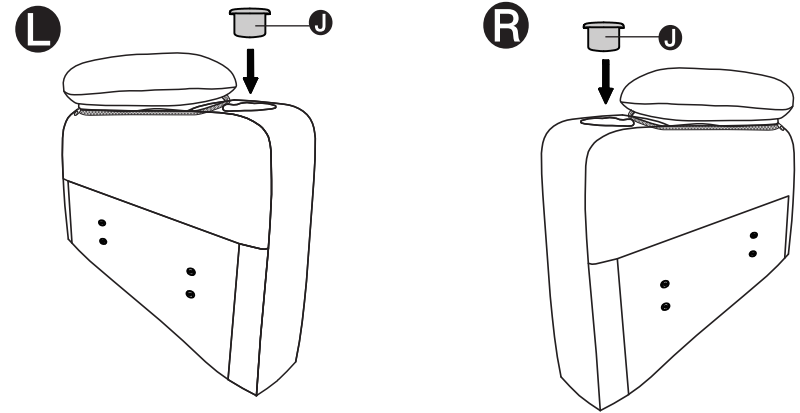
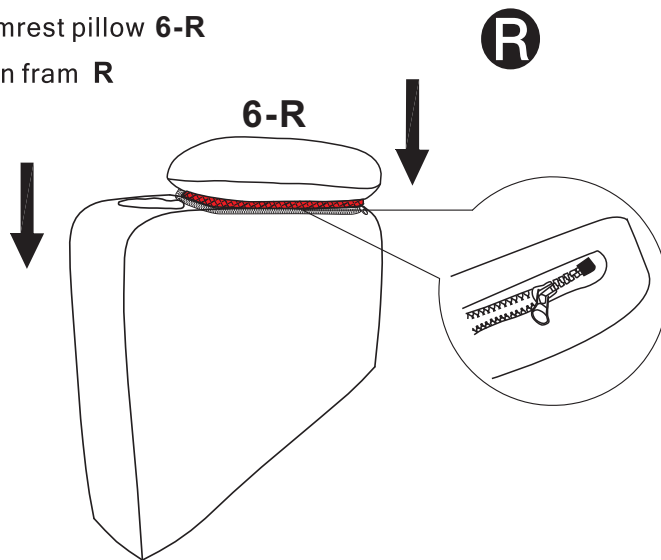

6. Install the cup holders into the armrests
on both sides.

7. Insert the metal bolts of the
2 armrests to the seat as
shown below. Ensuring they
are correctly in place.

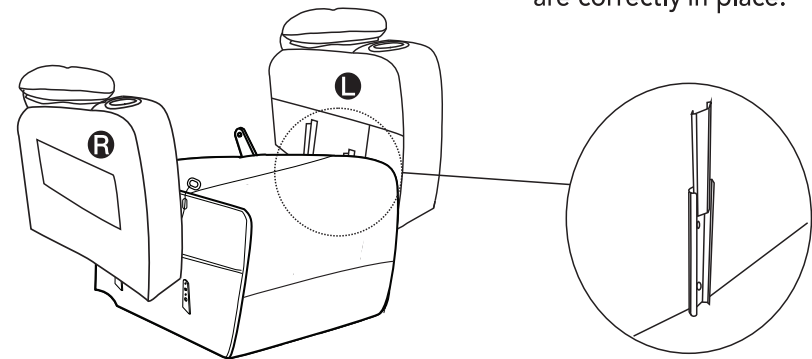

- 8.** Align the backrest iron frame with the back cushion and zipper it up.

Take out supporting feet and nuts from a accessory box. Assemble the two supporting feet as shown on the bottom of mechanism to avoid toppling and falling.

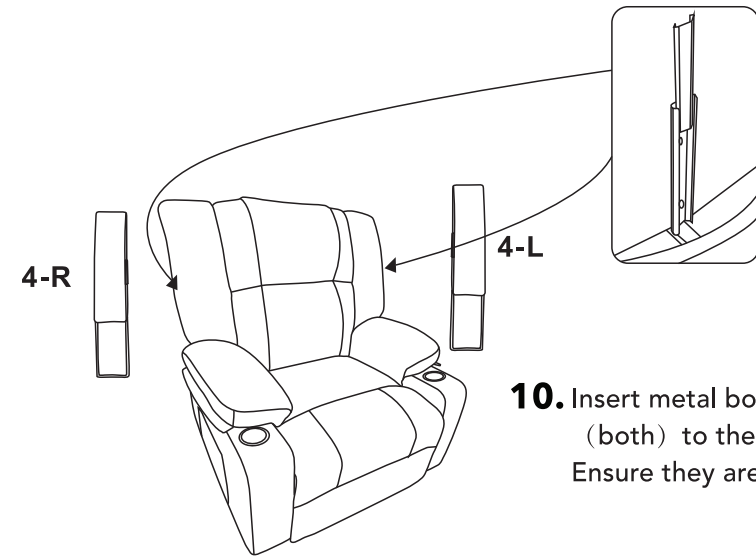
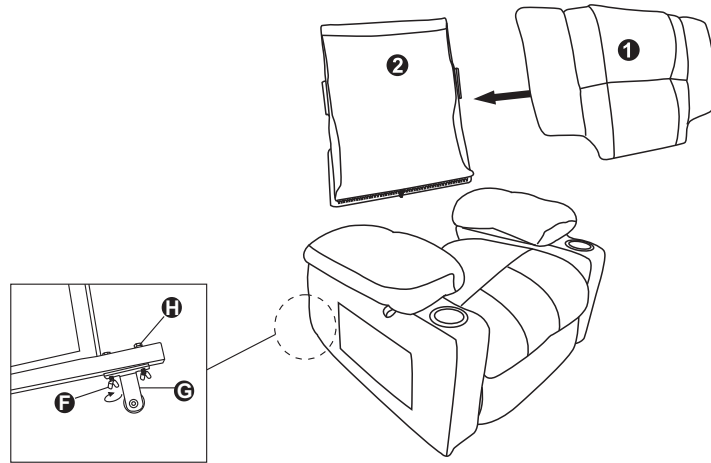

- 10.** Insert metal bolts of parts (both) to the backrest. Ensure they are put correctly.

- 9.** Insert backrest metal bolts to the seat as shown below. Ensure it is correctly in place.

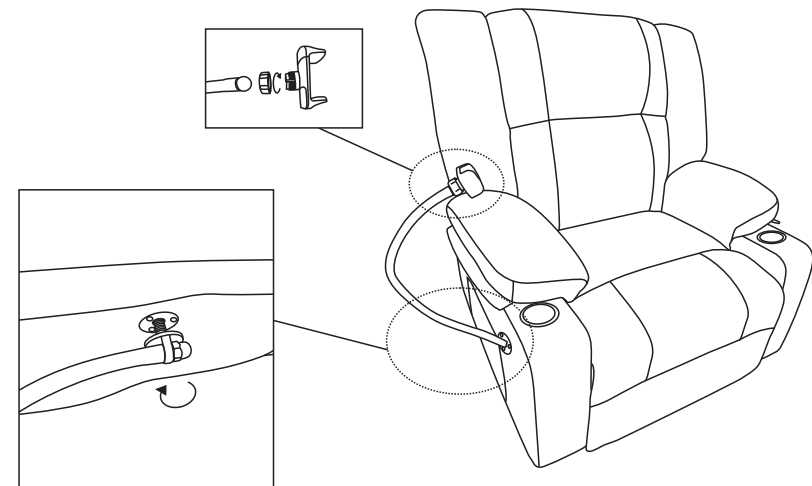
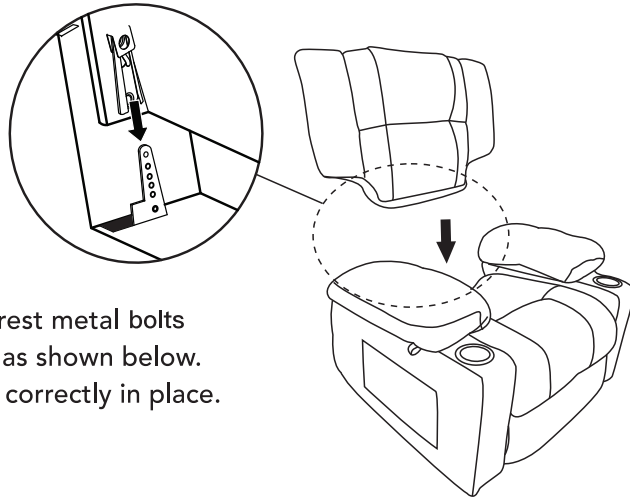

- 11.** Straighten the Cell Phone Stand (Part 7), lock it into the side nut of the handrail and lock it tightly.

12. Connect the cables.

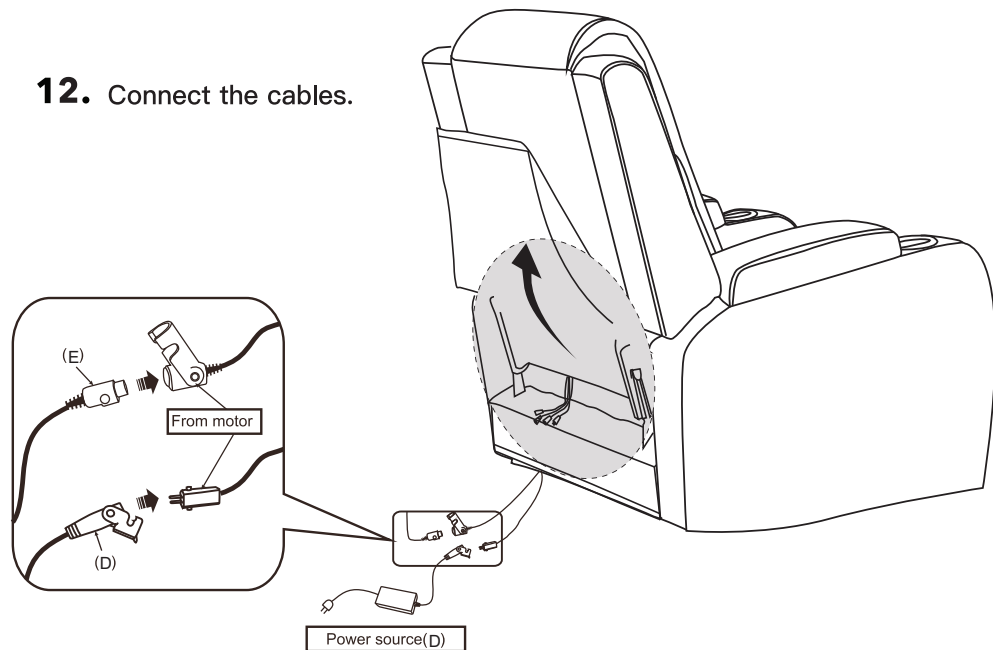

The method of connecting the power cords.

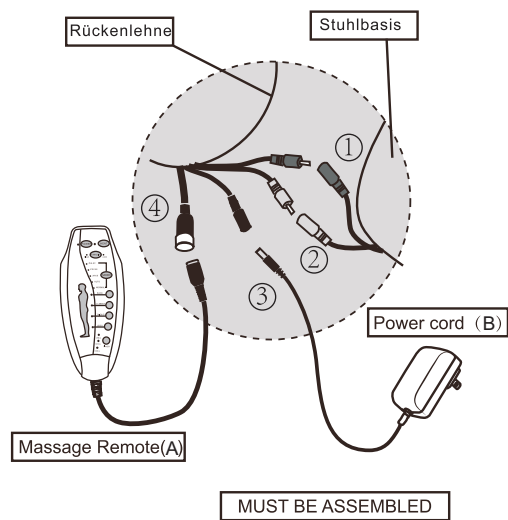

Connect ①② with wires of same color from the seat base.

Connect ③ with Power ③

Connect ④ with Remote control ④

RECLINE & FOOTREST OPERATING

A. How to recline

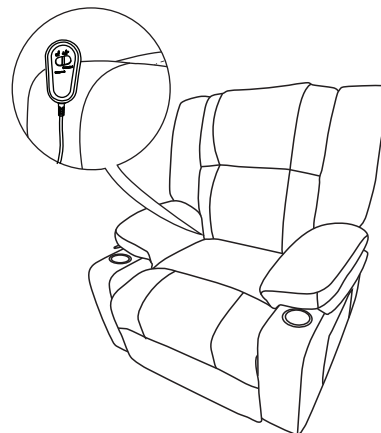

1. Lift

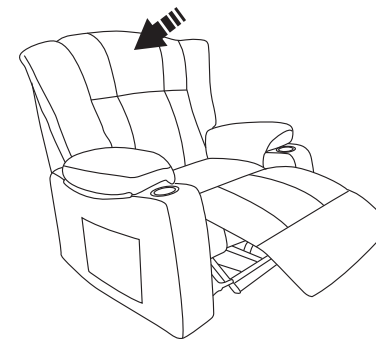

2. Recline

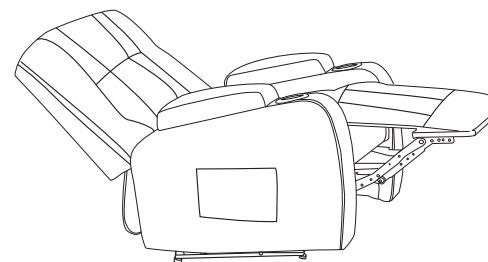

B. How to get footrest pushed down?

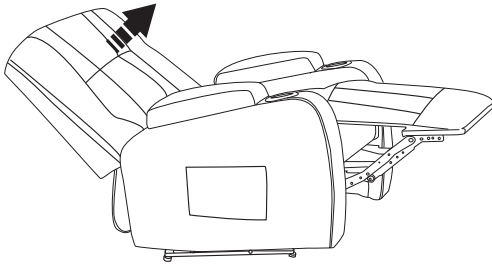

1. The backrest will return to the upright position by moving forward.

Accompany the footrest to the initial position by putting pressure with your legs.

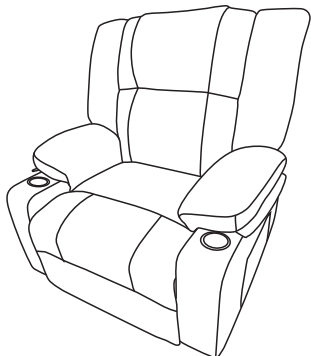
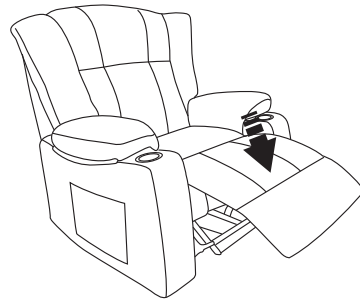

3. The recliner returns to the upright position.

C. Massage operation

INTENSITY: Change intensity (HIGH or LOW) during all modes.

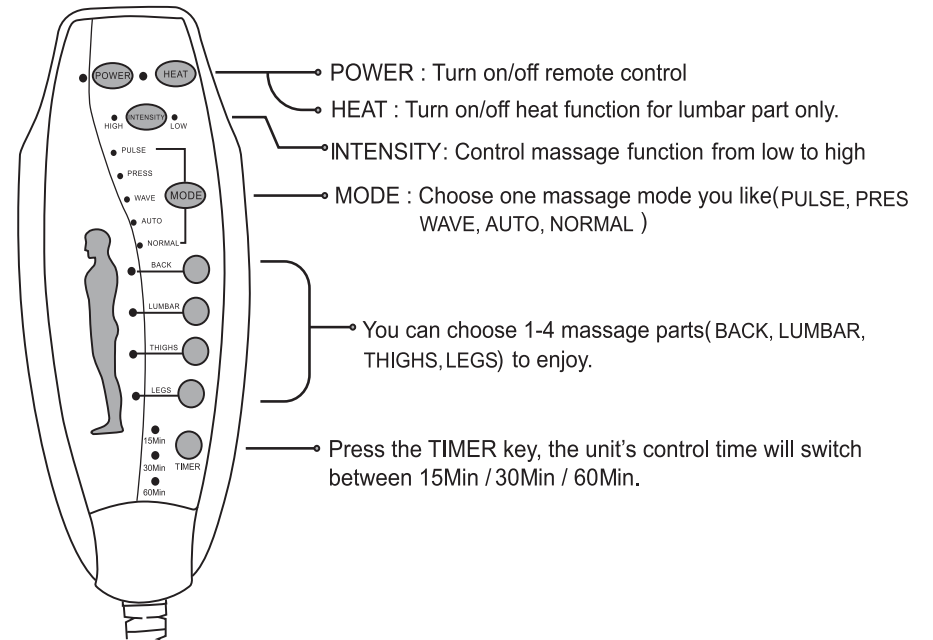

We recommend that the unit be used only for a few minutes initially, to allow your body to get used to the massage sensation. Gradually increase the length of time you use the massage function, over the first few periods of use. Should you experience any adverse reactions, stop using immediately and consult your medical practitioner.

USAGE

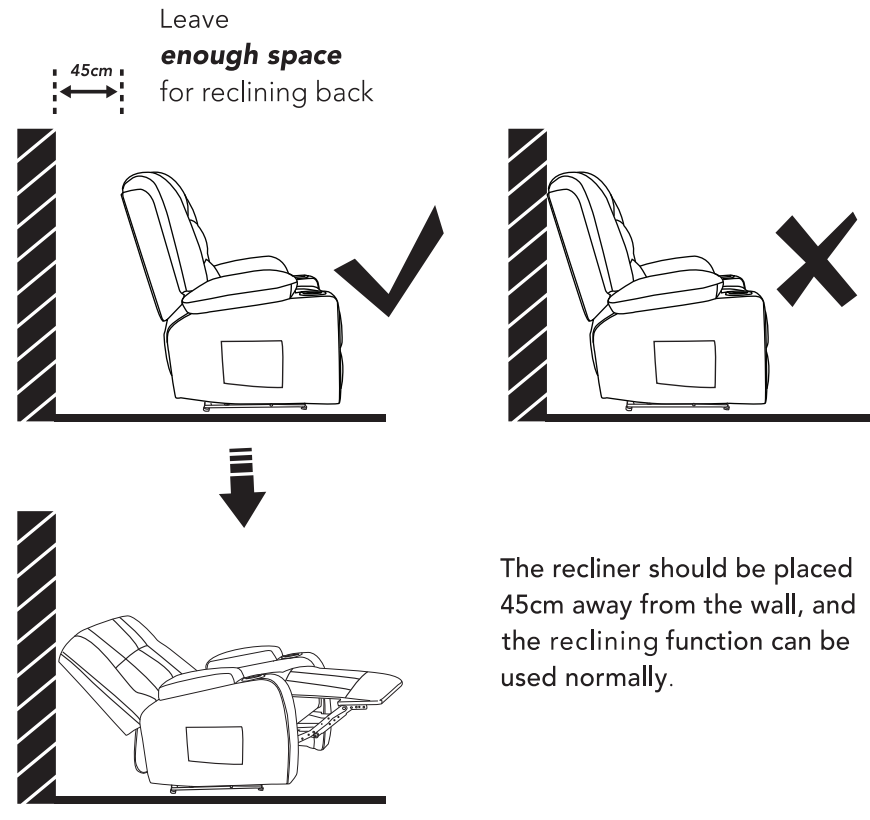

PROPER USAGE

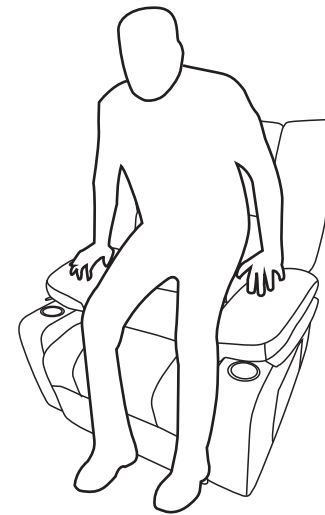

Steps to safely stand up from your Recliner Chair

1. Store the remote control **A** safely in the seat's side pocket
2. Plant feet firmly on the ground
3. Evenly distribute weight on both arms of the chair
4. Slowly stand up from upright position

* Remember to store remote control safely in the seat's side pocket when it is not in use.

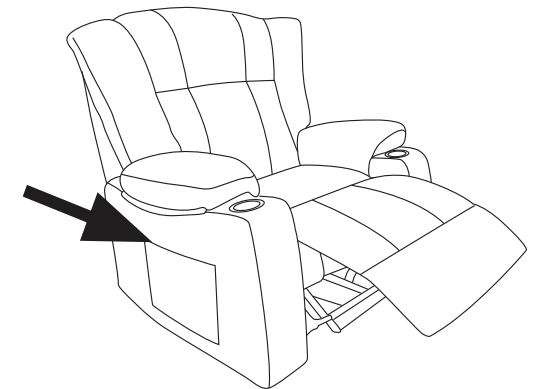

*Fabric will fade or discolor in direct sunlight. Minimize exposure to direct sunlight to extend the life of your furniture.

IMPROPER USAGE



DO NOT stand up when the footrest is in the upright position.

DO NOT stand up from your recliner chair with uneven weight.

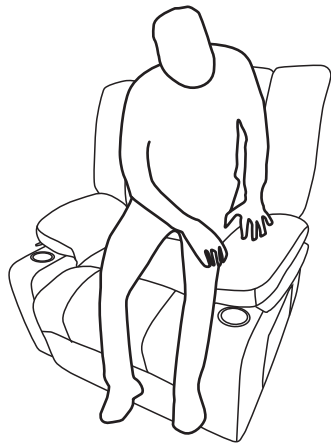
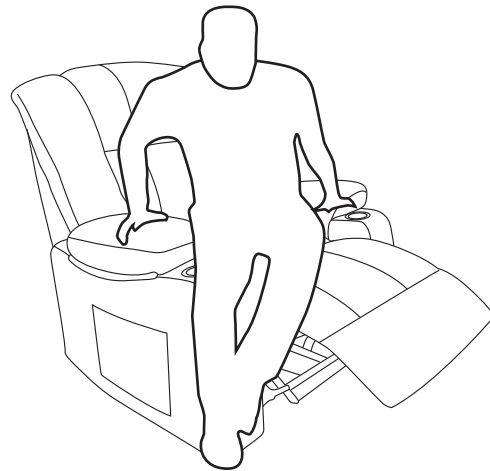

DO NOT stand up from your Recliner chair with only one arm.

As all action products contain moving parts, handle all items with care.

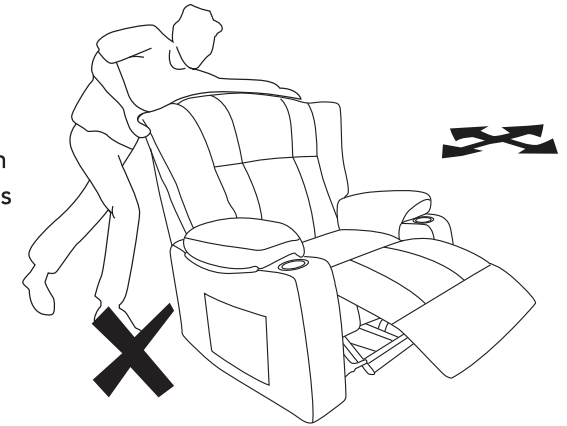

* Only move the recliner when it is in the 'upright' or 'closed' position. Never attempt to move the recliner when it is in any of the reclining positions. Always use the arms to move the Recliner-DO NOT use the backrest or backrest ear parts.

WARRANTY

So glad you have completed the assembly and can enjoy it. If you are satisfied with our products, thank you for showing your favored massage recliner to your around.

Our products come with a 2-month warranty, you can feel free to contact us at any time.

Methods :

If you choose Amazon, going to your Amazon order detail page, Order>sold by>contact seller
(guaranteed response within 24 hours)

AFTER-SALE POLICY

1. For return reason:

Wrong purchase, bought by mistake, no longer needed, doesn't meet expectation, a size smaller than expectation, customer need to cover the return shipping fee.

2. For cancel order:

Customer needs to pay for shipping fee and carrier handle fee if the item has been shipped out.

For change address: customer needs to pay for extra shipping fee and carrier handle fee if the item has been shipped out.

3. Customer Service:

Any problem with the product or shipping issue, please feel free to contact us, we will try our best to serve and help.