

ASSEMBLY INSTRUCTION

WF310613
WF310615

WF310614

Friendly Reminder:

- 1.This sofa is packed in 3 boxes. Please assemble it After all boxes are received.
- 2.As the cushions are all vacuum compressed,there will be some wrinkles.Please give your cushions up to 72 hours to reach its original size and the wrinkles will basically disappear.
- 3.Please do not open the compressed packags until your sofa frame is completely assembled.

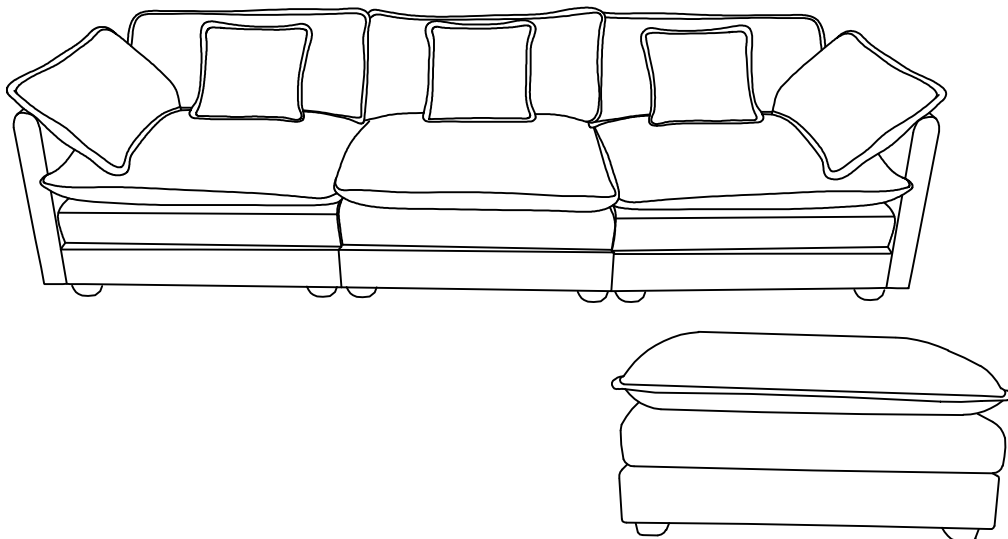





Return & Warranty policy:

- We strive to offer the highest quality products,and we also try our best to satisfy each and every customer that orders from us with replacement parts or service as needed.
- If the item is damaged or defective, please take photos as evidence for replacements and refunds.
- Please do not return to store,contact the seller if you have any troubles with this product.



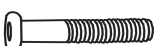

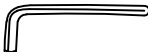

ASSEMBLY INSTRUCTION

HARDWARE

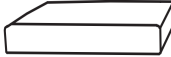

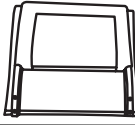

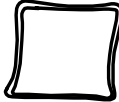

NO	DESCRIPTION	SKETCH	QTY
1	Washer		32
2	Gasket		16
3	Screws 8X60		20
4	Screws 8X80		6
5	Butterfly nut		6
6	Wrench		1

ASSEMBLY INSTRUCTION

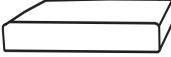
PARTS LIST WF310613

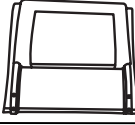



NO	DESCRIPTION	SKETCH	QTY
A	Seat frame		2
B	Seat cushion		2
E	Back frame		2
F	Back cushion		2
G	Pillow		2
J	Leg		8

PARTS LIST WF310614

NO	DESCRIPTION	SKETCH	QTY
A	Seat frame		1
B	Seat cushion		1
E	Back frame		1
F	Back cushion		1
G	Pillow		1
J	Leg		4

ASSEMBLY INSTRUCTION

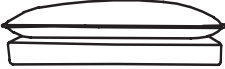
PARTS LIST WF310615

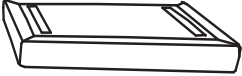
NO	DESCRIPTION	SKETCH	QTY
C	Left Armrest		1
D	Right Armrest		1
H	Arm Pillow		2
I	Ottoman cushion		1
J	Leg		4
K	Ottoman frame		1

ASSEMBLY INSTRUCTION

All parts and hardware.

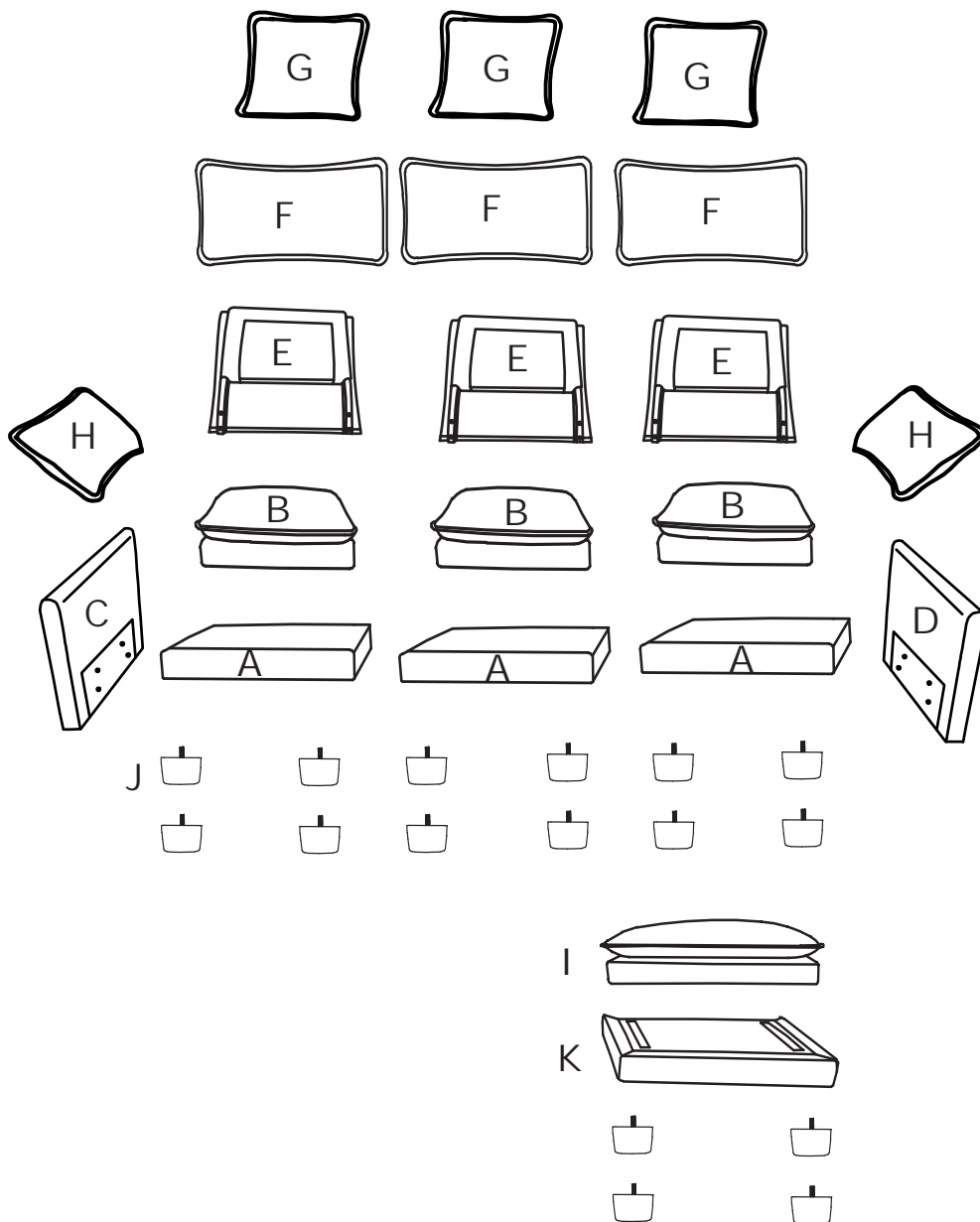

DIAGRAM 1 (Take out Back cushion and Arm Pillow)

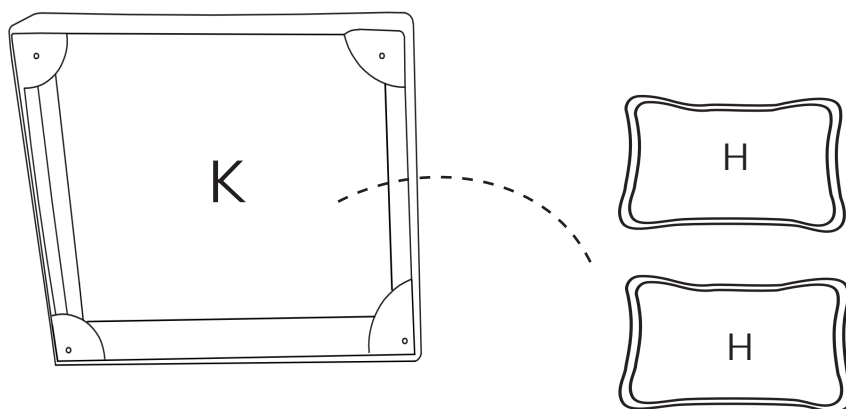
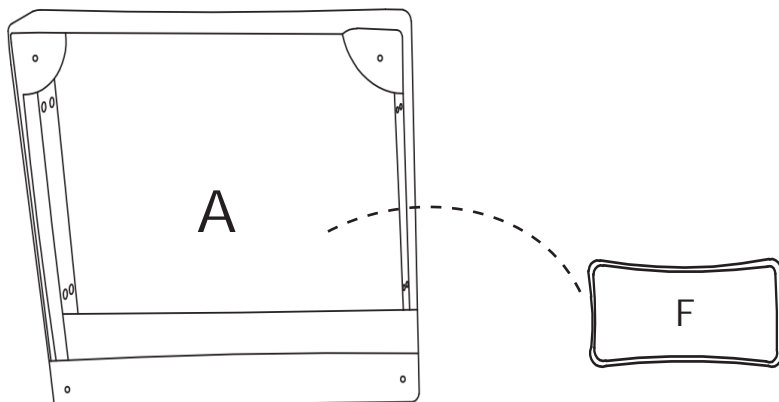
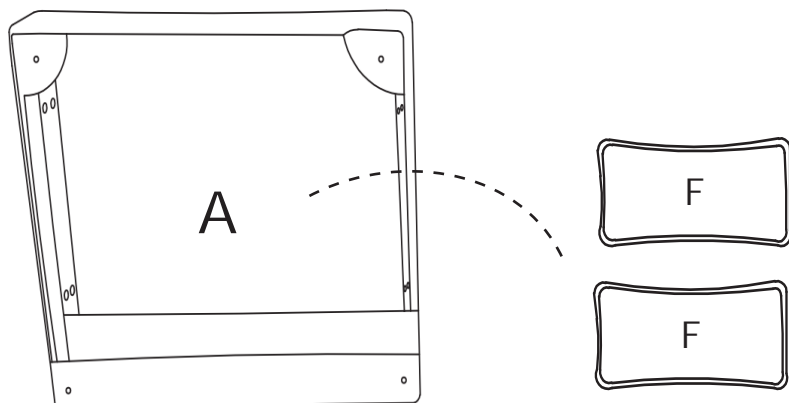



DIAGRAM 2 (Assemble th Armrest (left))

Assemble the Left Armrest(Part C) to the Seat Frame(Part A) with Washers(Hardware 1) and Screws(Hardware 3).

1		4PCS
3	 M8X60	4PCS

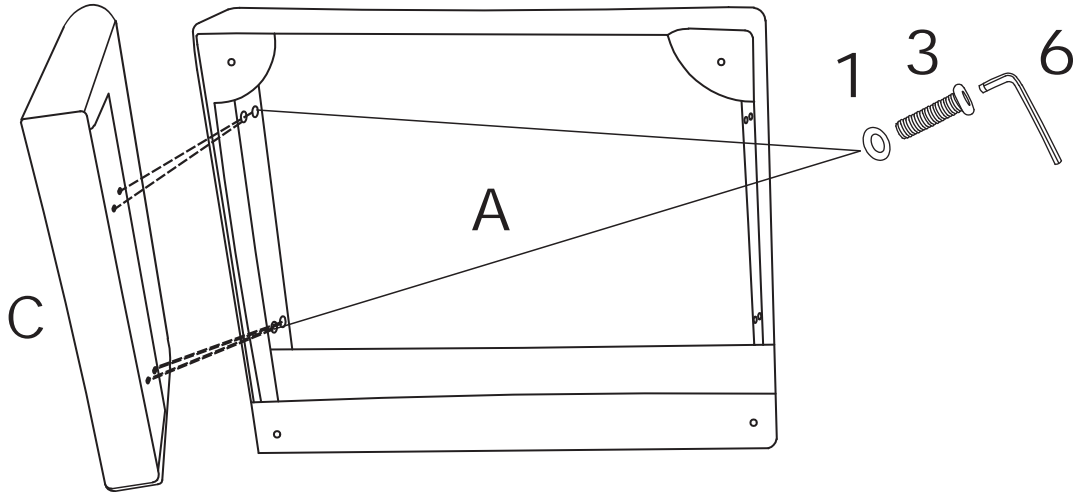



DIAGRAM 3 (Assemble the Armrest (right))

Assemble the Right Armrest(Part D) to the Seat Frame(Part A) with Washers(Hardware 1) and Screws(Hardware 3).

1		4PCS
3	 M8X60	4PCS

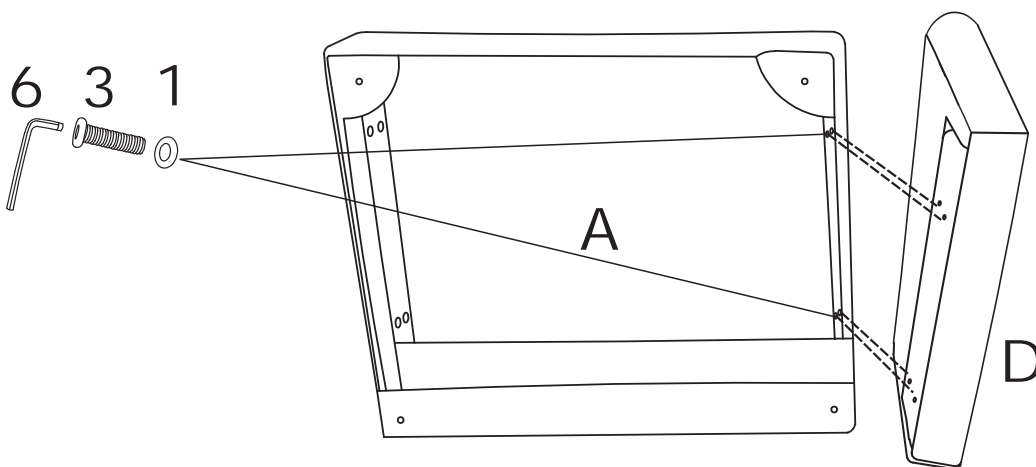





DIAGRAM 4 (Assemble the Seat frame)

Assemble Seat Frame(Part A) and Seat Frame(Part A) with Butterfly Nuts(Hardware 5) Washers(Hardware 1) and Screws(Hardware 4).

1		8PCS
4	 M8X80	4PCS
5		4PCS

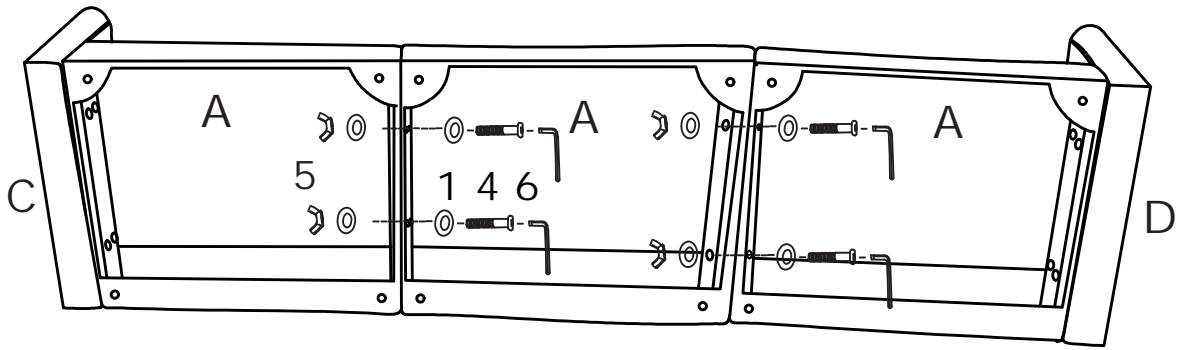

DIAGRAM 5 (Assemble the Leg)

Assemble the Legs(Part J) on the sofa with Gaskets(Hardware 2).

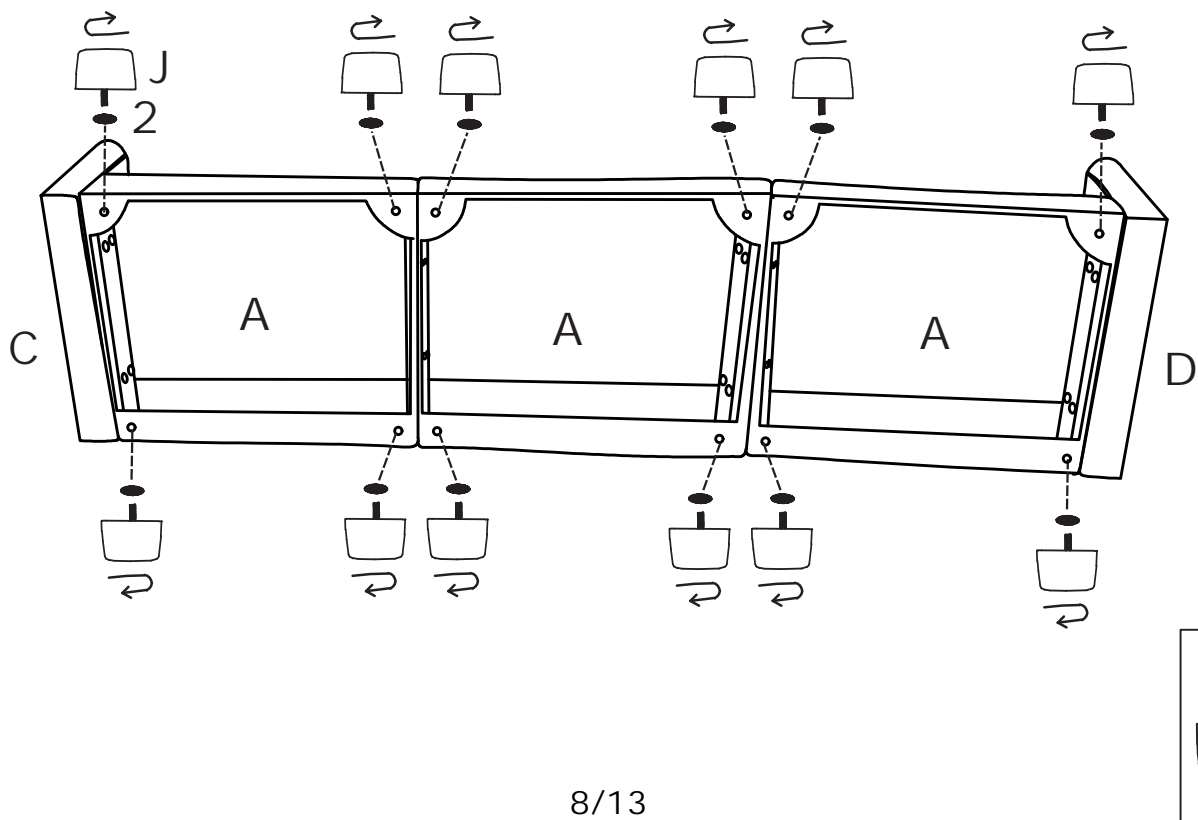

DIAGRAM 6 (Assemble the Leg)

Assemble the Legs(Part J) on the Ottoman frame with Gaskets(Hardware 2) .

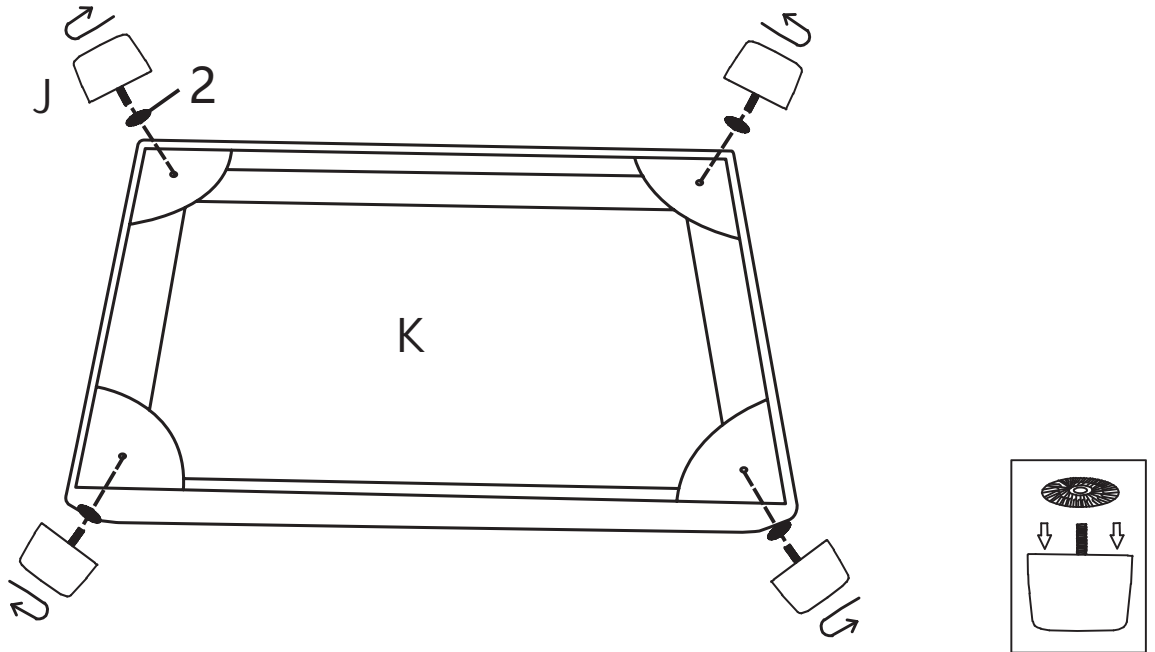



DIAGRAM 7 (Assemble the Back frame)

1		12PCS
3	 M8X60	12PCS

Insert the Back frame (Part E) into the designated holes,using Washers (Hardware 1)and Screws (Hardware 3) to 70% tightness,and then tighten the all Bolts on the seat.

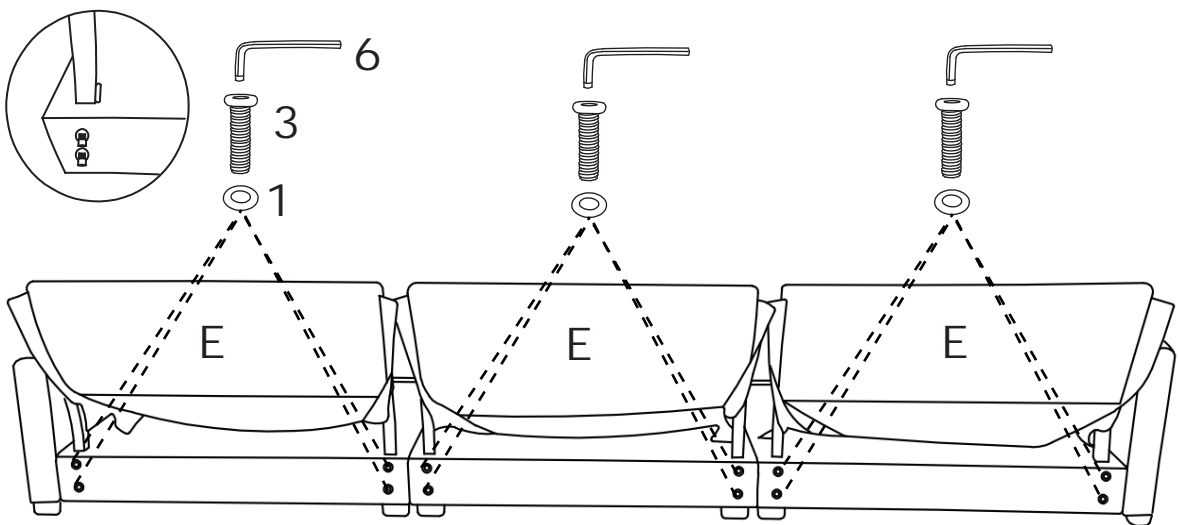

DIAGRAM 8

The cushions is packaged by vacuum compression. After cutting the package, it rebounds quickly within 4 hours. If the fabric has wrinkles, it will basically disappear after standing for 72 hours

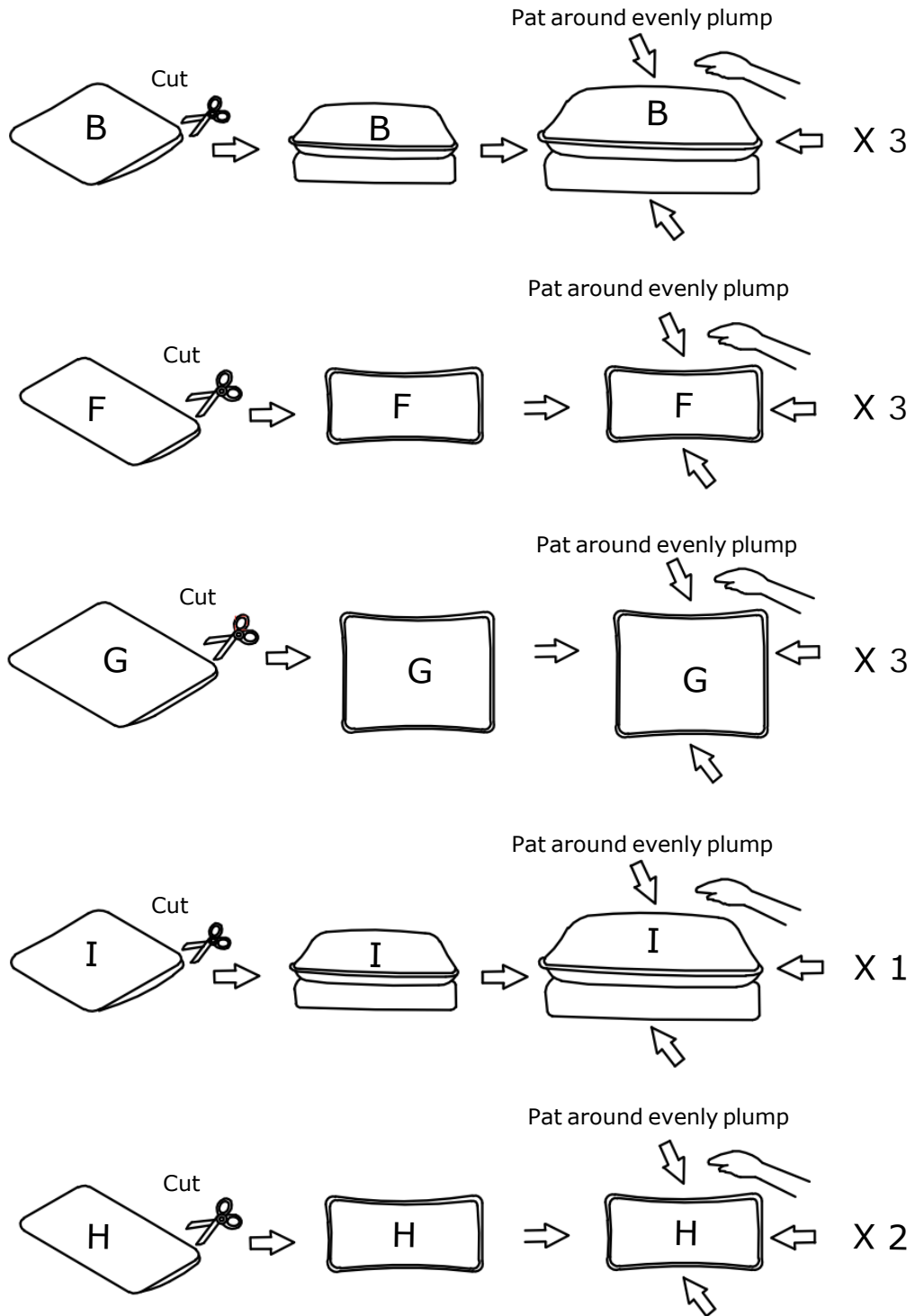

DIAGRAM 9 (Assemble the cushion)

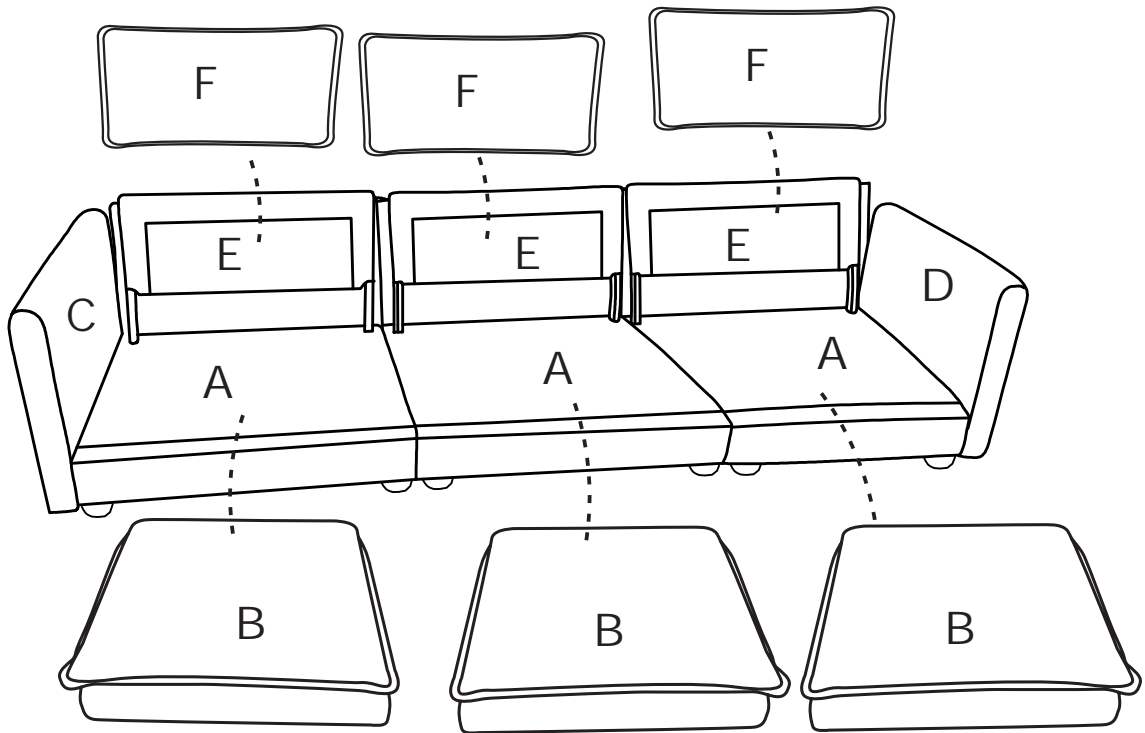

DIAGRAM 10 (Assemble the Pillow)

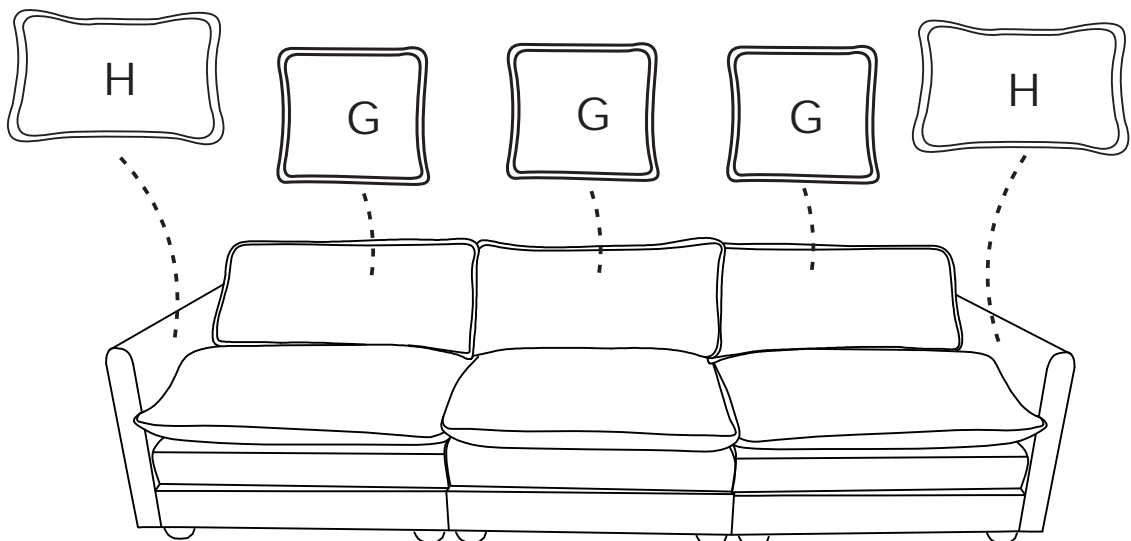

DIAGRAM 11(Assemble the Ottoman cushion)

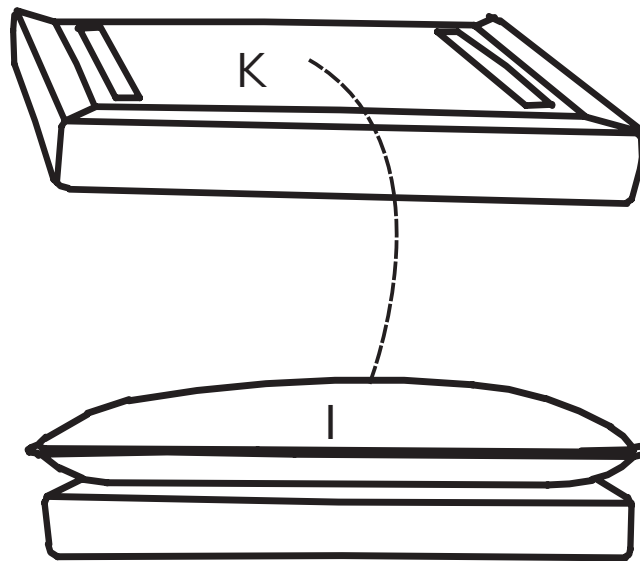
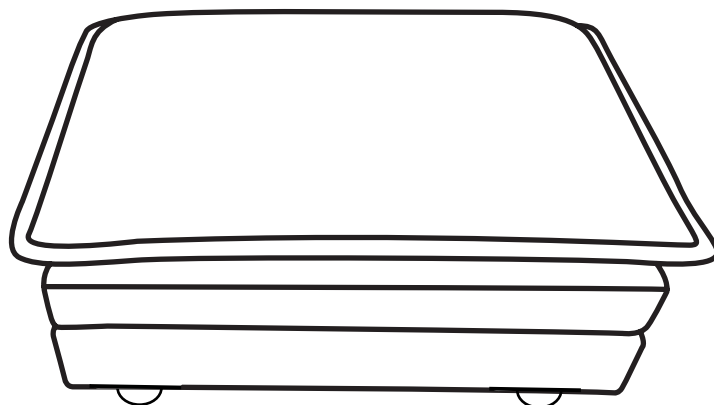

DIAGRAM 12

If the fabric has wrinkles, it will basically disappear after standing for 72 hours. Well done!! You can enjoy your leisure time on the sofa now.



TIPS:

1. Please do not open the compress packaging until your sofa frame is completely assembled.
2. Compress back cushions and pillows need to be fully fulfilled within 72 hours for your perfect use.
3. Please keep children away from plastic bags or any small pieces of stuff.

