

ASSEMBLY INSTRUCTIONS

ITEM NO: WF306319

DESCRIPTION: GLIDER MOTION RECLINER

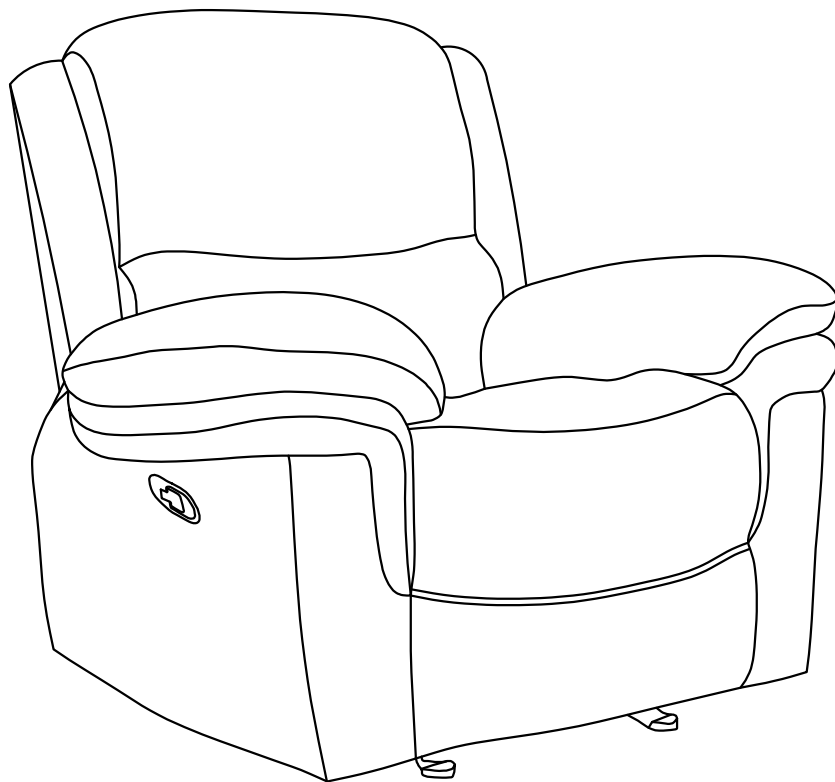

ASSEMBLY INSTRUCTIONS

ITEM NO: WF306319

DESCRIPTION: GLIDER MOTION RECLINER

PARTS AND HARDWARE

Avoid using sharp objects such as a knife to cut open packing as you may accidentally damage the upholstery

A * 1

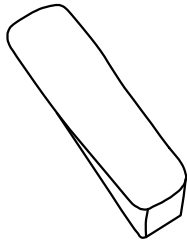

Left Wing

B * 1

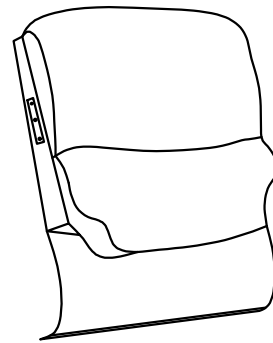

Back Cushion

C * 1

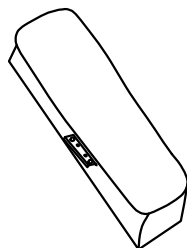

Right Wing

D * 1

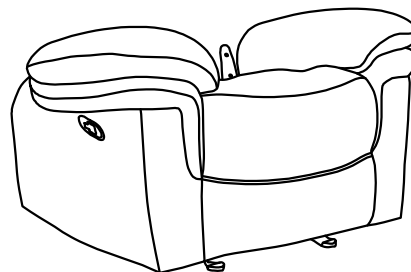

Seat

ASSEMBLY INSTRUCTIONS

ITEM NO: WF306319

DESCRIPTION: GLIDER MOTION RECLINER

CAUTION: At least two adults are required to safely complete performing this task. Other lifting attempts may risk back injury due to large and heavy part(s).

Step 1. Attach the Backrest to Seat Body
Ensure it is correctly in place

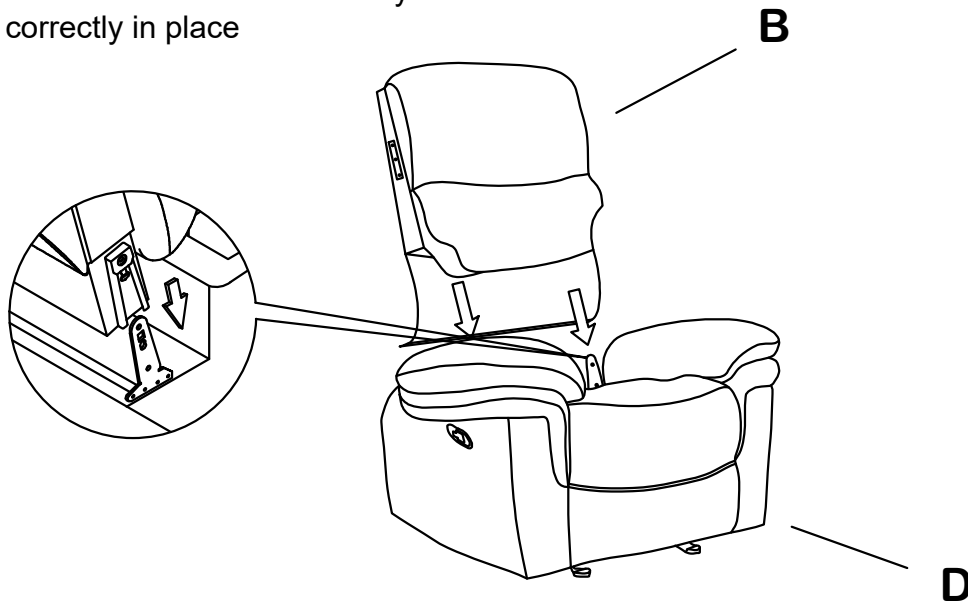

Step 2. Attach the Wing (Left/Right) to Backrest
Ensure it is correctly in place

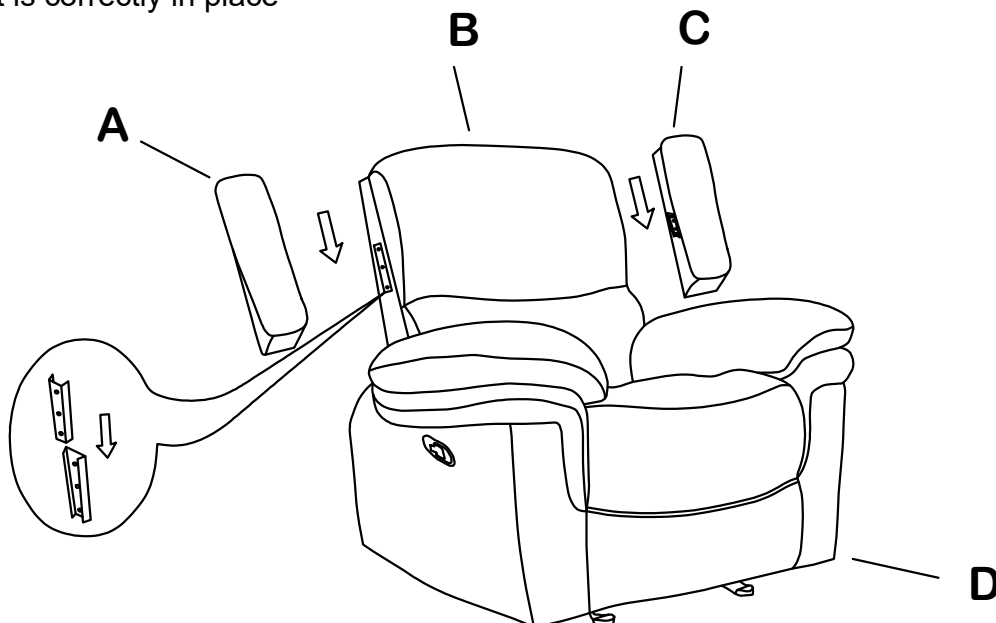

ASSEMBLY INSTRUCTIONS

ITEM NO: WF306319

DESCRIPTION: GLIDER MOTION RECLINER

CAUTION: At least two adults are required to safely complete performing this task. Other lifting attempts may risk back injury due to large and heavy part(s).

Step 3. Stretch and pull down rear cover evenly before securing velcro strip to seat base. Repeat if necessary for better fit

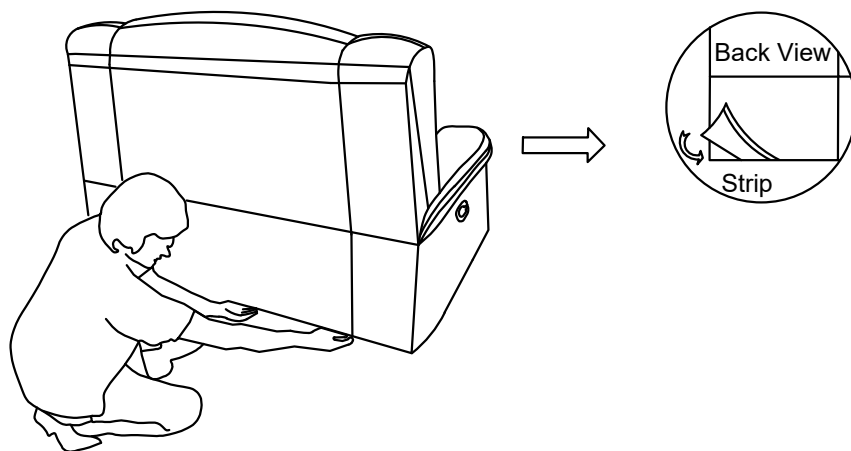

OPERATING YOUR UNIT

Converting to Footrest Position

-To raise or lower the legrest, push the power switch & hold. Release the switch when the legrest reaches the desired high

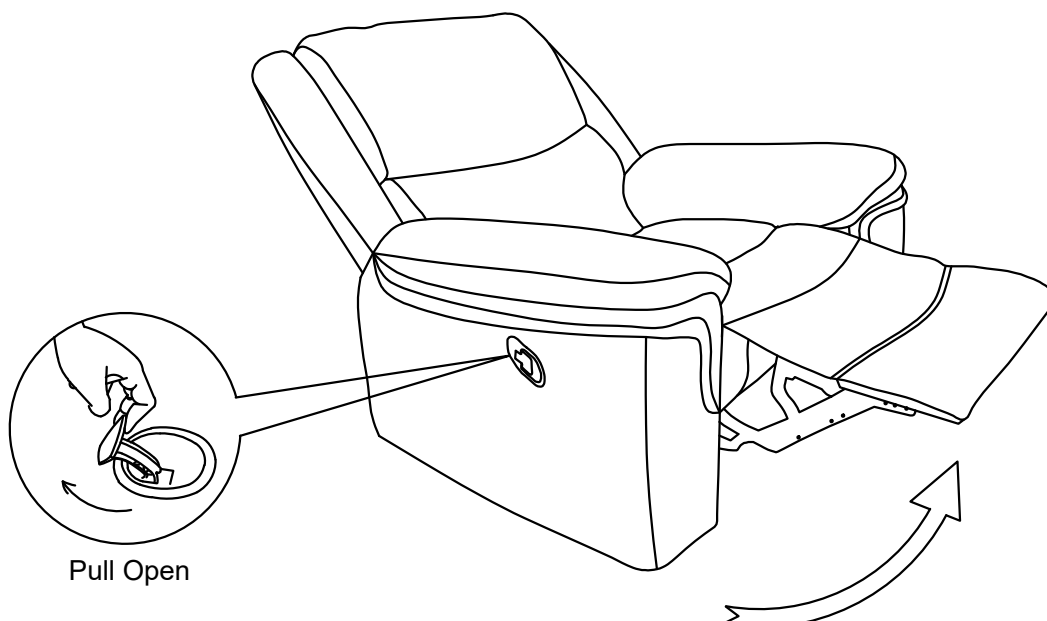

ASSEMBLY INSTRUCTIONS

ITEM NO: WF306320

**DESCRIPTION: Glider Motion Loveseat with
Console and Power strip**

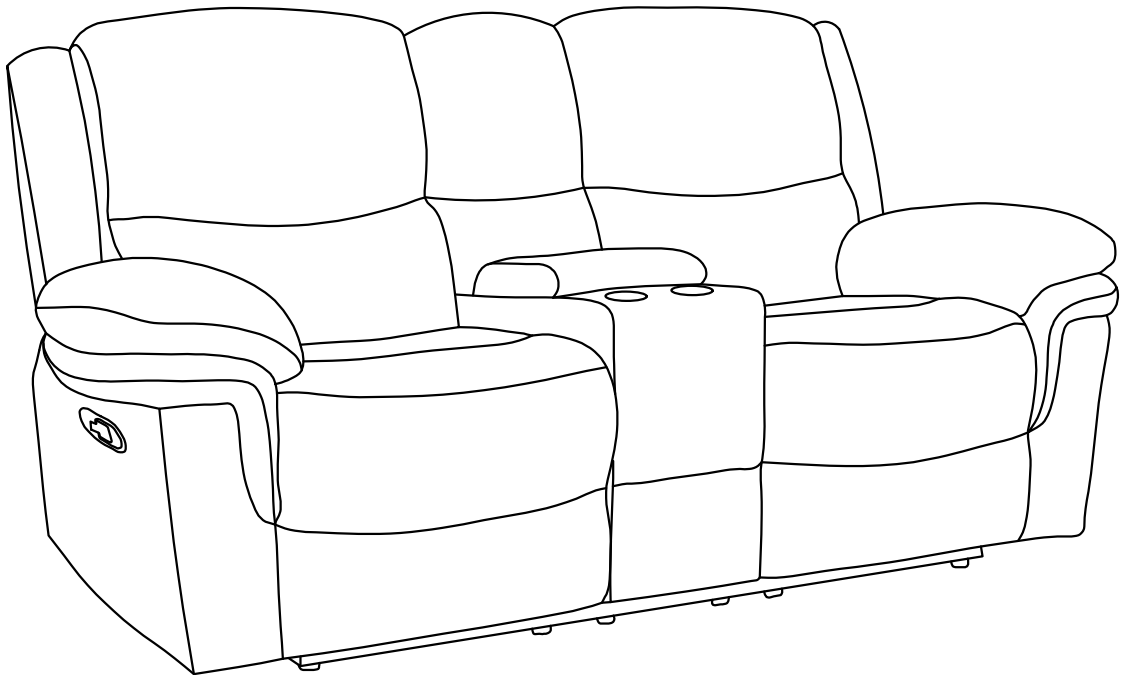

ASSEMBLY INSTRUCTIONS

ITEM NO: WF306320

DESCRIPTION: Glider Motion Loveseat with
Console and Power strip

PARTS AND HARDWARE

Avoid using sharp objects such as a knife to cut open packing as you may accidentally damage the upholstery

A * 1

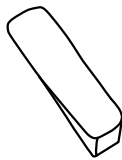

Left Wing

B * 1



Left Back Cushion

C * 1

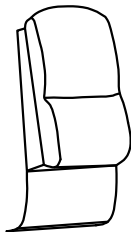

Console Back

D * 1



Right Back Cushion

E * 1

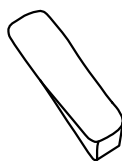

Right Wing

F * 1

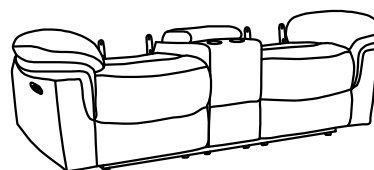

Seat

ASSEMBLY INSTRUCTIONS

ITEM NO: WF306320

DESCRIPTION: Glider Motion Loveseat with Console and Power strip

CAUTION: At least two adults are required to safely complete performing this task. Other lifting attempts may risk back injury due to large and heavy part(s).

Step 1. Attach the Backrest (Left/Right) and Backrest console to Seat Body
Ensure it is correctly in place

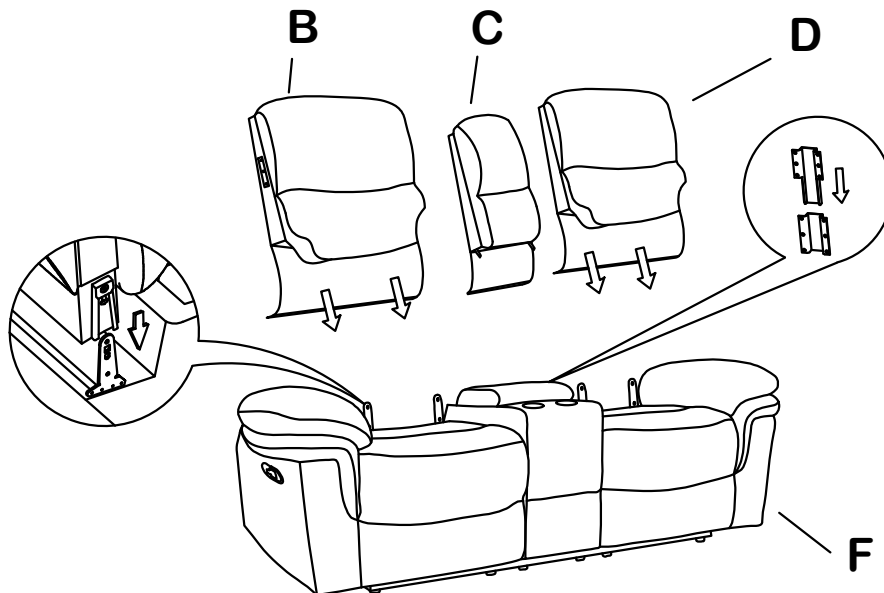

Step 2. Attach the Wing (Left/Right) to Backrest (Left/Right)
Ensure it is correctly in place

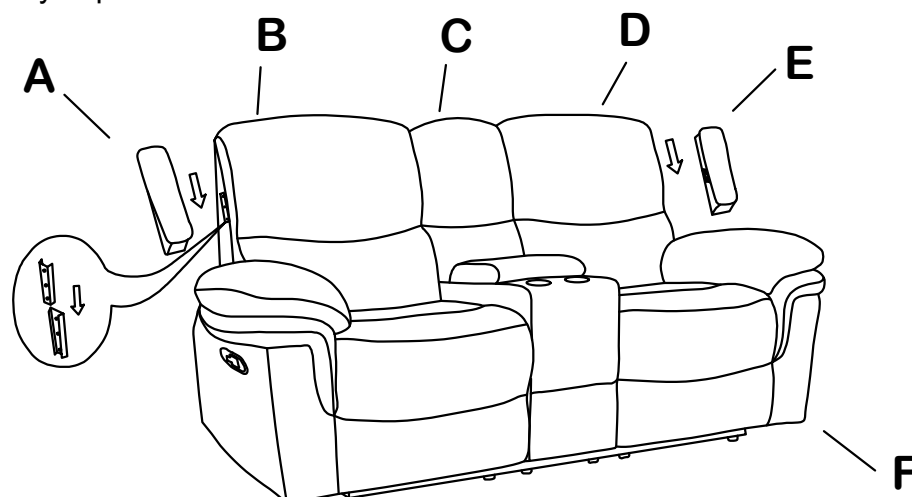

ASSEMBLY INSTRUCTIONS

ITEM NO: WF306320

**DESCRIPTION: Glider Motion Loveseat with
Console and Power strip**

CAUTION: At least two adults are required to safely complete performing this task. Other lifting attempts may risk back injury due to large and heavy part(s).

Step 3. Stretch and pull down rear cover evenly before securing velcro strip to seat base. Repeat if necessary for better fit

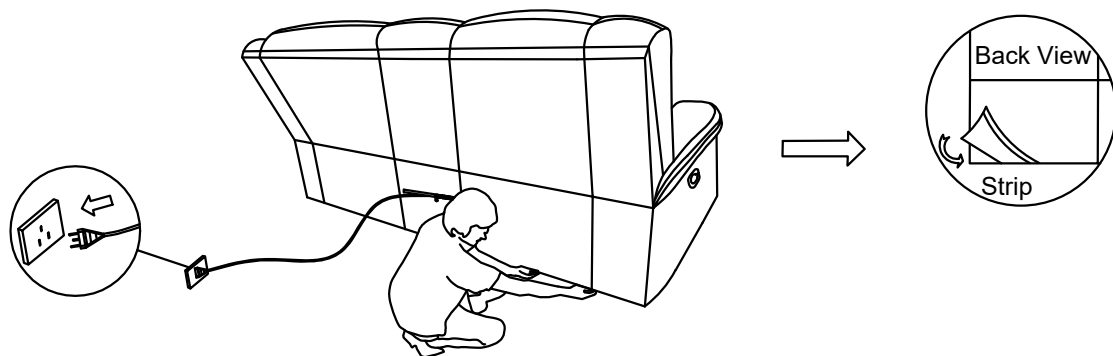

OPERATING YOUR UNIT

Converting to Footrest Position

-To raise or lower the legrest, push the power switch & hold. Release the switch when the legrest reaches the desired high

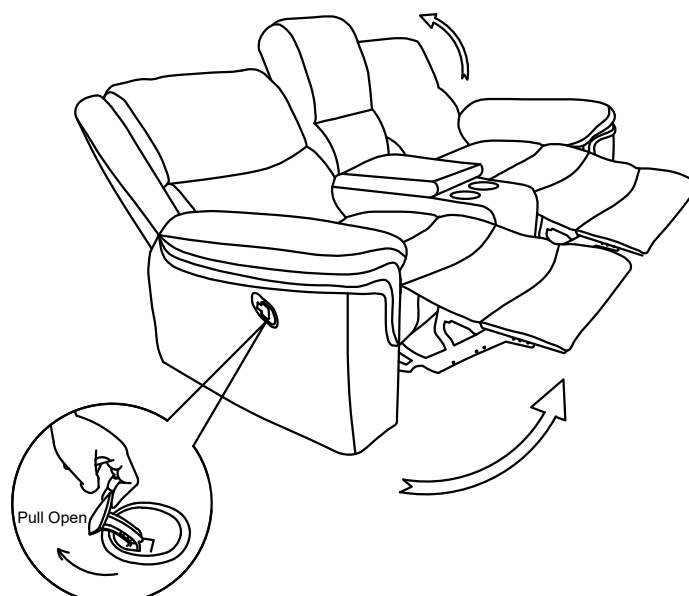

ASSEMBLY INSTRUCTIONS

ITEM NO: WF306321

DESCRIPTION: Motion Sofa with Dropdown
and Power strip

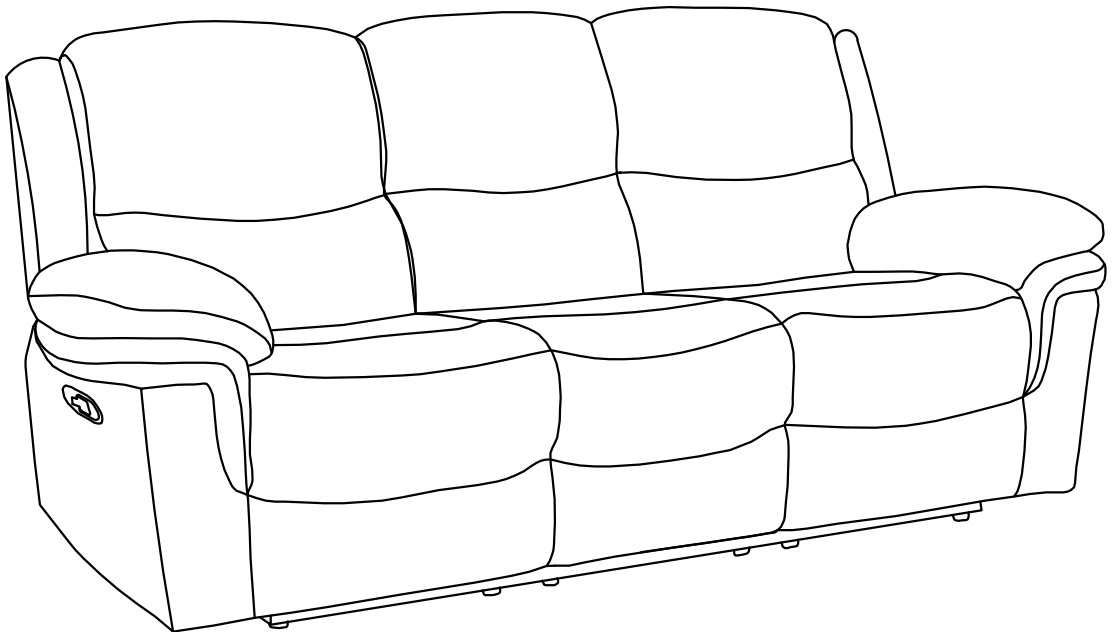

ASSEMBLY INSTRUCTIONS

ITEM NO: WF306321

**DESCRIPTION: Motion Sofa with Dropdown
and Power strip**

PARTS AND HARDWARE

Avoid using sharp objects such as a knife to cut open packing as you may accidentally damage the upholstery

A * 1

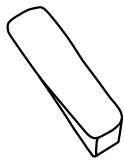

Left Wing

B * 1



Left Back Cushion

C * 1

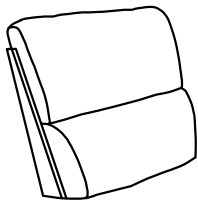

Mid Back

D * 1



Right Back Cushion

E * 1

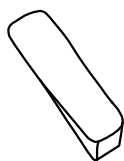

Right Wing

F * 1

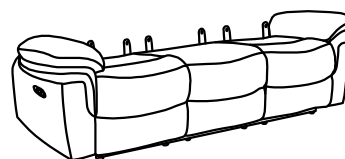

Seat

ASSEMBLY INSTRUCTIONS

ITEM NO: WF306321

**DESCRIPTION: Motion Sofa with Dropdown
and Power strip**

CAUTION: At least two adults are required to safely complete performing this task. Other lifting attempts may risk back injury due to large and heavy part(s).

Step 1. Attach the Backrest (Left/Mid/Right) to Seat Body
Ensure it is correctly in place

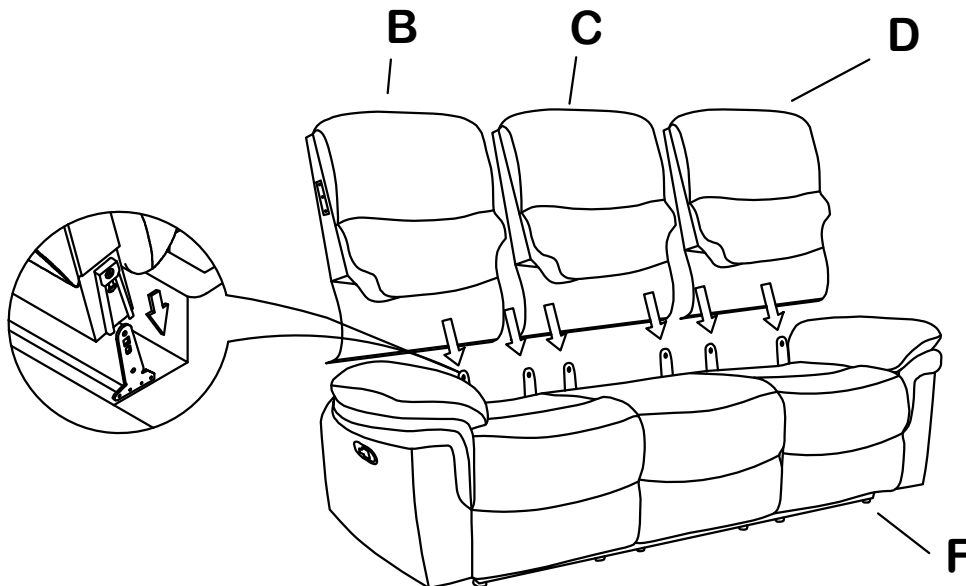

Step 2. Attach the Wing (Left/Right) to Backrest (Left/Right)
Ensure it is correctly in place

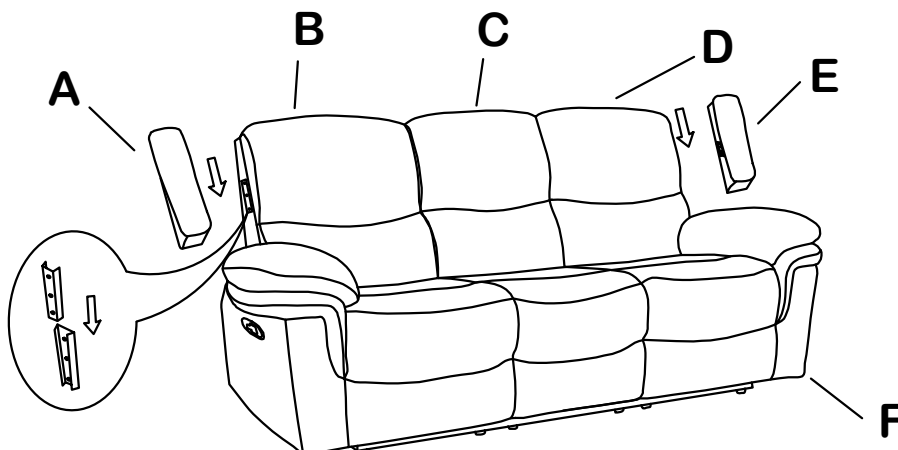

ASSEMBLY INSTRUCTIONS

ITEM NO: WF306321

**DESCRIPTION: Motion Sofa with Dropdown
and Power strip**

CAUTION: At least two adults are required to safely complete performing this task. Other lifting attempts may risk back injury due to large and heavy part(s).

Step 3. Stretch and pull down rear cover evenly before securing velcro strip to seat base. Repeat if necessary for better fit

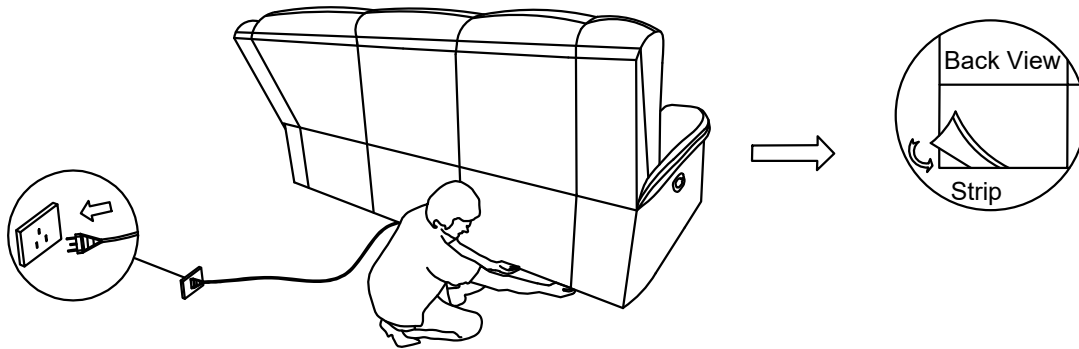

OPERATING YOUR UNIT

Converting to Footrest Position

-To raise or lower the legrest, push the power switch & hold. Release the switch when the legrest reaches the desired high

