

1

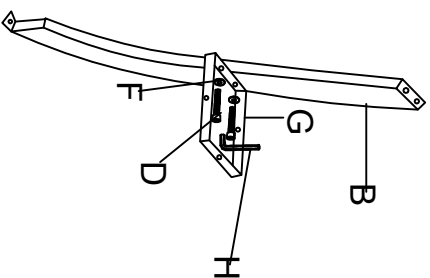

2

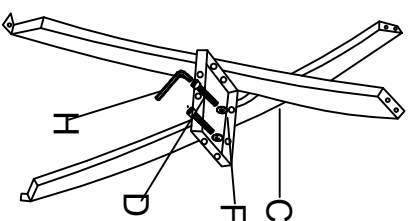

- D X2
- F X2

- D X2
- F X2

A

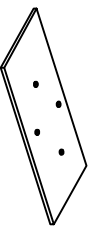

1X

B

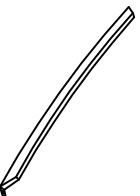

2X

C

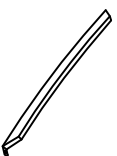

2X

D



12X

E



4X

F



12X

G

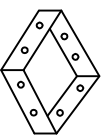

1X

H



1X

3

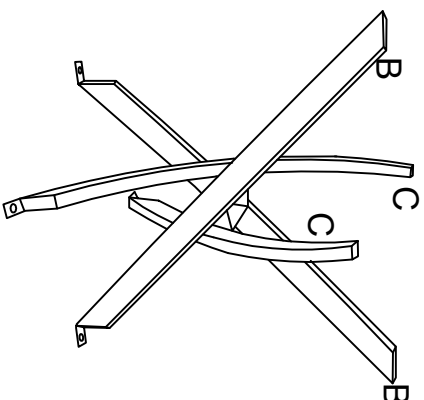

- D X4
- F X4

4

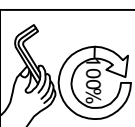
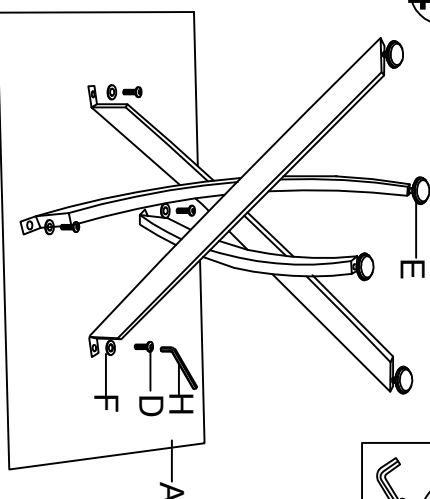

- E X4
- D X4
- F X4