

ASSEMBLY INSTRUCTIONS

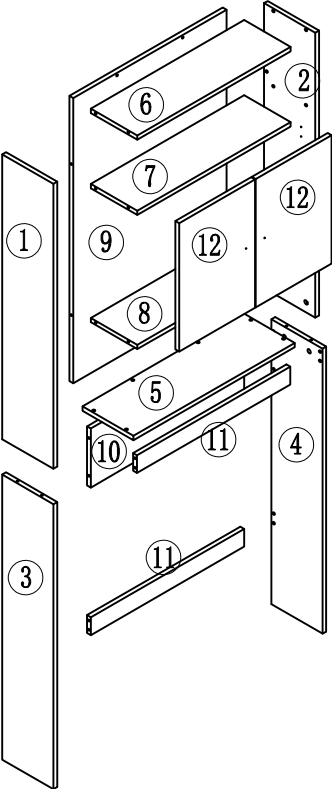

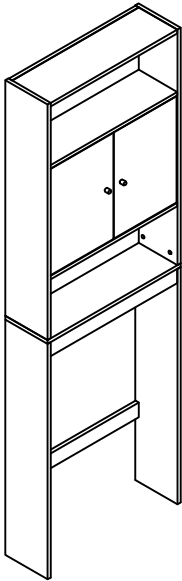

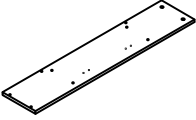

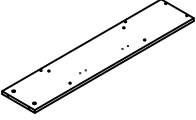
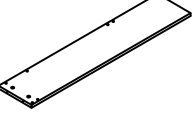
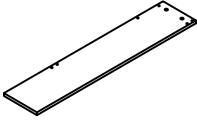
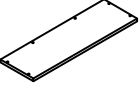
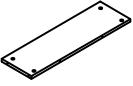
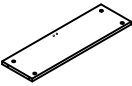
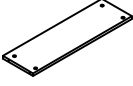
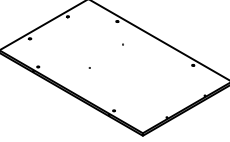
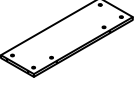
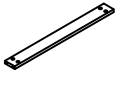
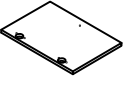

SKU: W37040389

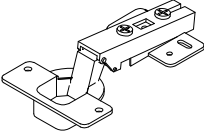
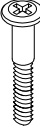

Part List

| | | | | |
|---|---|---|--|---|
|  |  |  |  |  |
| ① x1Pc | ② x1Pc | ③ x1Pc | ④ x1Pc | ⑤ x1Pc |
|  |  |  |  |  |
| ⑥ x1Pc | ⑦ x1Pc | ⑧ x1Pc | ⑨ x1Pc | ⑩ x1Pc |
|  |  | | | |
| ⑪ x2Pcs | ⑫ x2Pcs | | | |

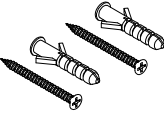
Hardware List

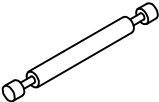
| | | | | |
|---|---|---|--|---|
|  |  |  |  |  |
| Ax36Pcs | Bx40Pcs | Cx26Pcs | Dx4Pcs | Ex2Pcs |
|  |  |  |  |  |
| Fx1Pc | Gx2Pcs | Hx2Pcs | Kx2Pcs | Lx1Pc |
|  | | | | |
| Mx2Pcs | | | | |

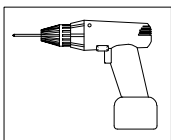

PLEASE BE CAREFUL. DO NOT DAMAGE THE HOLE POSITION WHEN YOU USE POWER TOOLS !

Step 1

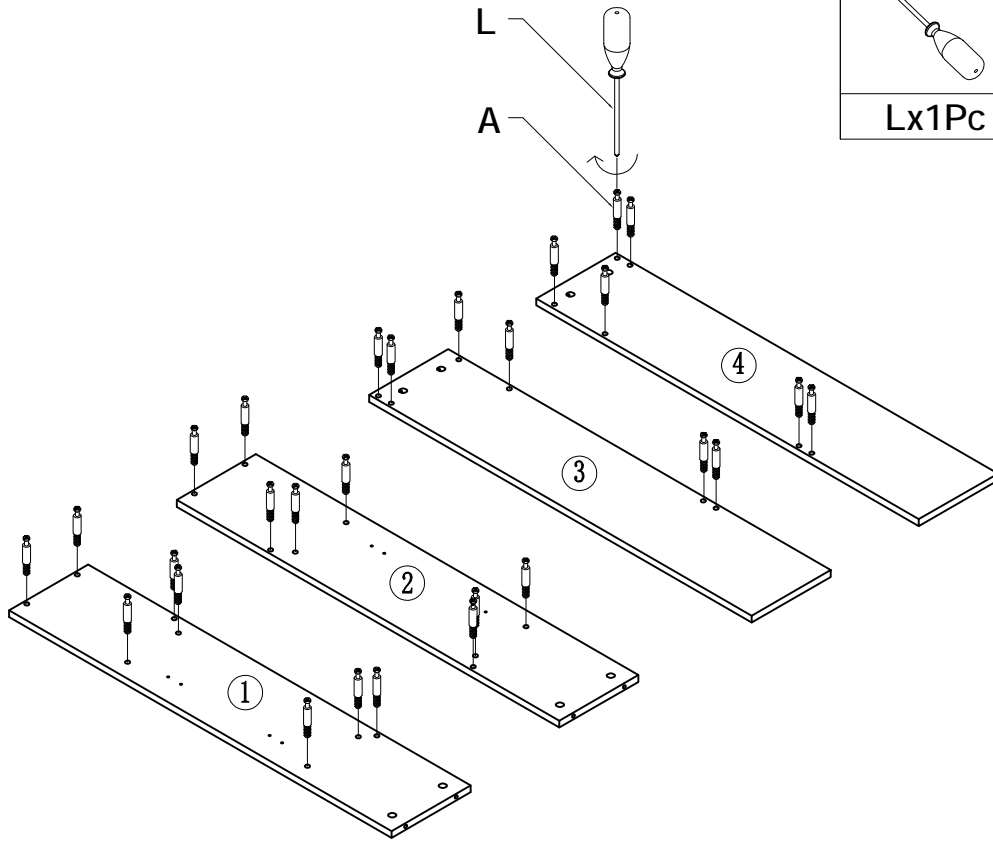

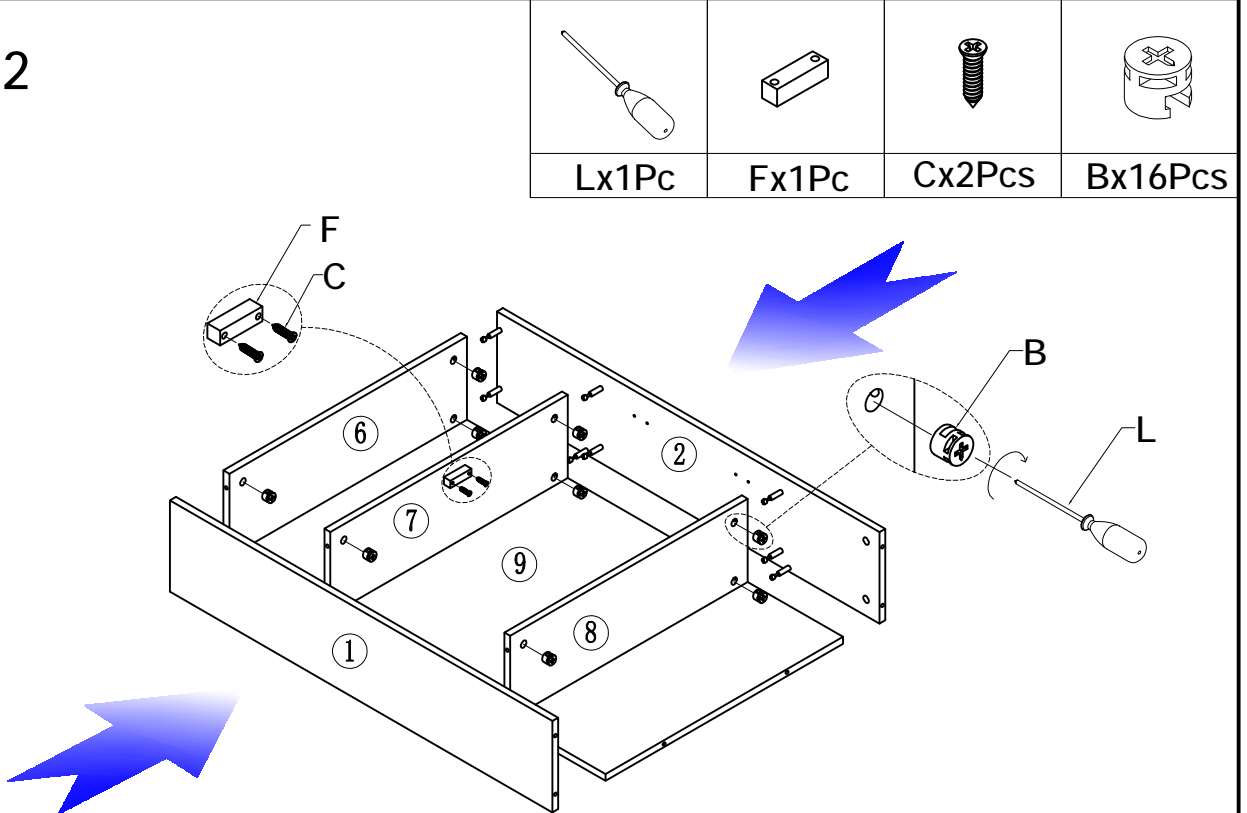

Step 2



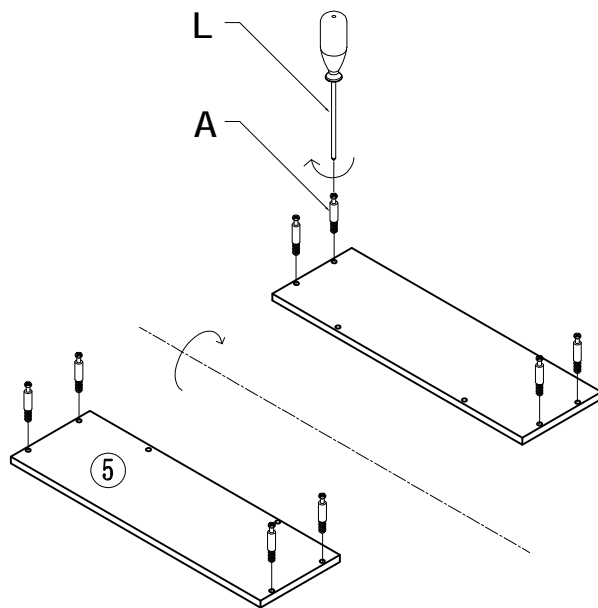

Step 3



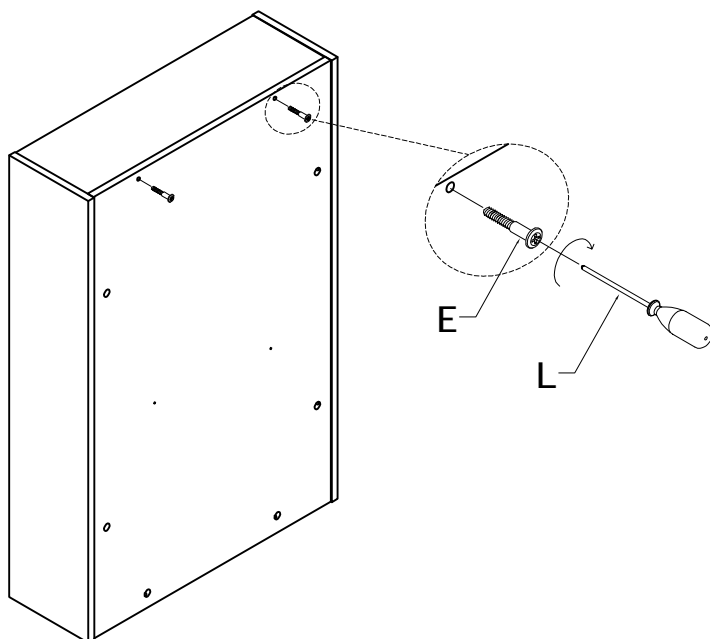

| | |
|---|---|
|  |  |
| Lx1Pc | Ax8Pcs |

Step 4

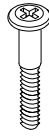



| | |
|---|---|
|  |  |
| Lx1Pc | Ex2Pcs |

Step 5

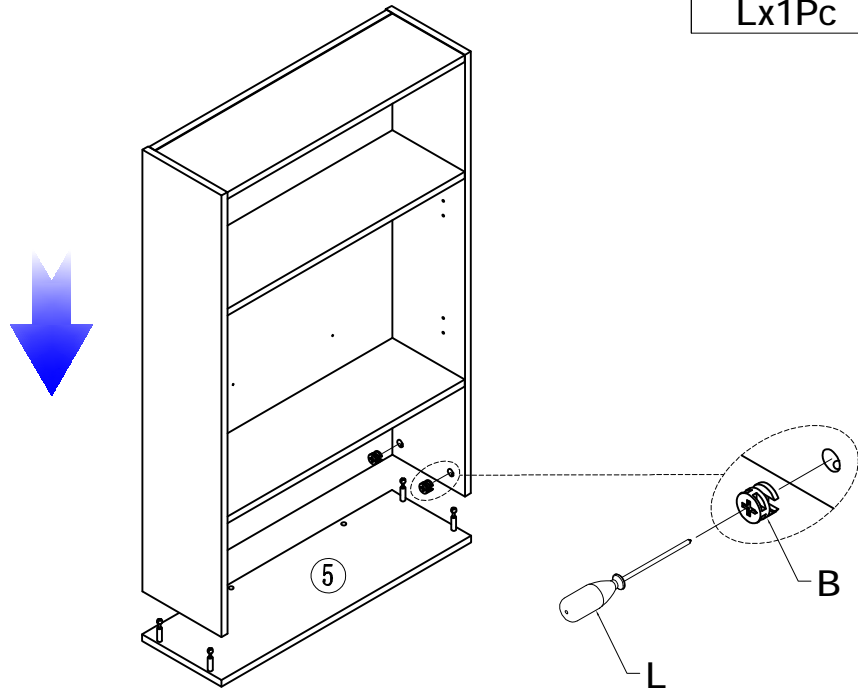
| | |
|---|---|
|  |  |
| Lx1Pc | Bx4Pcs |



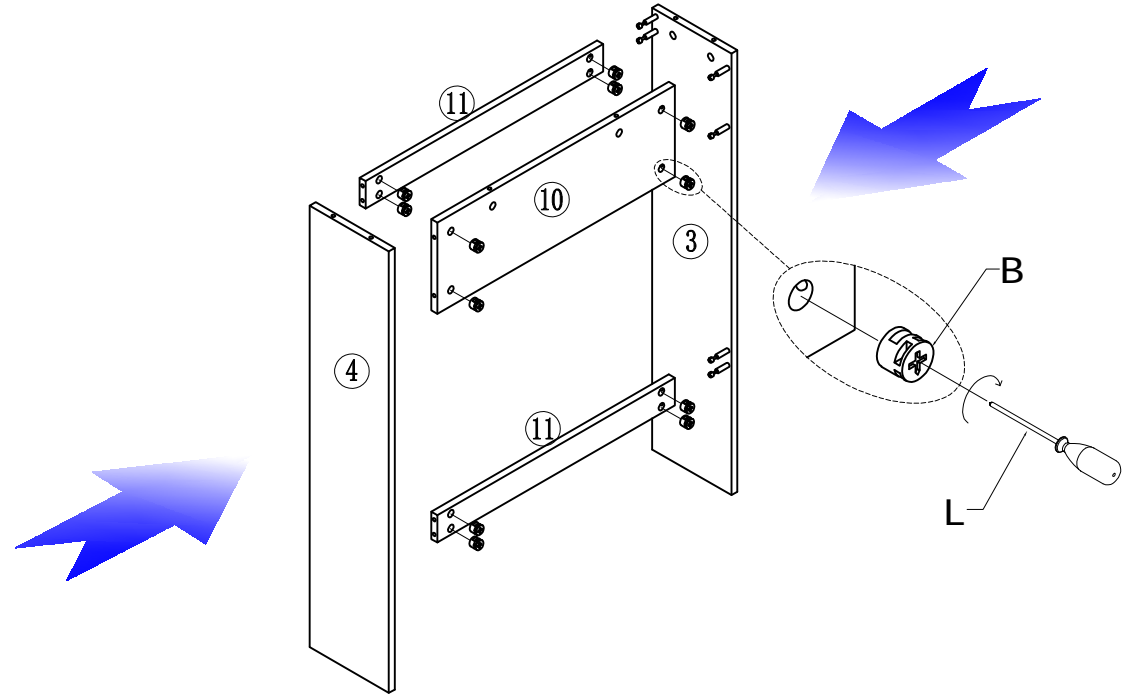

Step 6

| | |
|---|---|
|  |  |
| Lx1Pc | Bx12Pcs |



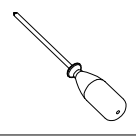
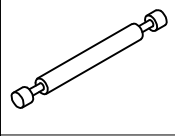

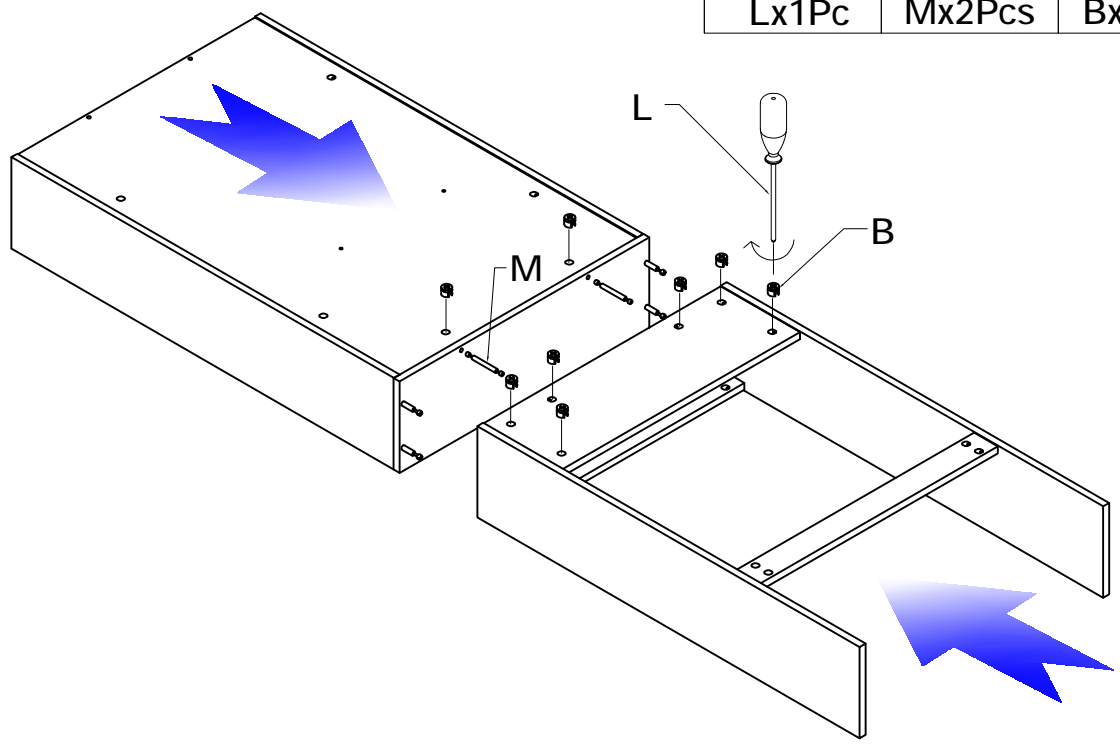

Step 7

| | | |
|--|---|---|
|  |  |  |
| Lx1Pc | Mx2Pcs | Bx8Pcs |



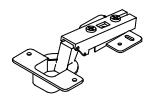

Step 8

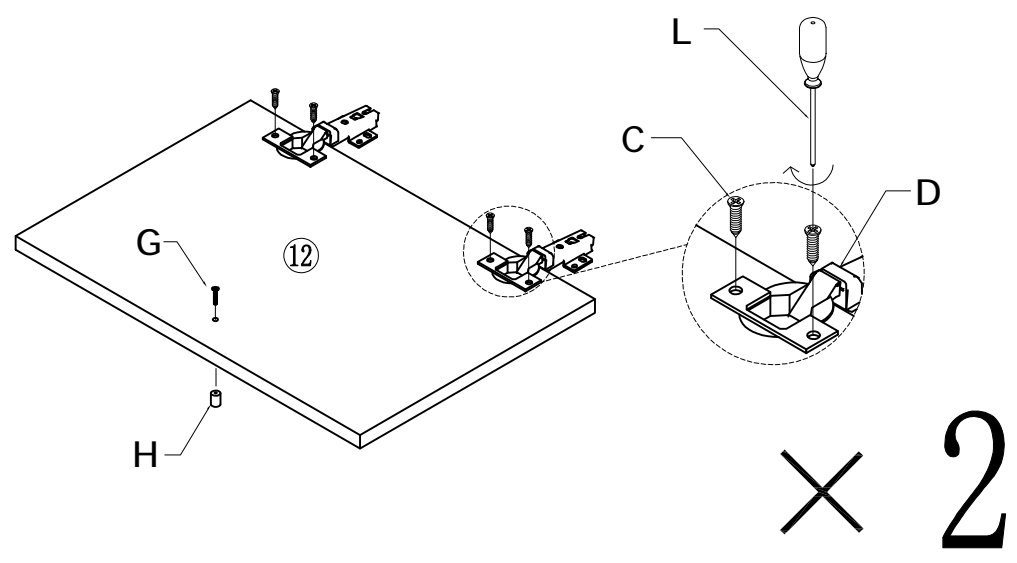
| | | | | |
|---|---|---|---|---|
|  |  |  |  |  |
| Lx1Pc | Hx2Pcs | Gx2Pcs | Dx4Pcs | Cx8Pcs |



Step 9

| | |
|---|---|
|  |  |
| Lx1Pc | Cx16Pcs |

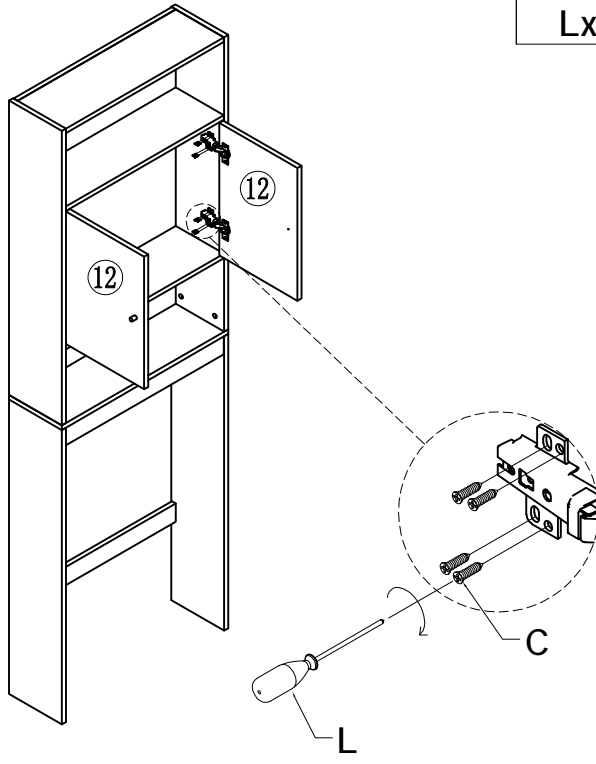

Step 10

| |
|---|
|  |
| Kx2Pcs |

