











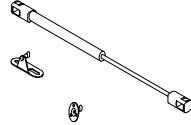
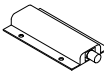

Hardware List

A  36PCS (M6*40)	B  10PCS (M8*40)	C  36PCS (ø12*15)	D  36PCS	E  58PCS (M4*12)
F  2PCS	G  2PCS	H  1PC	I  1PC	J  1PC
K  3PCS	L  4PCS (M8*25)	M  4PCS	N  4PCS	O  1PC
P  1PC		 1PC		

Panel List

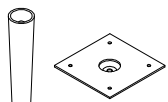
1  1PC	2  1PC	3  2PCS	4  1PC	5  1PC
6  1PC	7  1PC	8  1PC	9  1PC	10  2PCS
11  1PC	12  1PC	13  1PC	14  1PC	

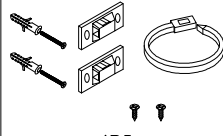
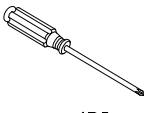
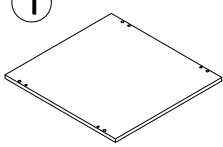
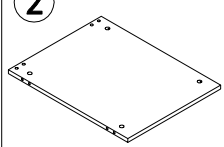
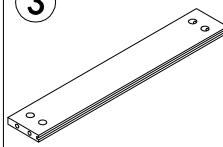
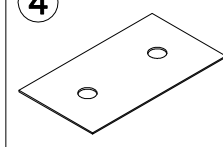
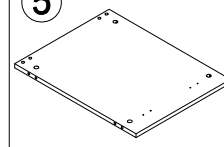
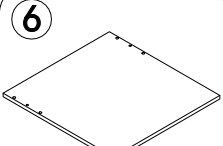
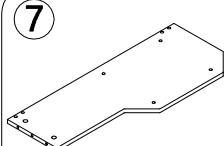
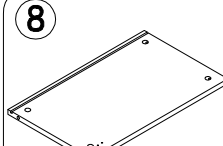
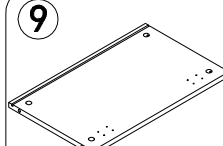
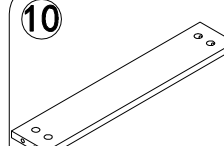
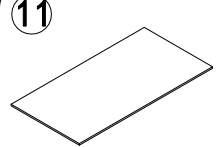
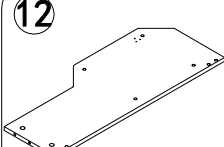
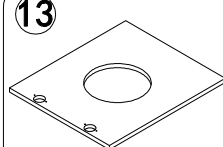
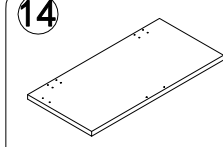
Assembling the unit with camlocks and wood dowels

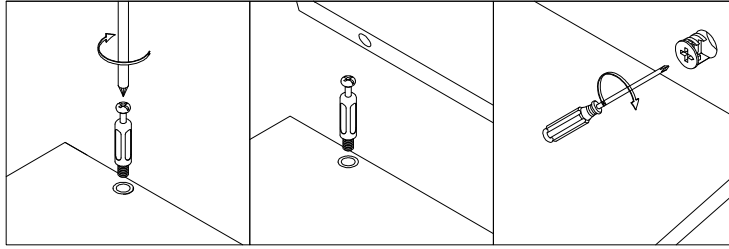

Assembly instructions

step 1

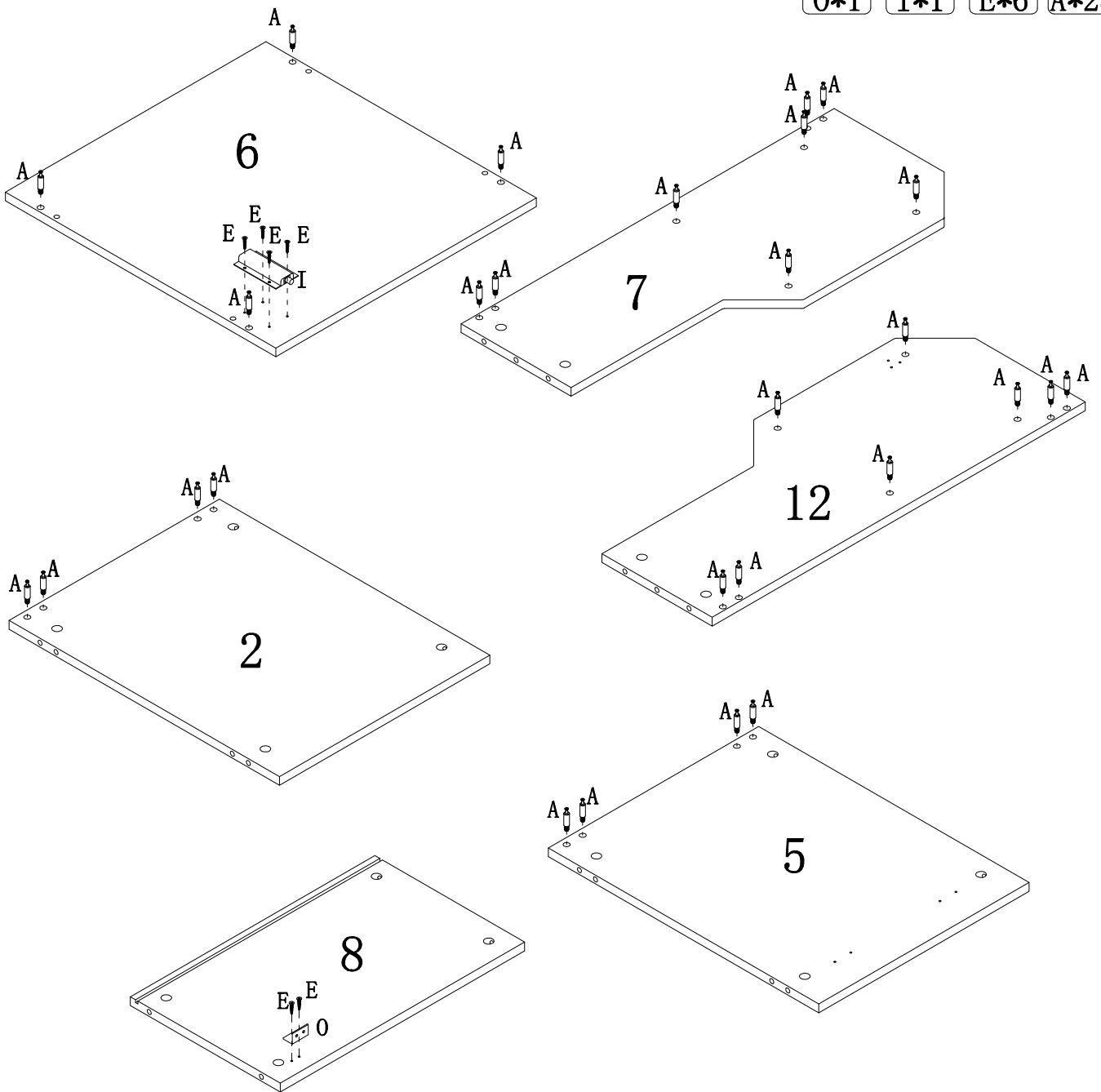
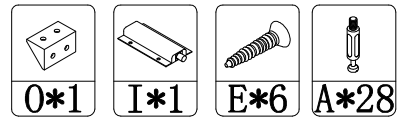

step 2

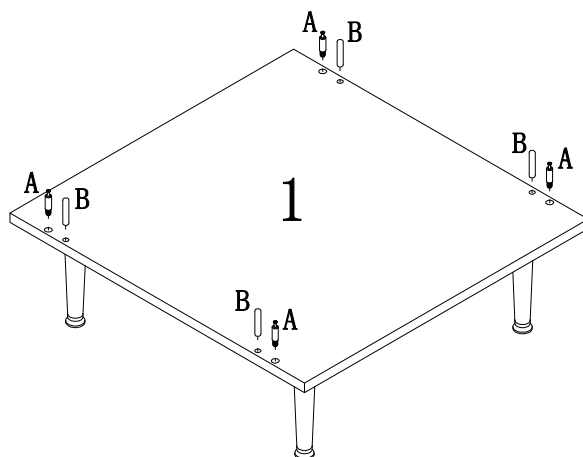
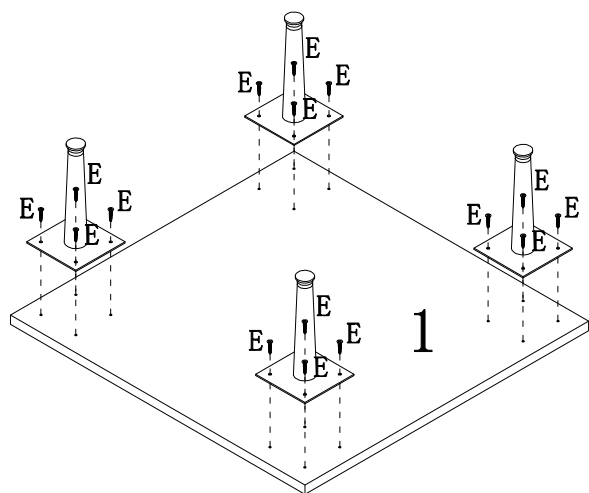
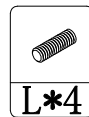
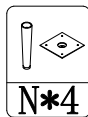
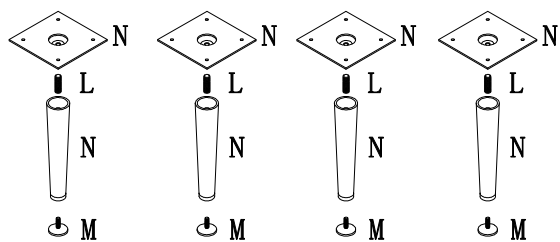

step 3

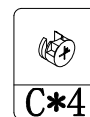
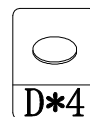
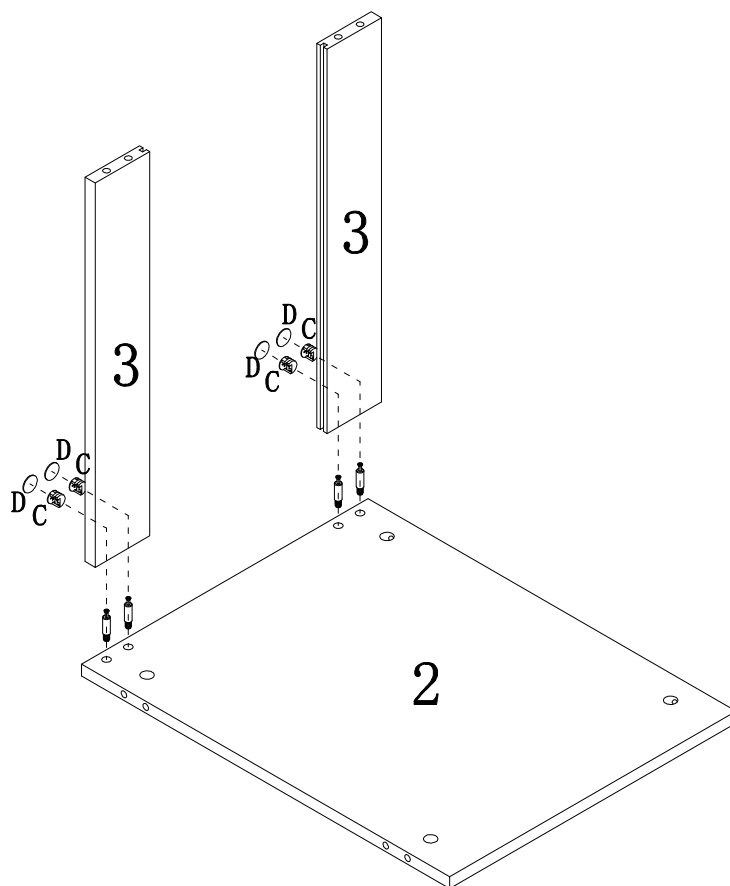

step 4

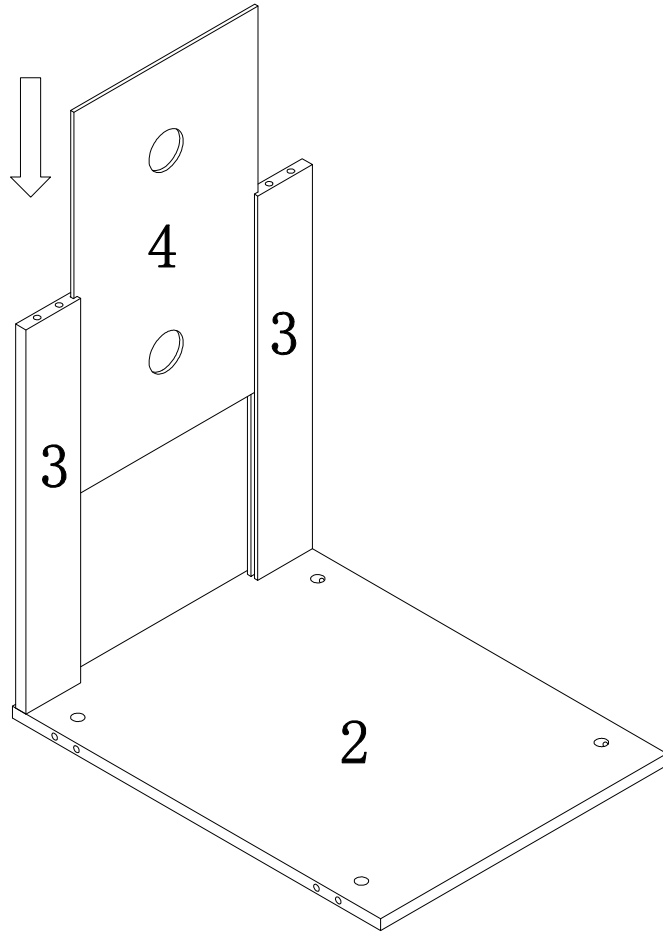

step 5

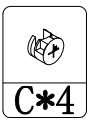
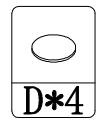
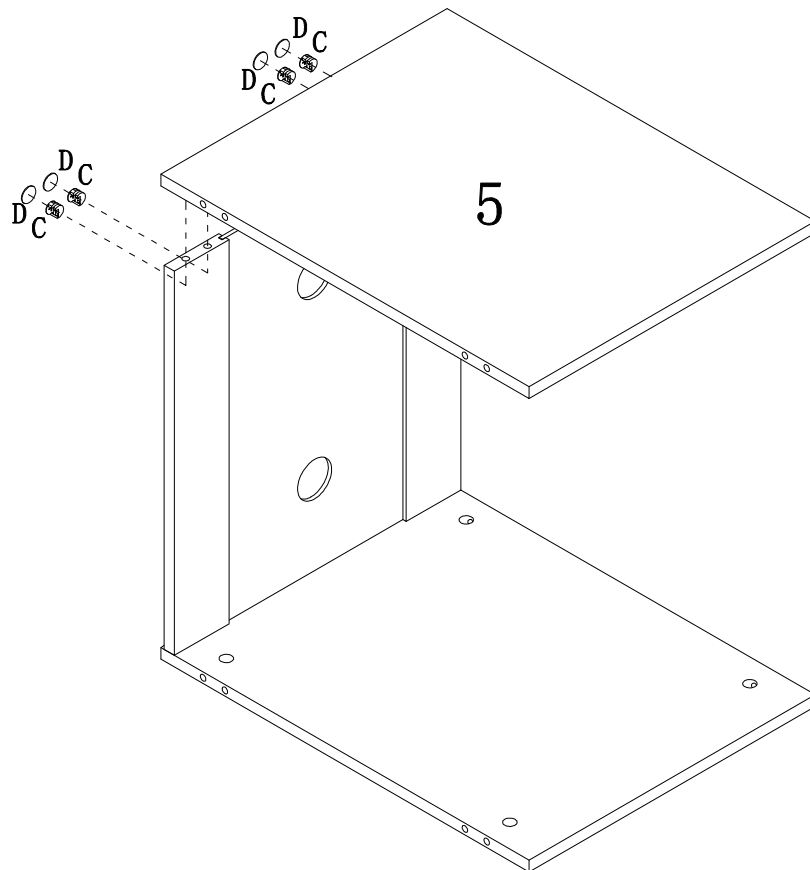

step 6

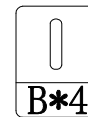
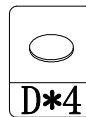
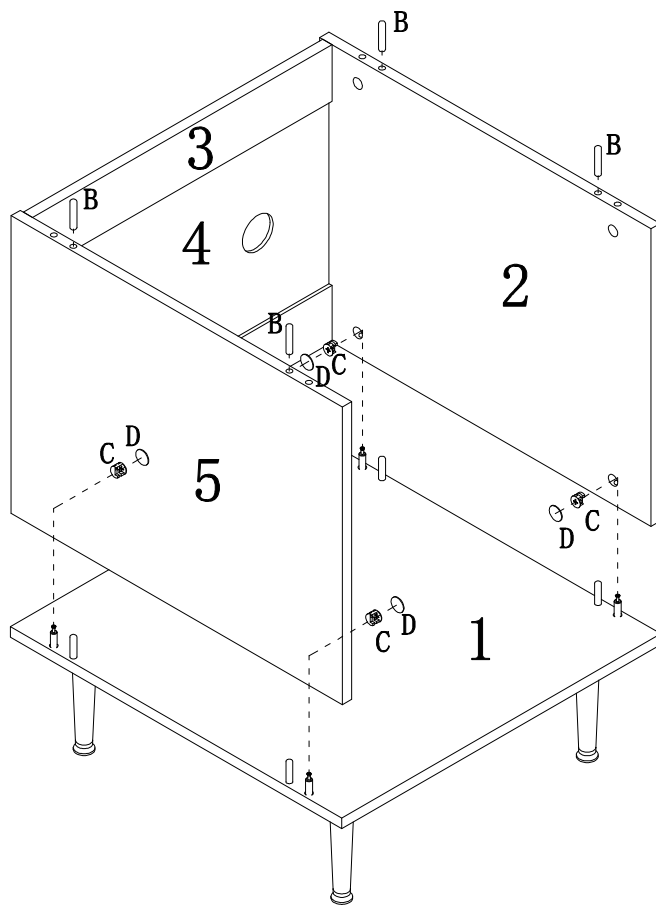

step 7

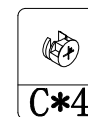
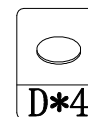
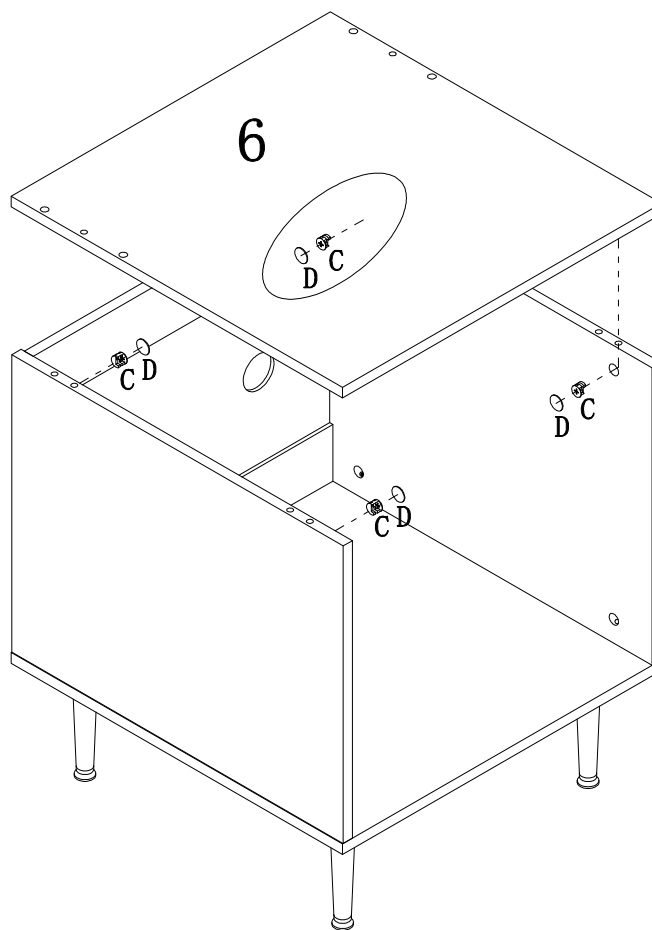

step 8

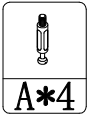
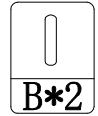
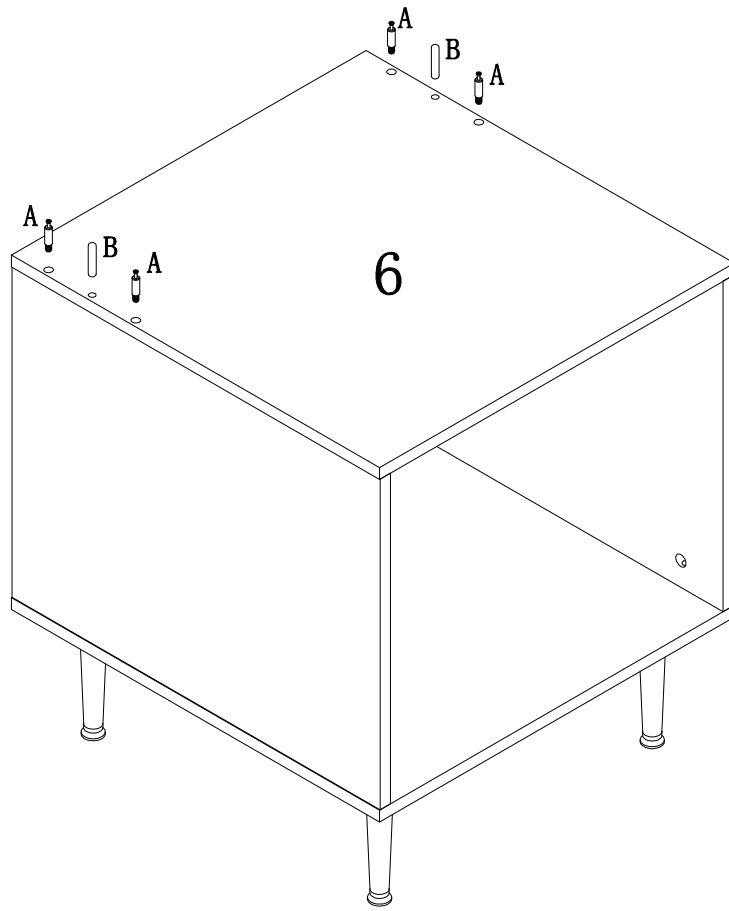

step 9

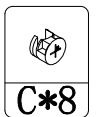
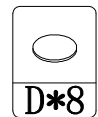
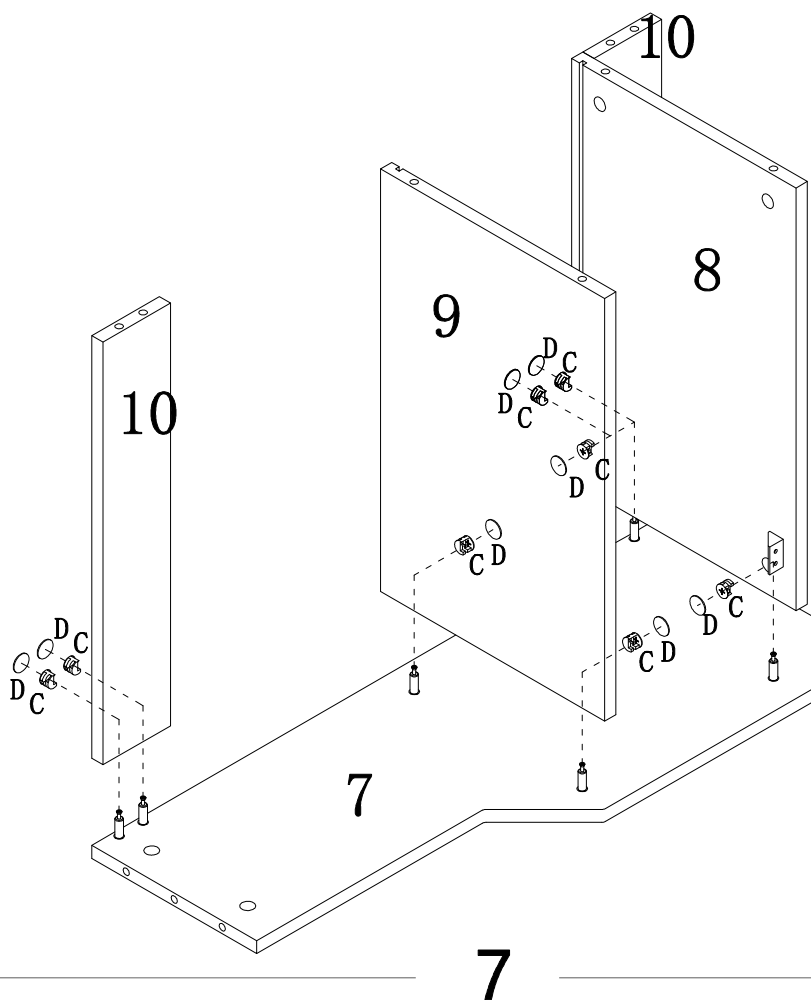

step 10

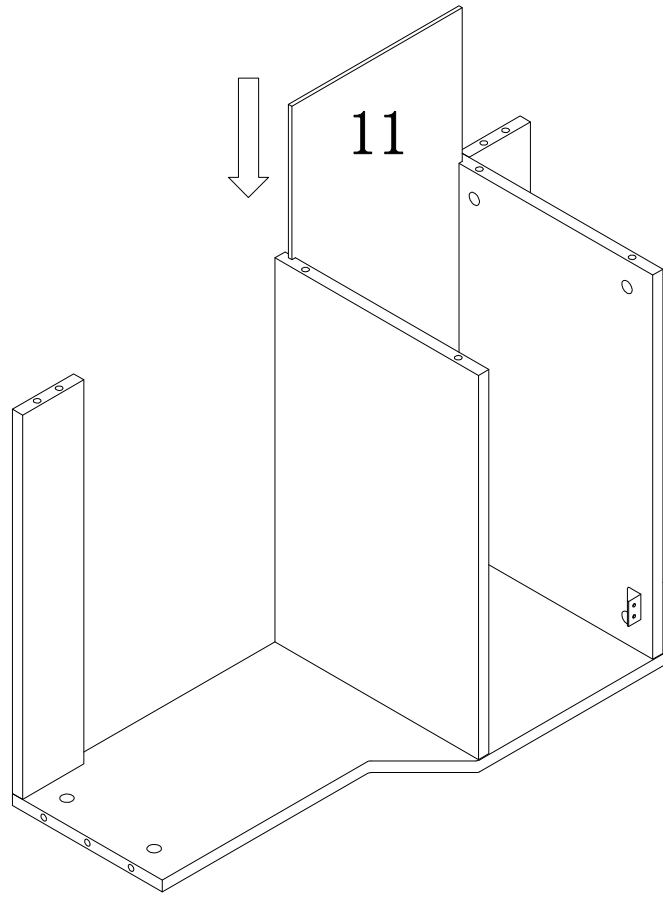

step 11

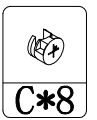
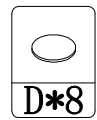
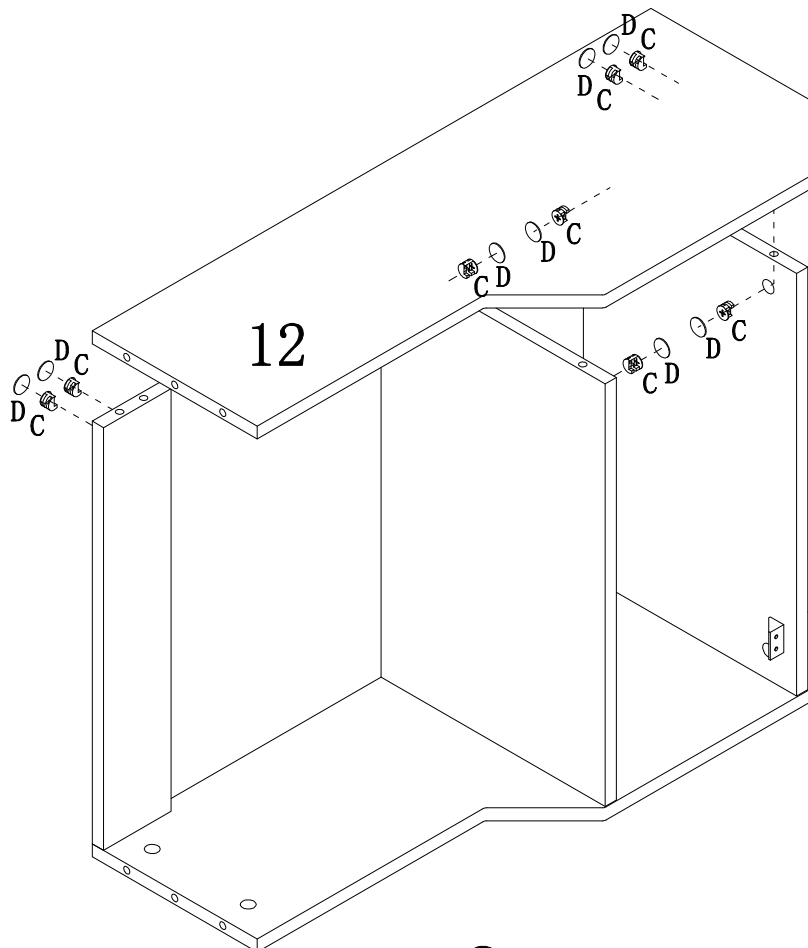

step 12

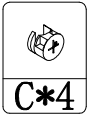
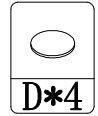
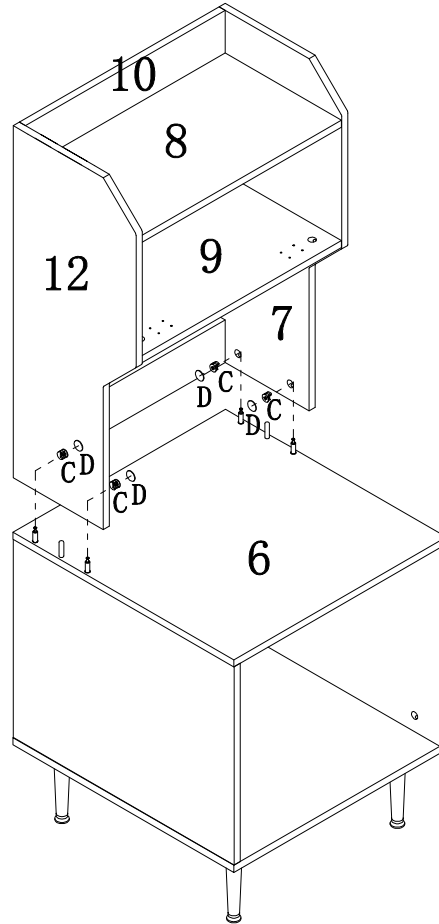

step 13

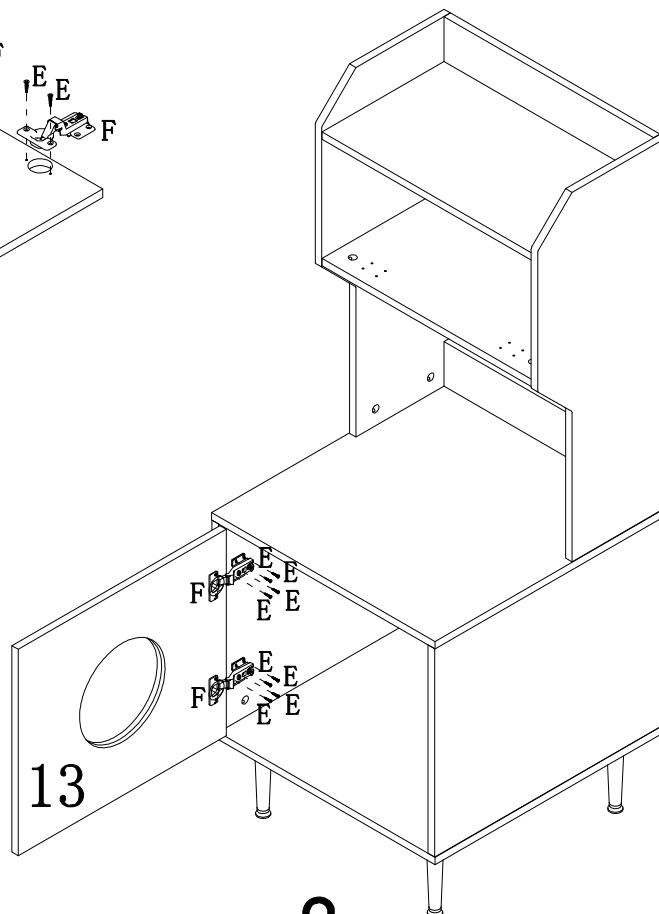
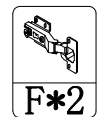
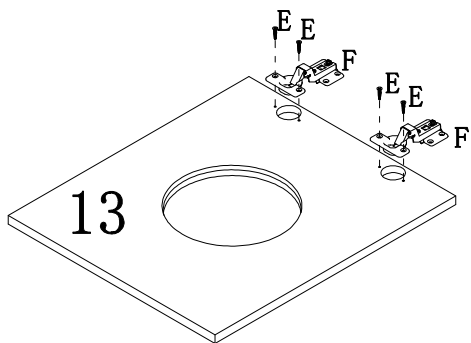

step 9

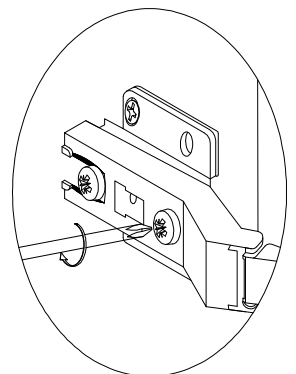
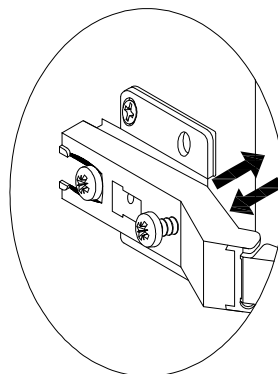
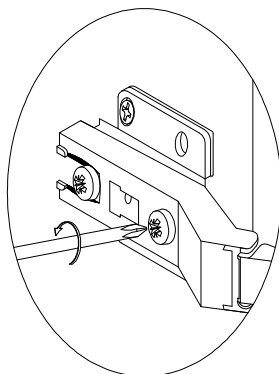
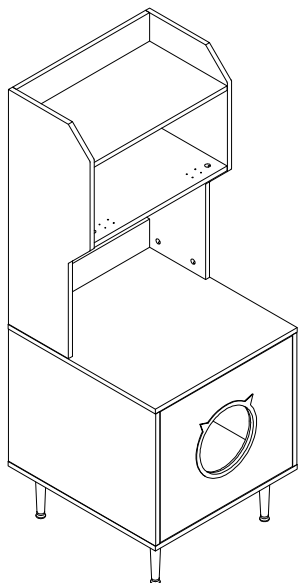
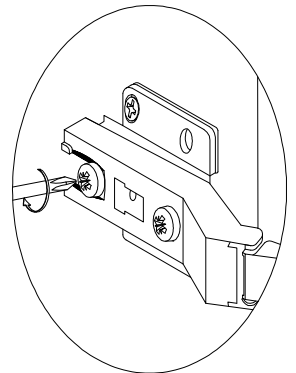
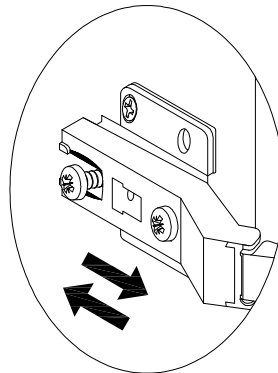
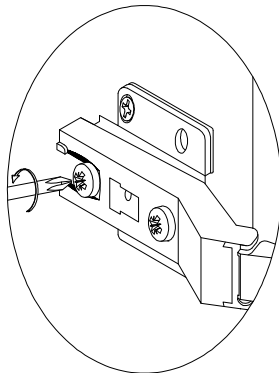
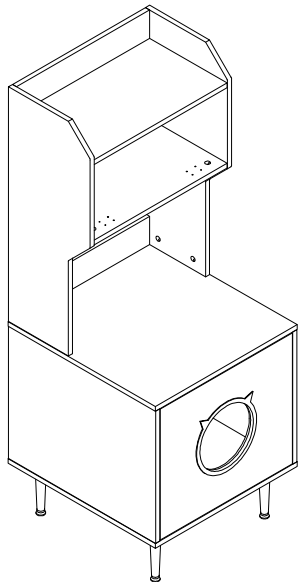
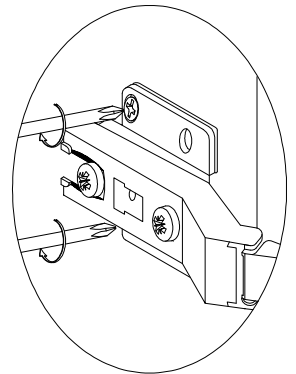
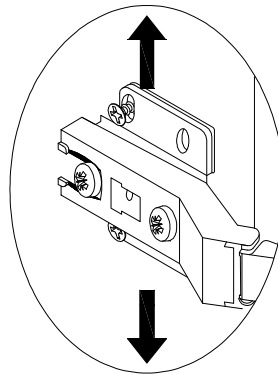
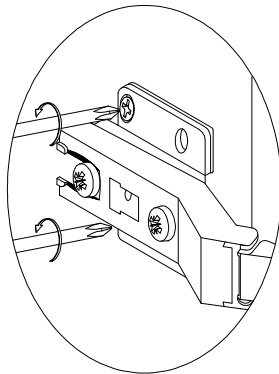
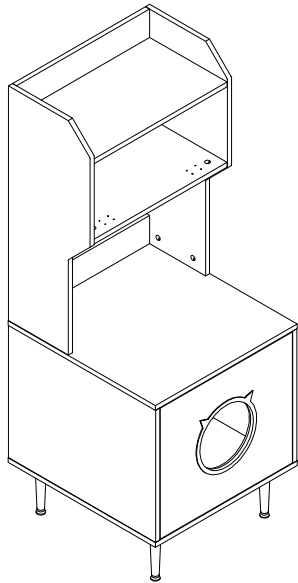

step 14

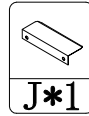
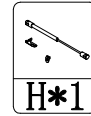
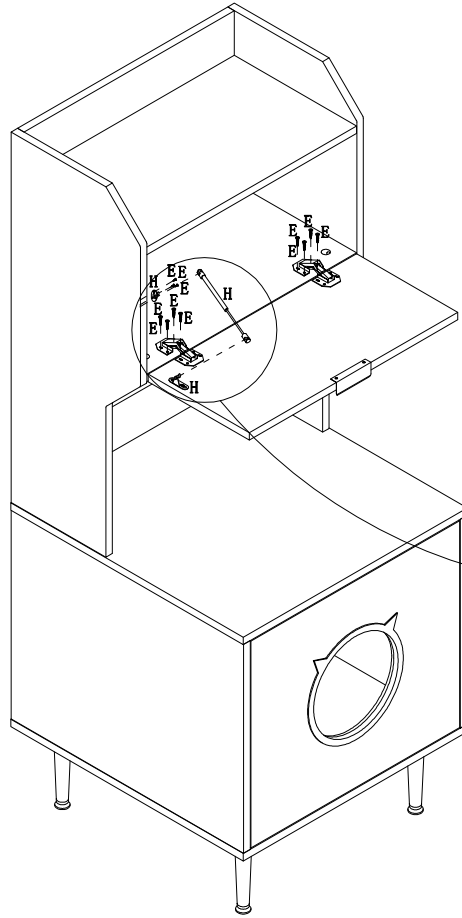
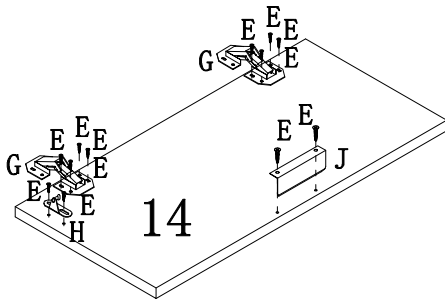

step 15

