

ASSEMBLY INSTRUCTIONS

TWIN BED

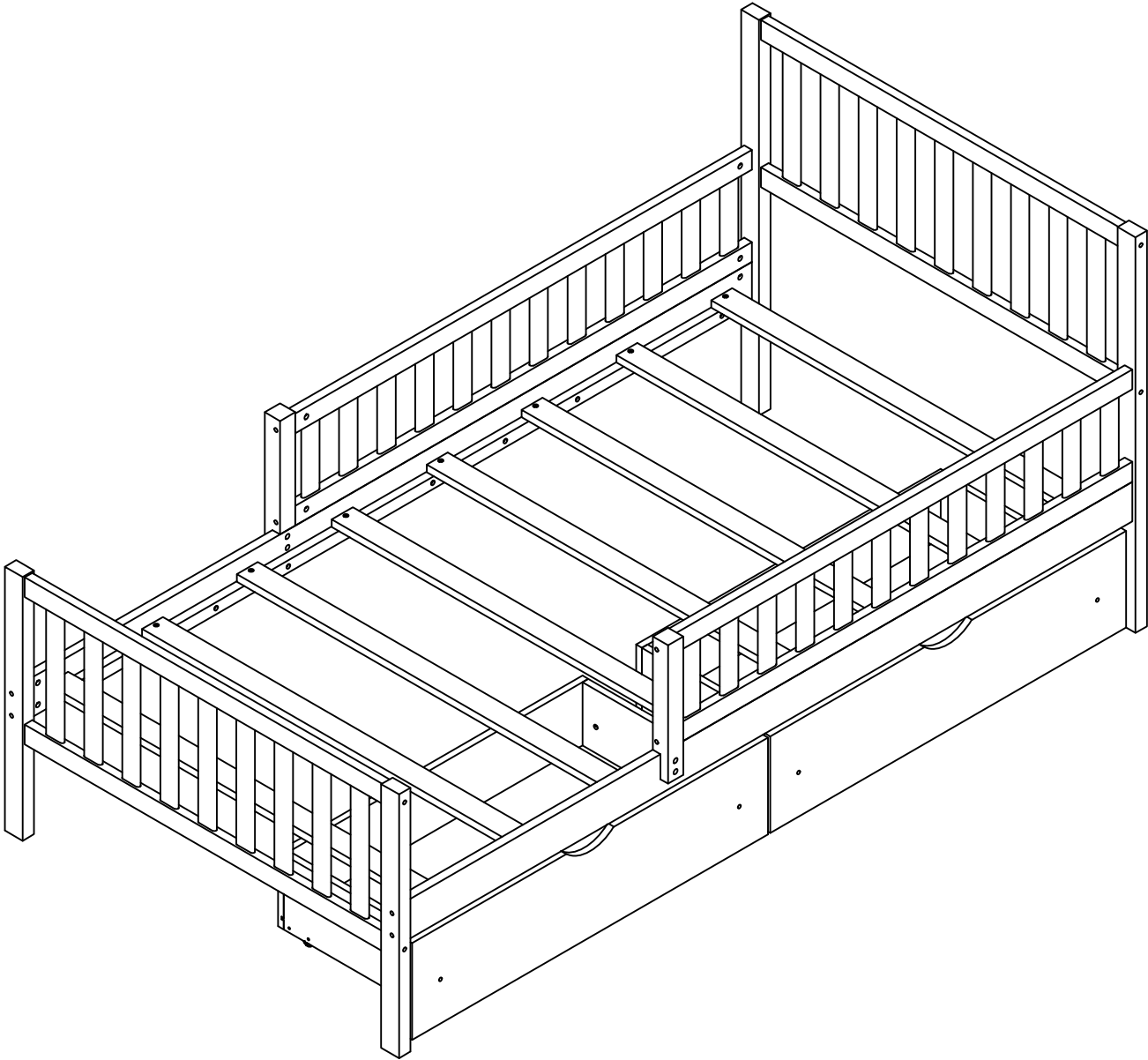



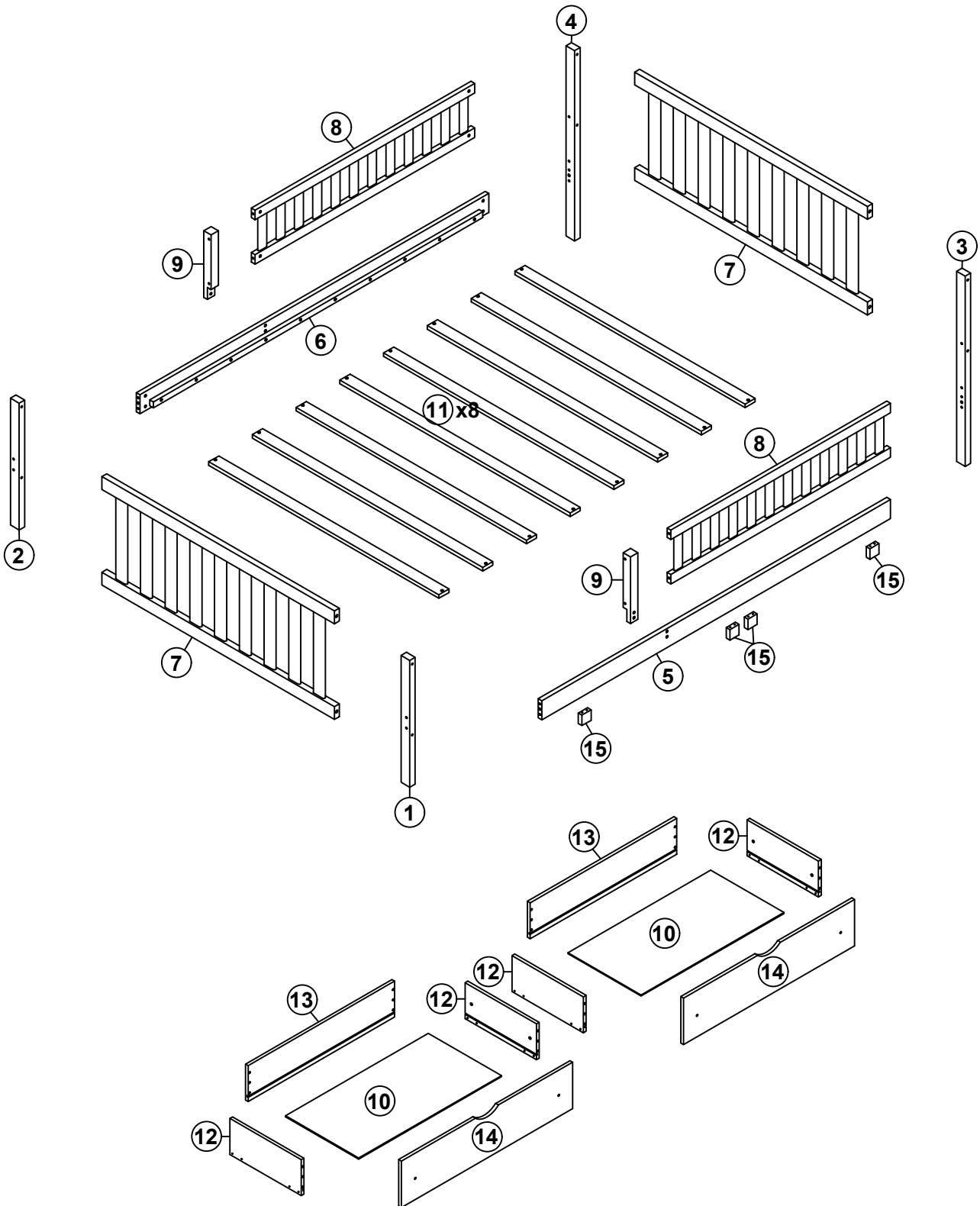

WF315870

ASSEMBLY INSTRUCTIONS



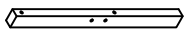
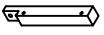
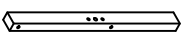
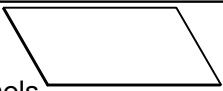
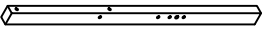
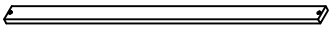
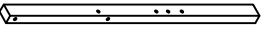
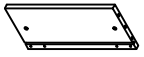
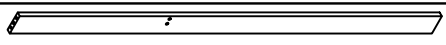
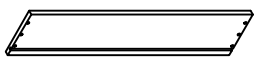
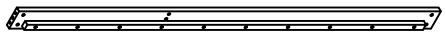

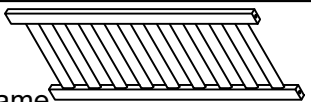

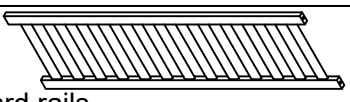



ASSEMBLY INSTRUCTIONS

WF315870 (Hardware in this SKU)

1	Leg 	1pc	9	Guard rails support 	2pcs
2	Leg 	1pc	10	Bottom drawers panels 	2pcs
3	Leg 	1pc	11	Slats 	8pcs
4	Leg 	1pc	12	Side drawers panels 	4pcs
5	Side rails 	1pc	13	Back drawers panels 	2pcs
6	Side rails 	1pc	14	Front drawers panels 	2pcs
7	Headboard frame 	2pcs	15	Support drawer 	4pcs
8	Frame guard rails 	2pcs			

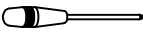

HARDWARE LIST (WF315870)

A	Ø4x30 	40PCS	F	Ø10x40 	4PCS
B	1/4x90 	12PCS	G	Ø8x30 	16PCS
C	1/4x75 	12PCS	H	4x58 	1PC
D	1/4x60 	8PCS	I		8PCS
E	1/4x35 	4PCS		Phillip head screw Not include 	

ASSEMBLY INSTRUCTIONS

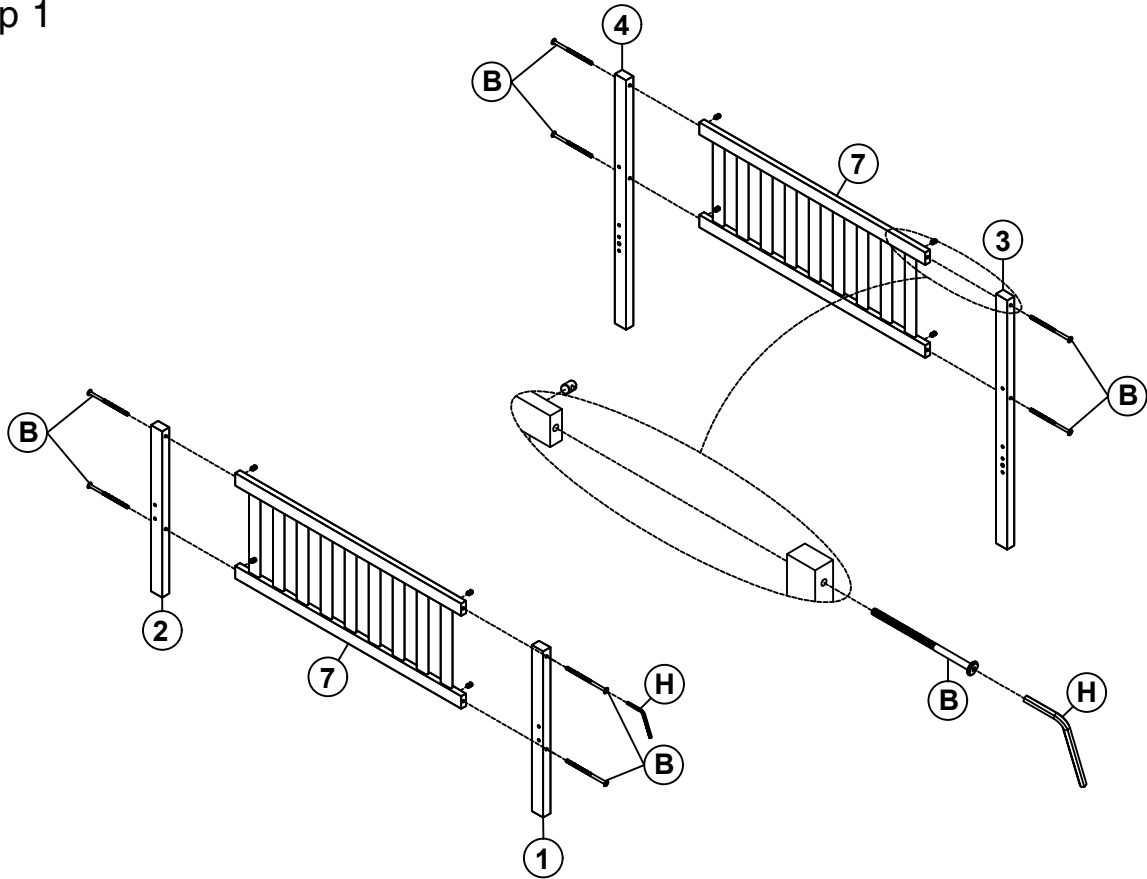

Step 1

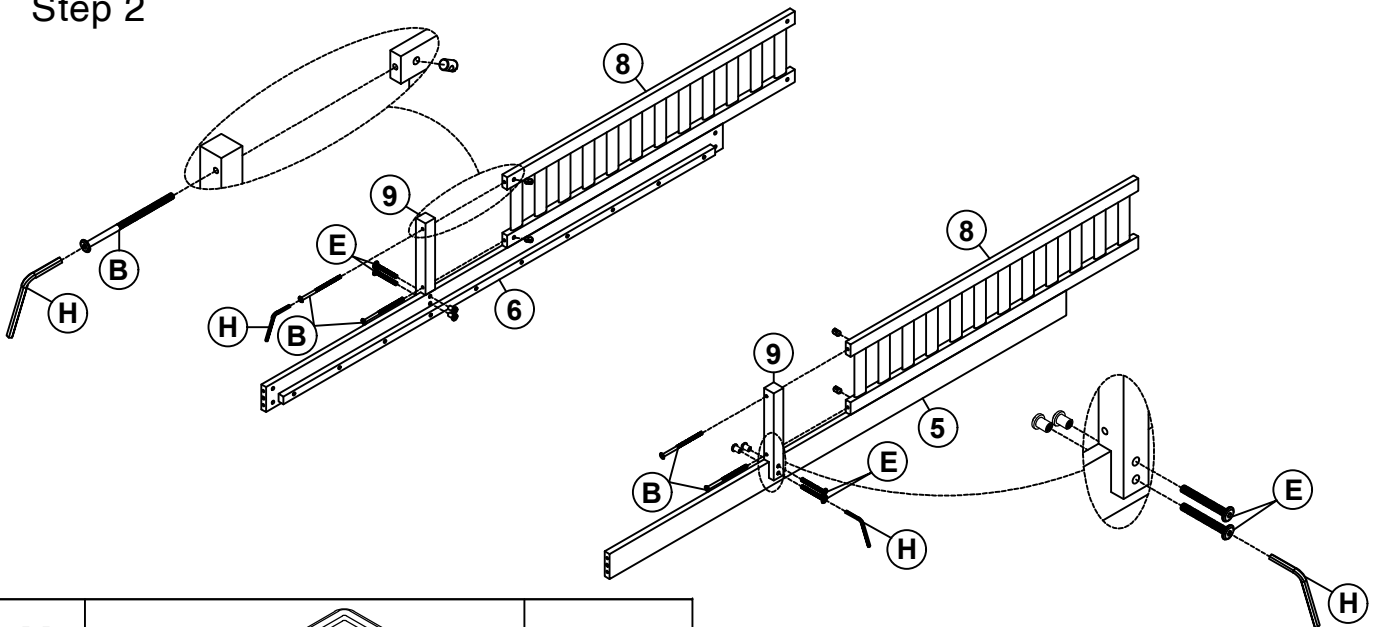

B	1/4x90		8PCS	H	4x58		1PC
----------	--------	---	------	----------	------	---	-----

Step 2



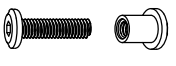

H	4x58		1PC	B	1/4x90		4PCS
E	1/4x35		4PCS				

ASSEMBLY INSTRUCTIONS

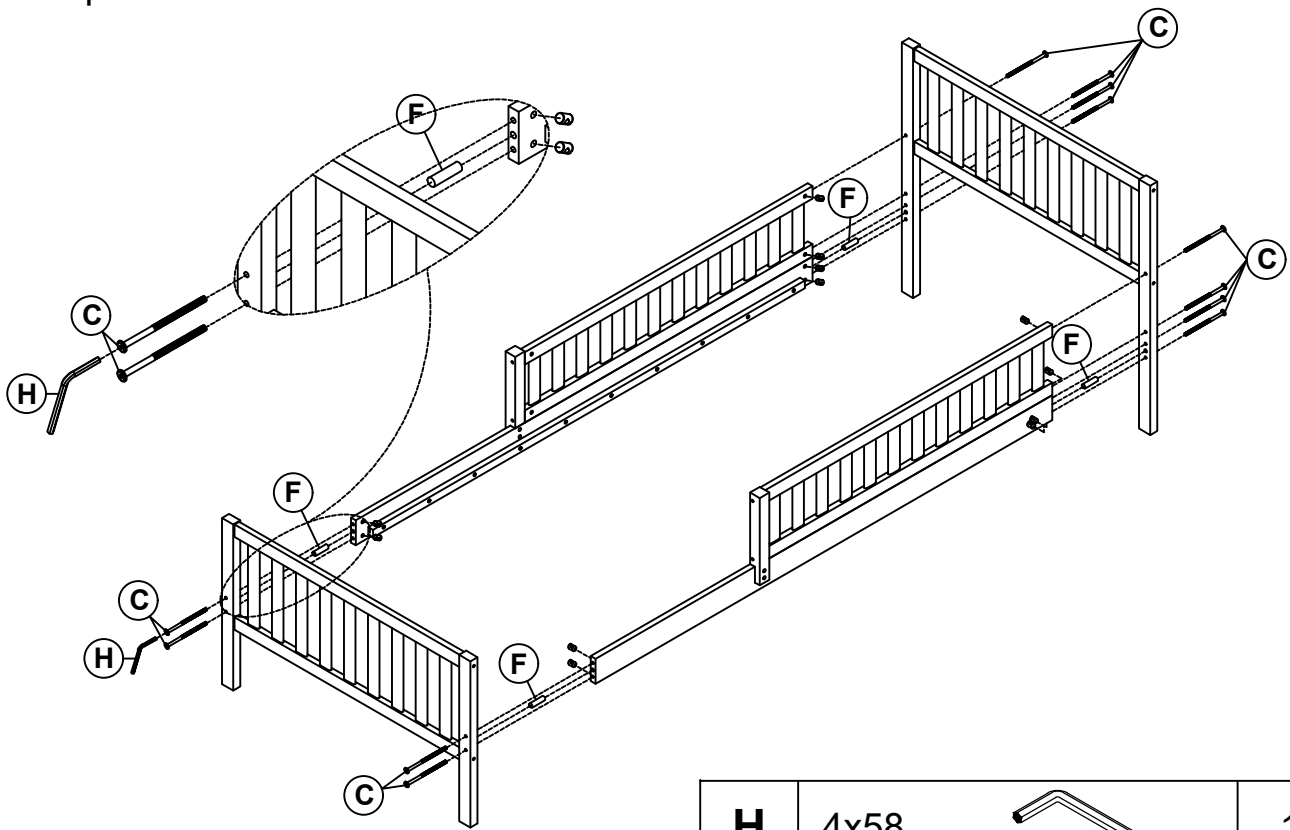
Step 3



H	4x58		1PC
C	1/4x75		12PCS
F	Ø10x40		4PCS

Step 4

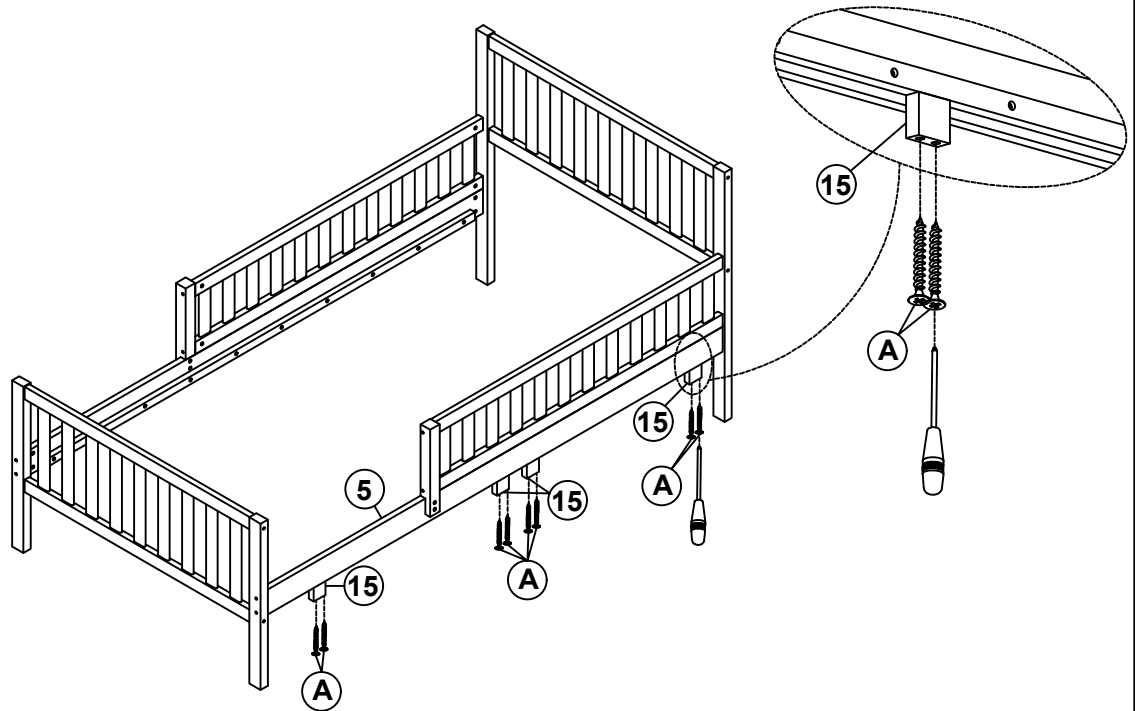

A	Ø4x30		8PCS
----------	-------	---	------

ASSEMBLY INSTRUCTIONS



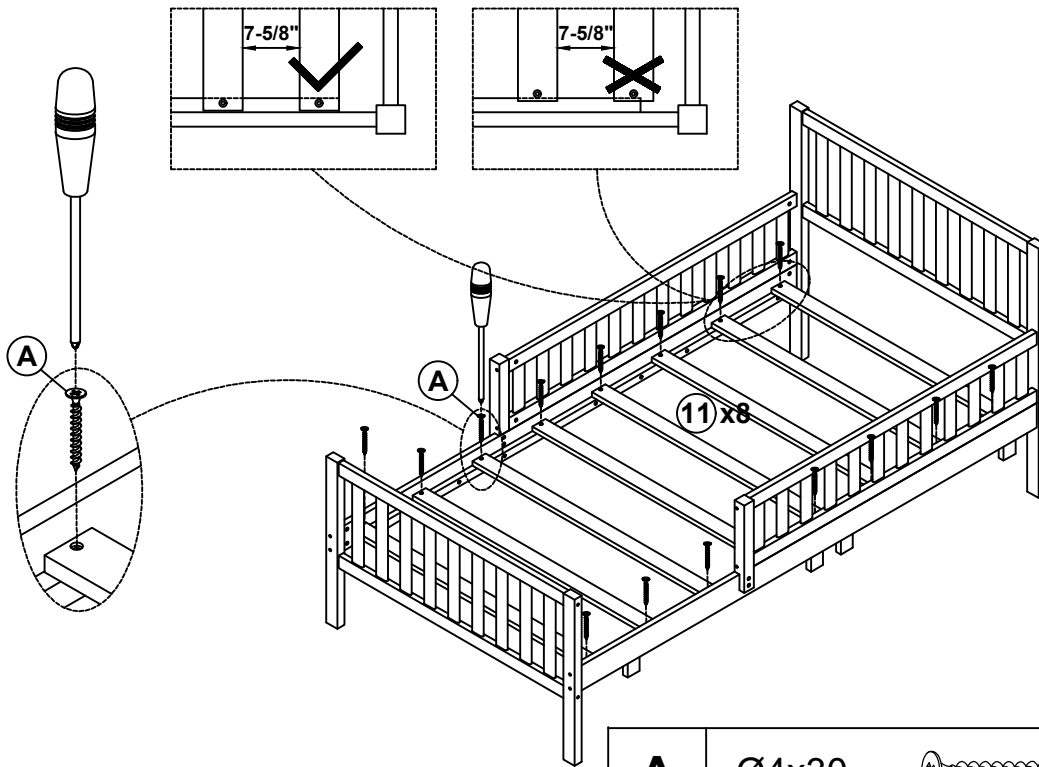

Step 5 First attach 2pcs part 11 to the front and end of the frame, between side rails. Then attach the remaining part 11 equidistantly between side rails.

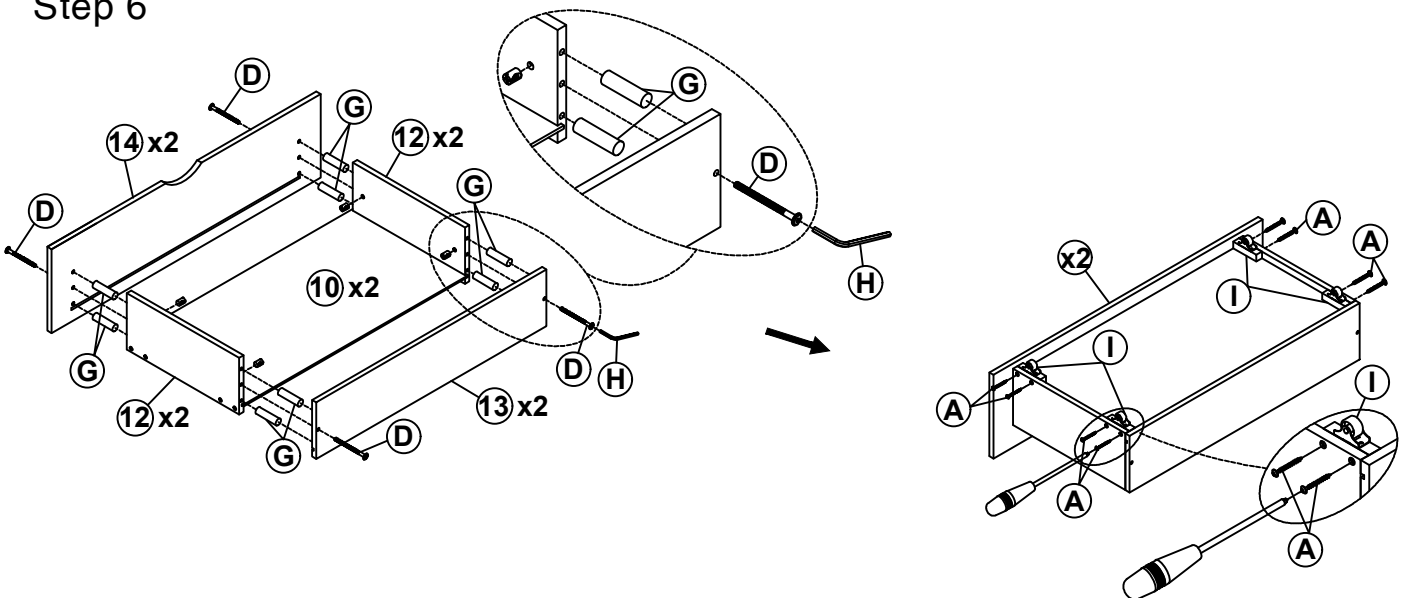

A	Ø4x30		16PCS
----------	-------	---	-------

Step 6



				I		8PCS	
A	Ø4x30		16PCS	H	4x58		1PC
G	Ø8x30		16PCS	D	1/4x60		8PCS

ASSEMBLY INSTRUCTIONS

Step 7

