

ASSEMBLY INSTRUCTIONS

WF303336

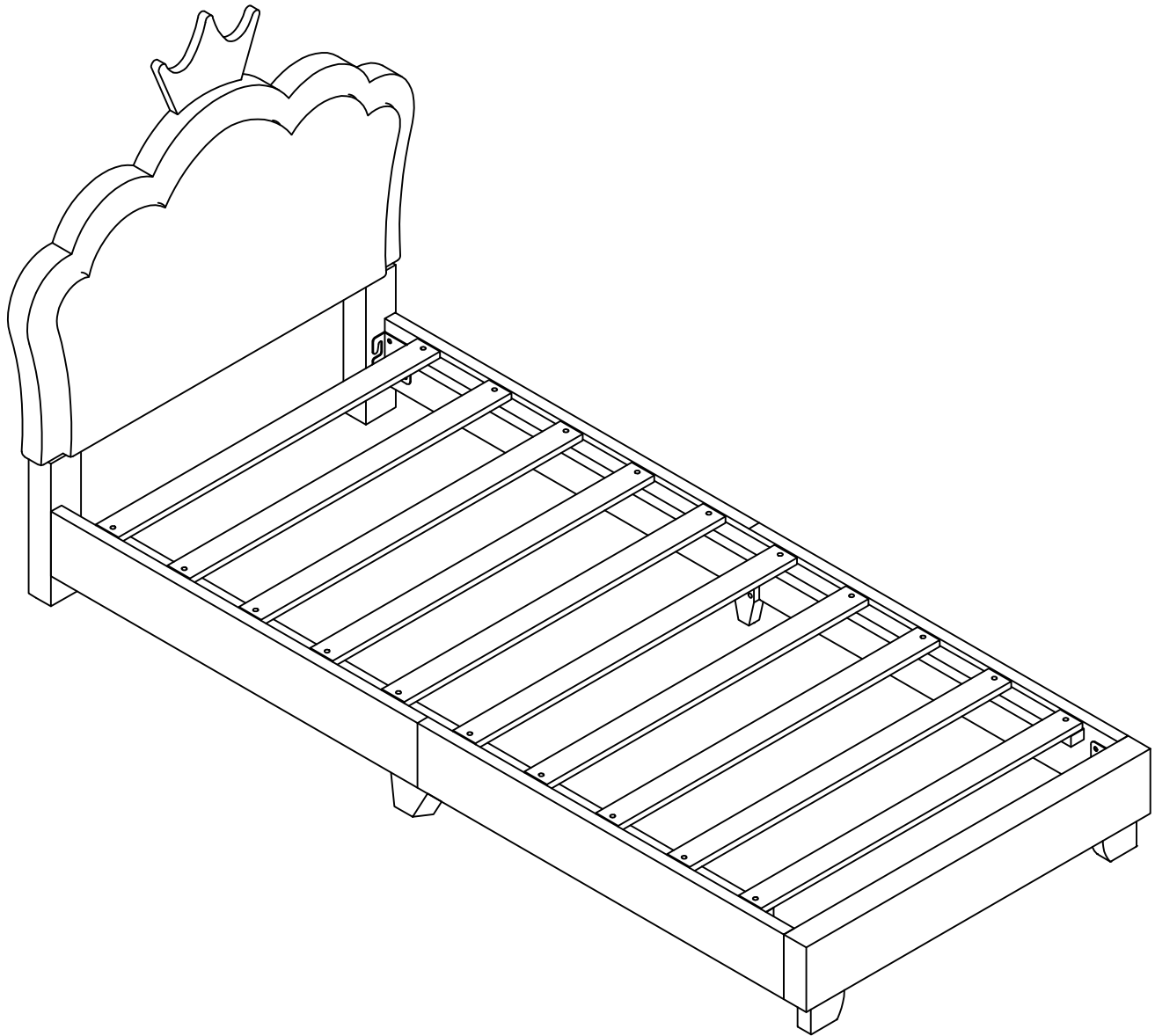

IMPORTANT NOTE

- **PLACE ALL PARTS ON A CLEAN AND SMOOTH SURFACE SUCH AS A RUG OR CARPET TO AVOID THE PARTS FROM BEING SCRATCHED**
- ** BEFORE YOU BEGIN , KINDY FOLLOW THE ASSEMBLY INSTRUCTIONS STEP BY STEP**
- **DO NOT TIGHTEN ALL SCREWS AND BOLTS UNTIL THE BED IS FULLY SET-UP**

ASSEMBLY INSTRUCTIONS



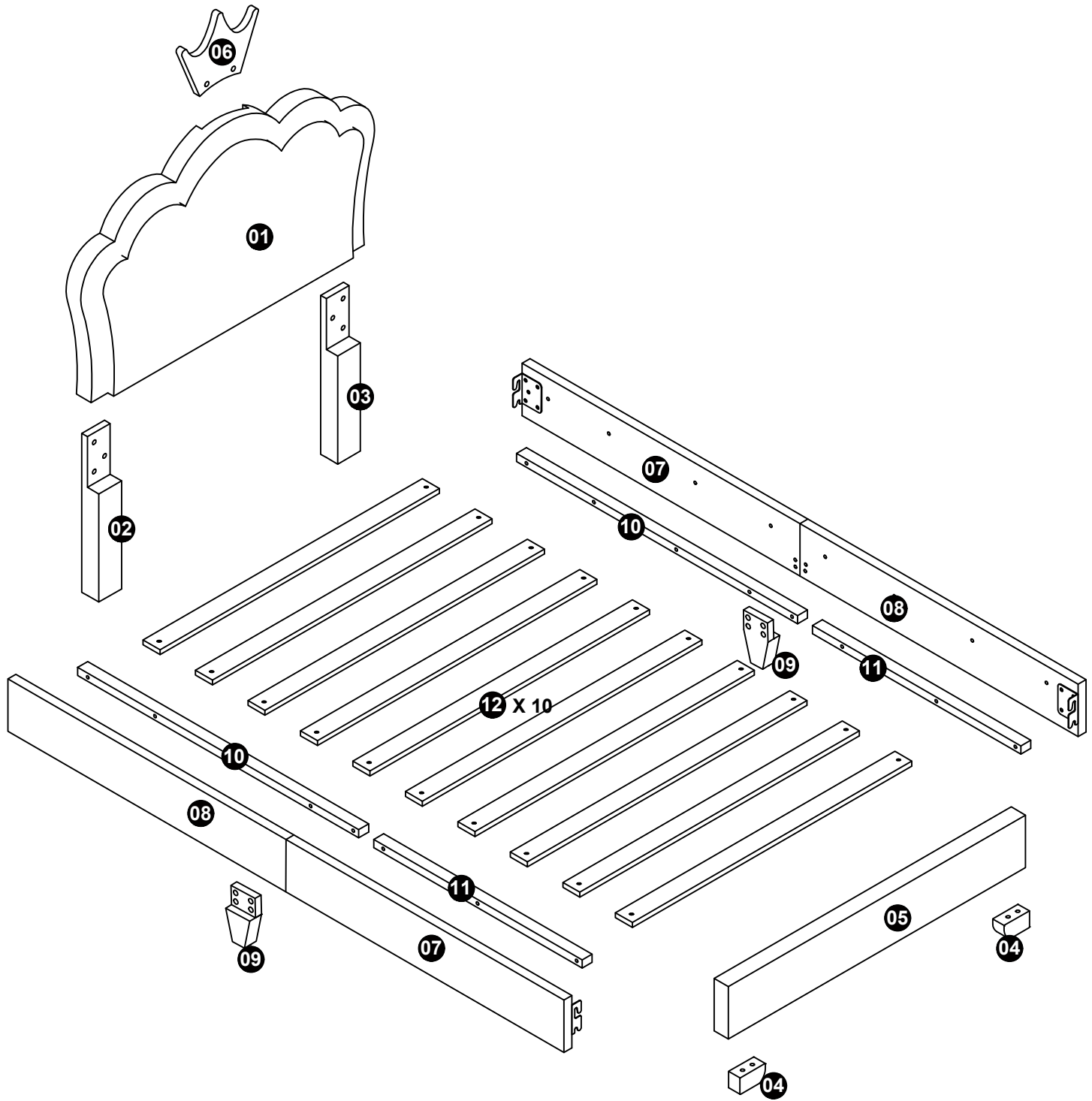



WF303336

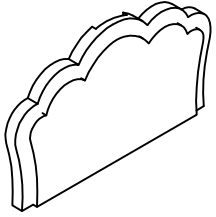
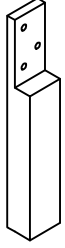
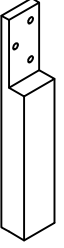

ASSEMBLY INSTRUCTIONS

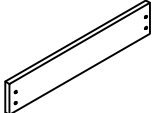
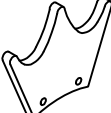
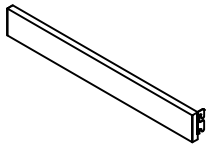
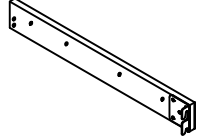
WF303336

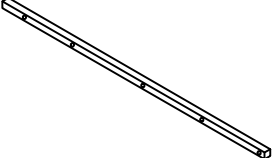
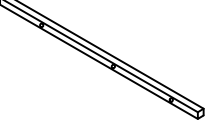
PART LIST BOX 1: 303336

<p>1</p>  <p>Headboard Panel (1 pc)</p>	<p>2</p>  <p>Left Headboard leg(1 pc)</p>	<p>3</p>  <p>Right Headboard Leg(1 pc)</p>
<p>4</p>  <p>Leg (2 pcs)</p>	<p>5</p>  <p>Footboard Panel (1 pc)</p>	<p>6</p>  <p>Headboard crown (1 pc)</p>
<p>7</p>  <p>Left Lower Rail (2 pcs)</p>	<p>8</p>  <p>Right Lower Rail (2 pcs)</p>	<p>9</p>  <p>Rail support legs (2 pcs)</p>
<p>10</p>  <p>Bed Support Bar (2 pcs)</p>	<p>11</p>  <p>Bed Support Bar (2 pcs)</p>	<p>12</p>  <p>Roll Slat (10 pcs)</p>

ASSEMBLY INSTRUCTIONS

WF303336

HARDWARE LIST IN : 303336

A

Short Bolt (8pcs)
(Ø 5/16 "X25mm)

B

Long Bolt (2 pcs)
(Ø 5/16 "X32mm)

C

Long Bolt (14 pcs)
(Ø 5/16 "X38mm)

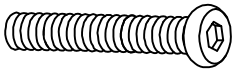
D

Long Bolt (16pcs)
(Ø 5/16 "X45mm)

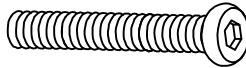
E

Long Bolt (2pcs)
(Ø 5/16 "X50mm)

F

Allen Wrench (1 pc)
(M4x75mm x32mm)

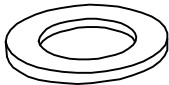
G

Flat Washer (42 pcs)
(Ø 5/16 "-RBW)

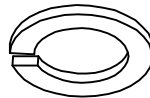
H

Spring Washer (42 pcs)
(Ø 5/16 "-RBW)

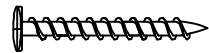



I

Flat Head Screw (20 pcs)
(m4x30mm-RBW)

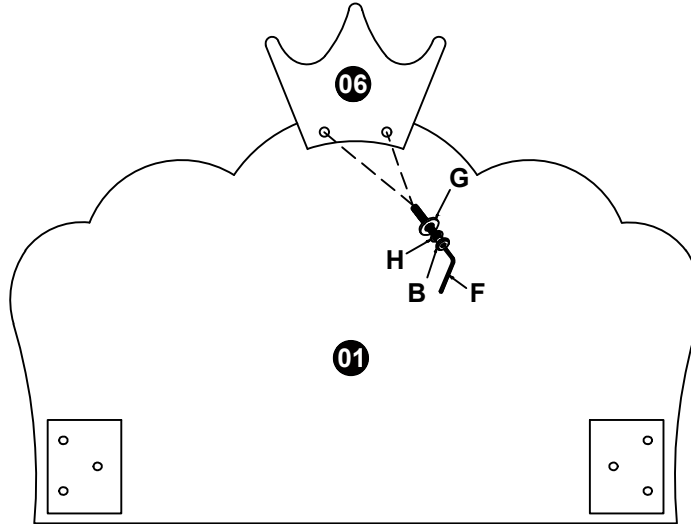
ASSEMBLY INSTRUCTIONS





STEP 1

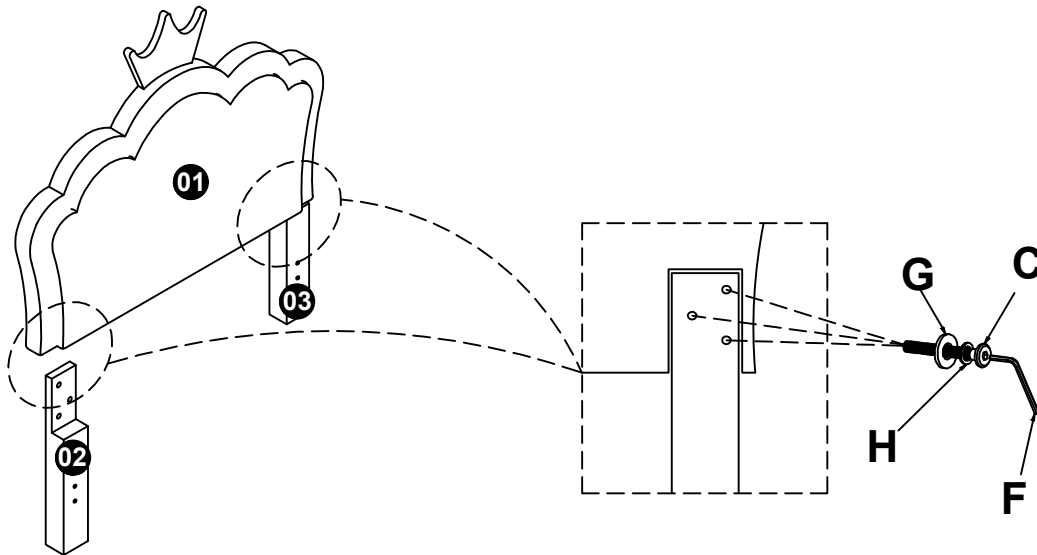

B	Bolt (Ø 5/16 "X32mm)		2pcs	G	Flat Washer (Ø 5/16 "-RBW)		2pcs
F	Allen Wrench (M4x75mm x32mm)		1pc	H	Spring Washer (Ø 5/16 "-RBW)		2pcs

STEP 2





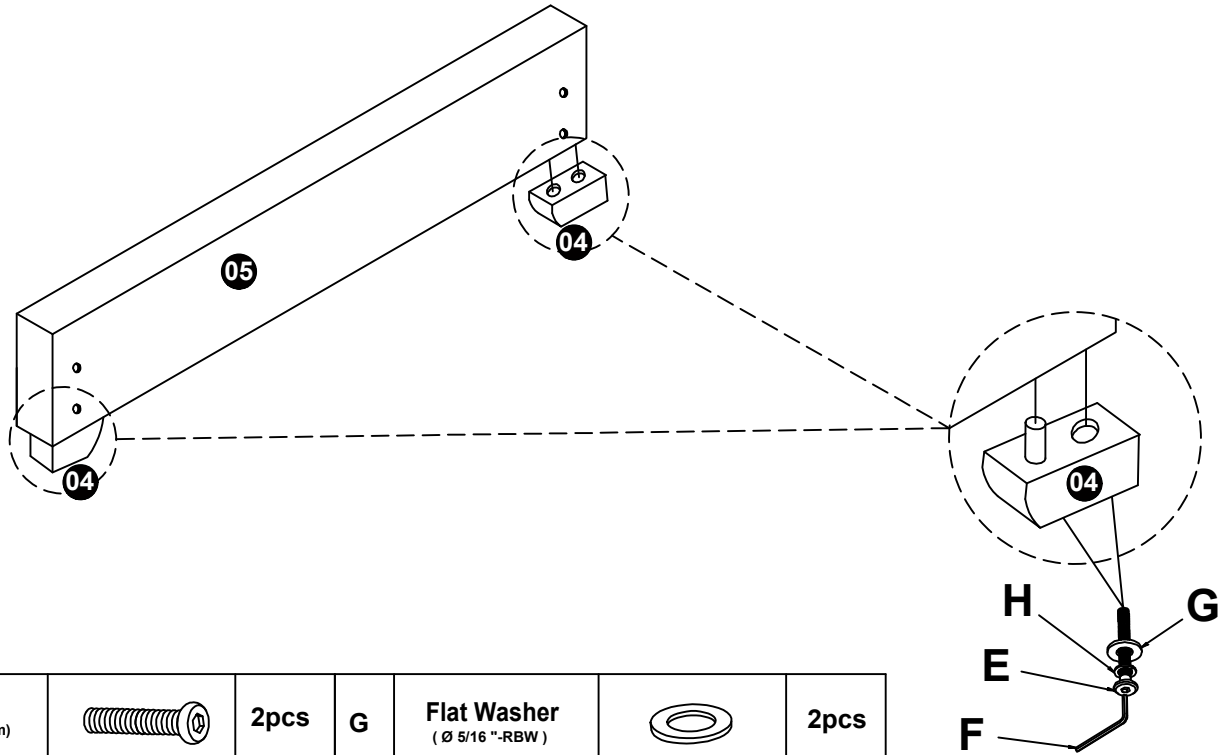

C	Bolt (Ø 5/16 "X38mm)		6pcs	G	Flat Washer (Ø 5/16 "-RBW)		6pcs
F	Allen Wrench (M4x75mm x32mm)		1pc	H	Spring Washer (Ø 5/16 "-RBW)		6pcs

ASSEMBLY INSTRUCTIONS





STEP 3

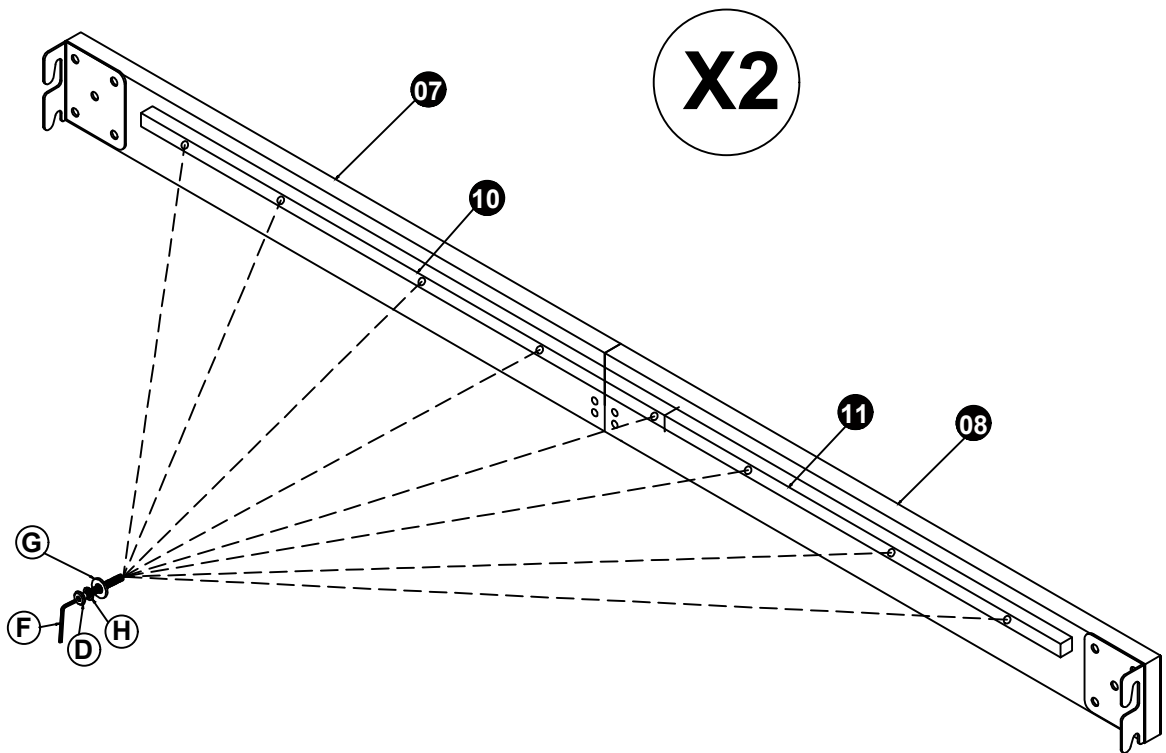

E	Bolt (Ø 5/16 "X50mm)		2pcs	G	Flat Washer (Ø 5/16 "-RBW)		2pcs
F	Allen Wrench (M4x75mm x32mm)		1pc	H	Spring Washer (Ø 5/16 "-RBW)		2pcs

STEP 4





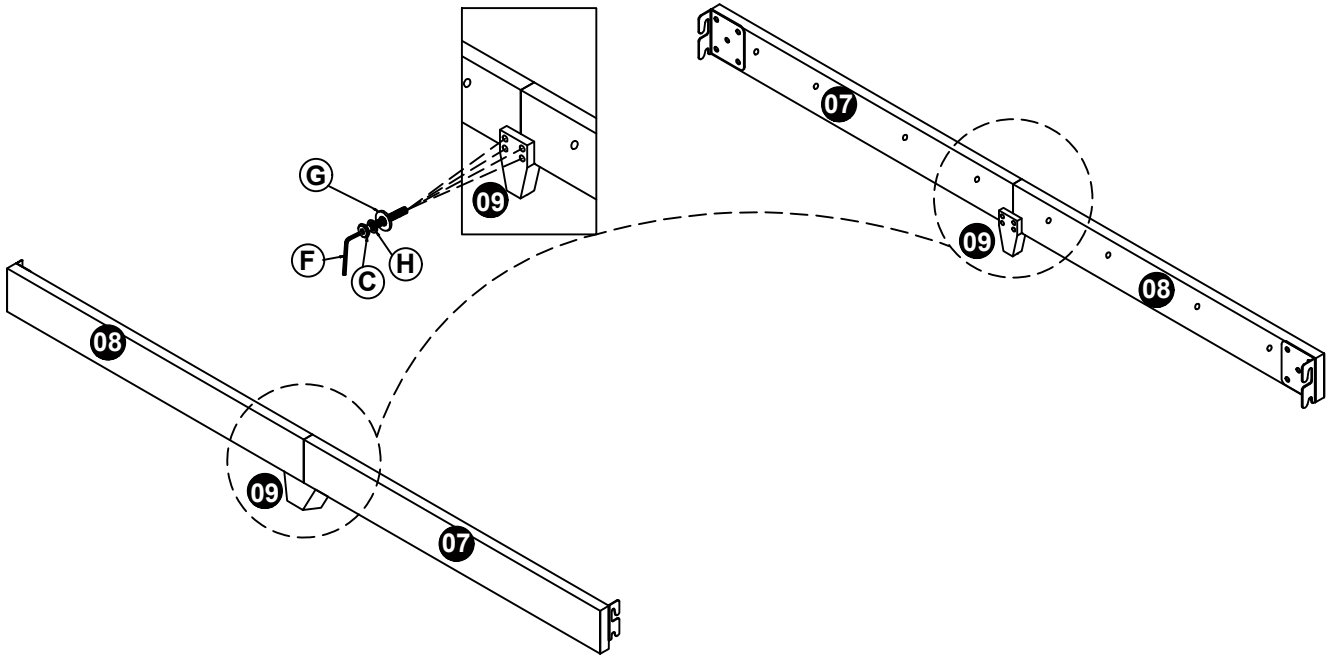

D	Bolt (Ø 5/16 "X45mm)		16pcs	G	Flat Washer (Ø 5/16 "-RBW)		16pcs
F	Allen Wrench (M4x75mm x32mm)		1pc	H	Spring Washer (Ø 5/16 "-RBW)		16pcs

ASSEMBLY INSTRUCTIONS





STEP 5

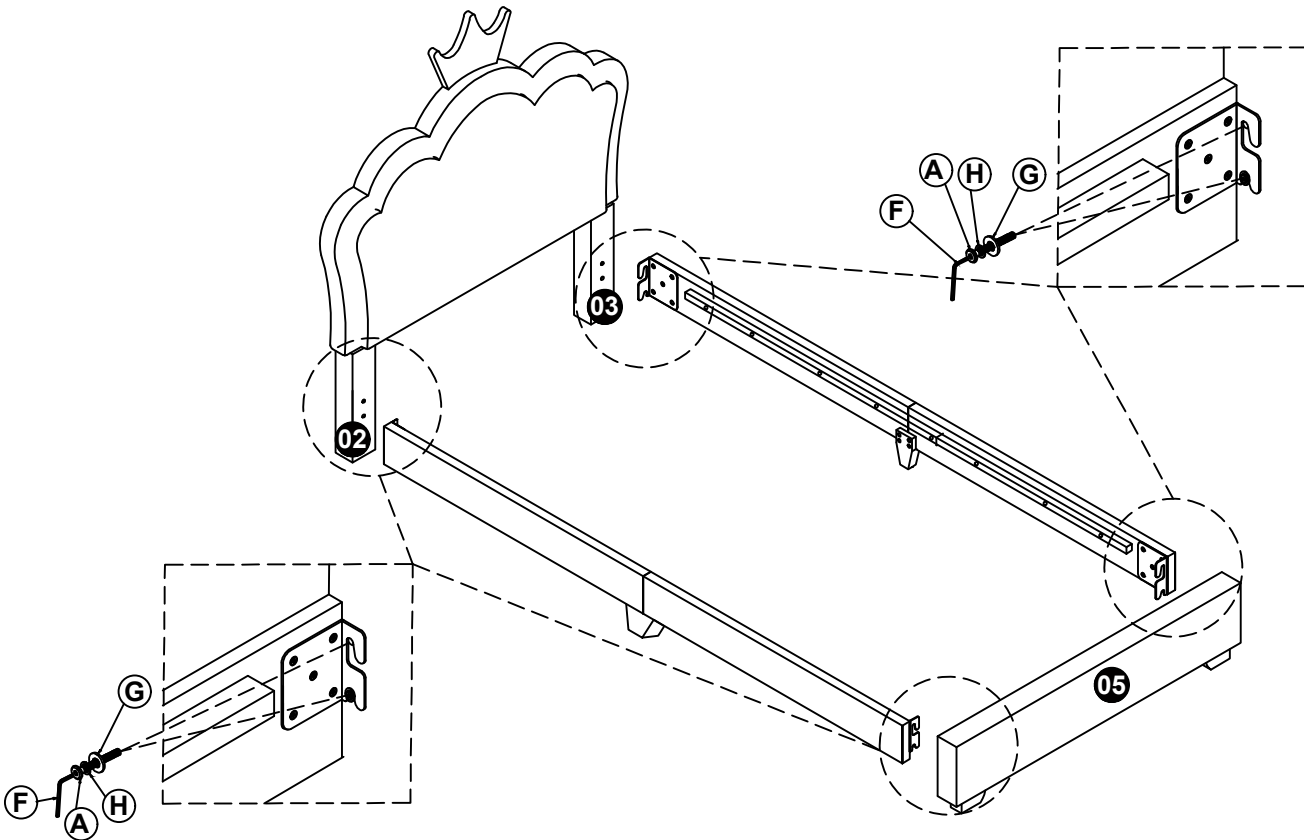

C	Bolt (Ø 5/16 "X38mm)		8pcs	G	Flat Washer (Ø 5/16 "-RBW)		8pcs
F	Allen Wrench (M4x75mm x32mm)		1pc	H	Spring Washer (Ø 5/16 "-RBW)		8pcs

STEP 6



A	Bolt (Ø 5/16 "X25mm)		8pcs	G	Flat Washer (Ø 5/16 "-RBW)		8pcs
F	Allen Wrench (M4x75mm x32mm)		1pc	H	Spring Washer (Ø 5/16 "-RBW)		8pcs

ASSEMBLY INSTRUCTIONS

STEP 7

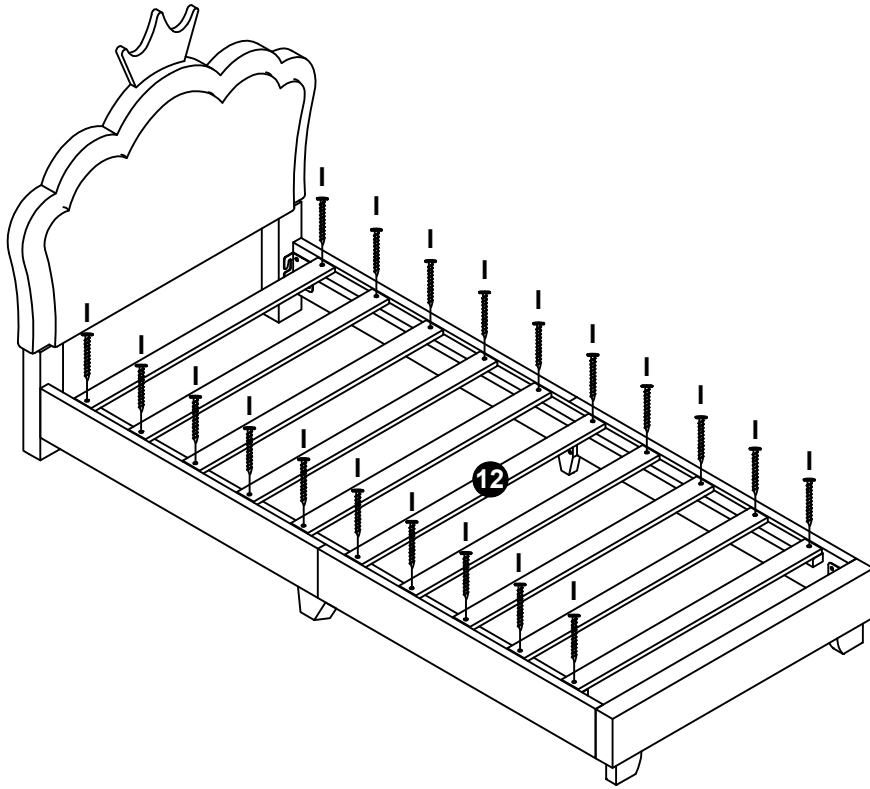

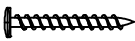
1	Flat Head Screw (m4x30mm-RBW)		20pcs
---	----------------------------------	---	-------

STEP 8 COMPLETE

