

# ASSEMBLY INSTRUCTION

**SKU CODE: WF309182**

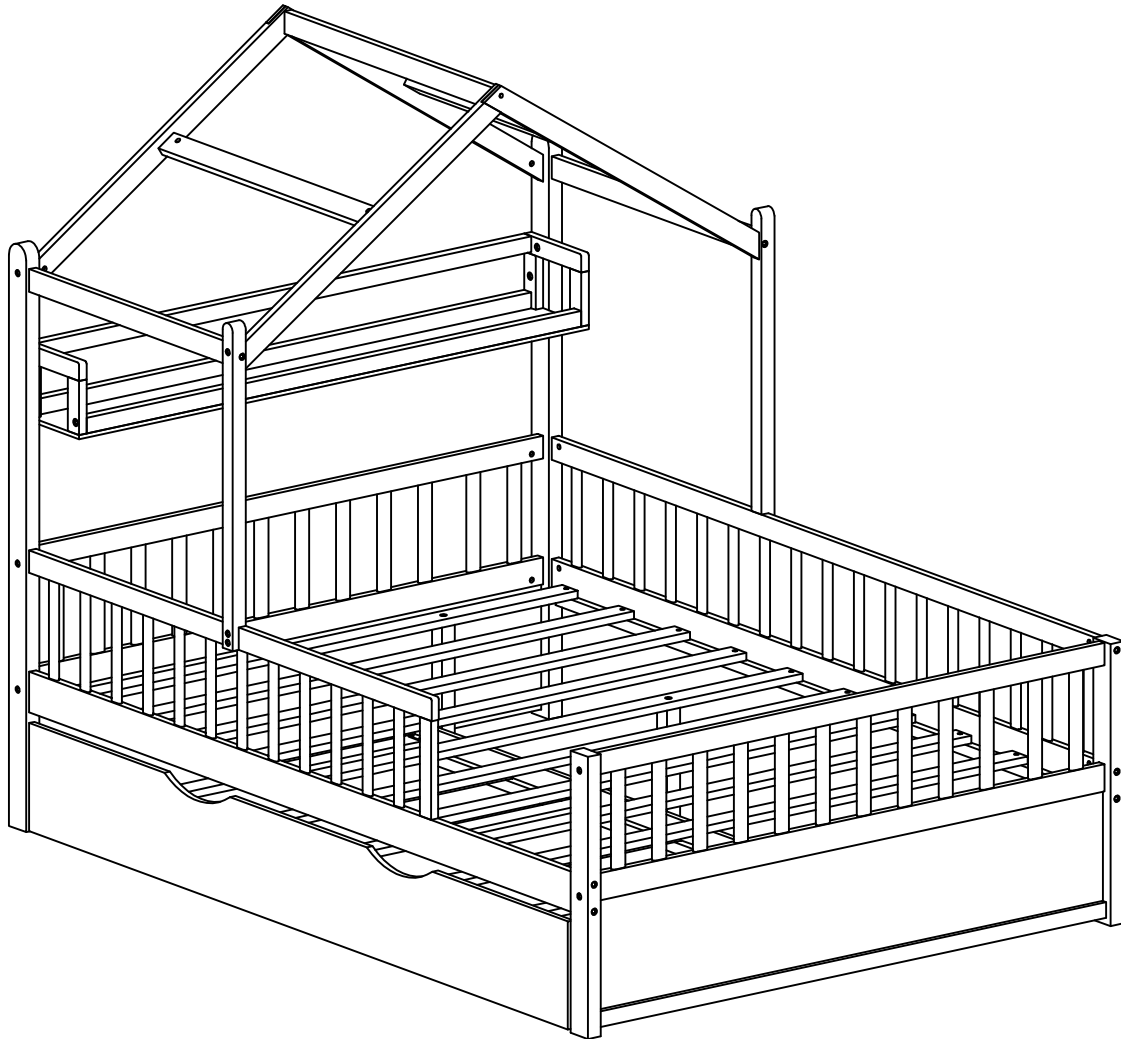

Detail:

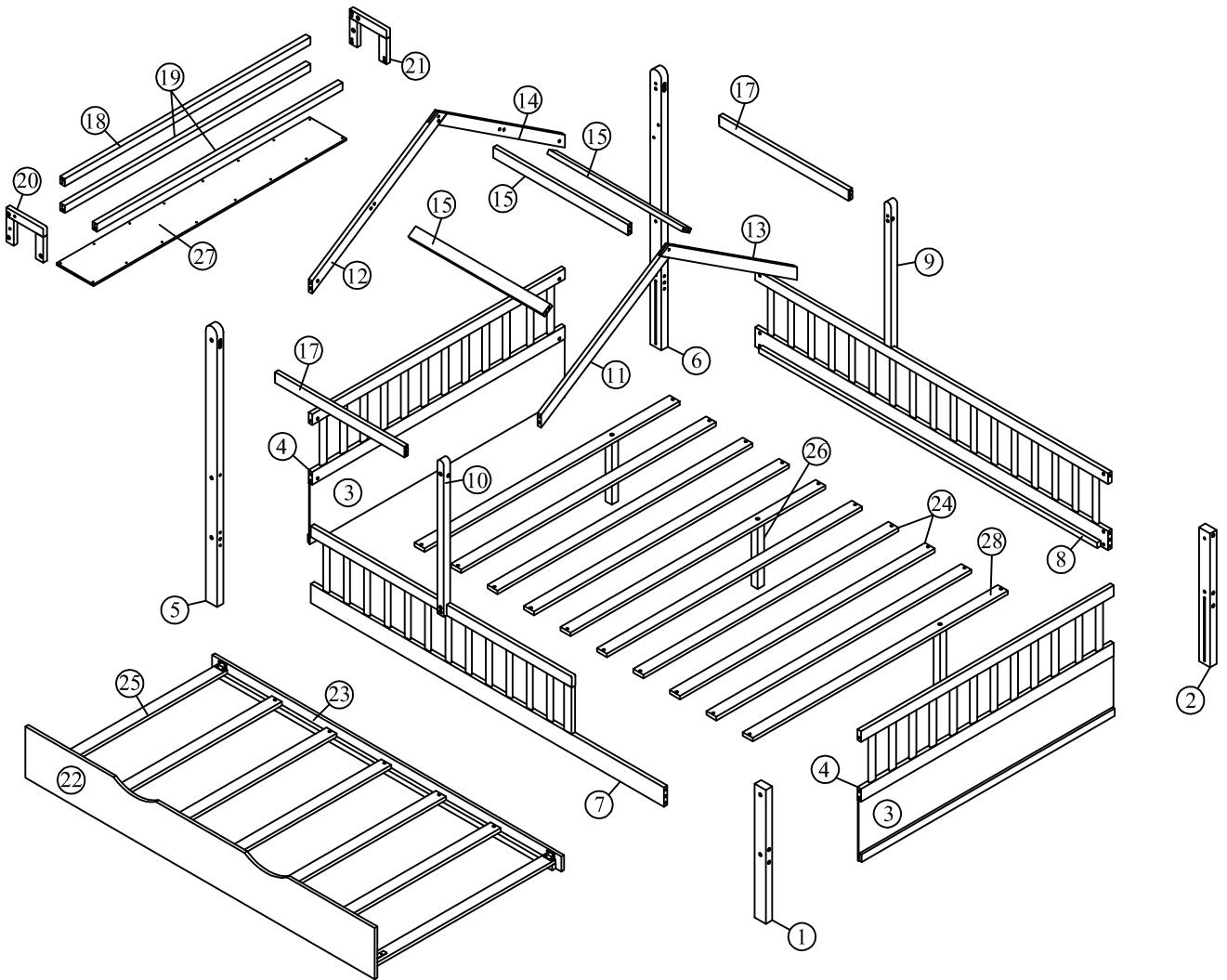

# Part List (WF309182)

① x1

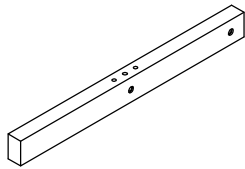

**Front Right Leg**

② x1

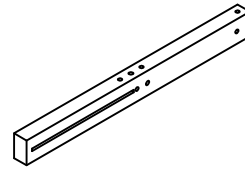

**Back Right Leg**

③ x2

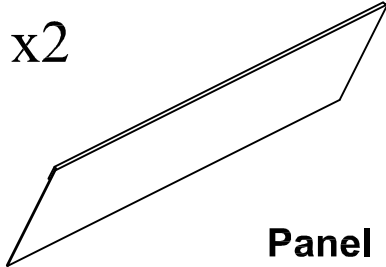

**Panel Headboard**

④ x2

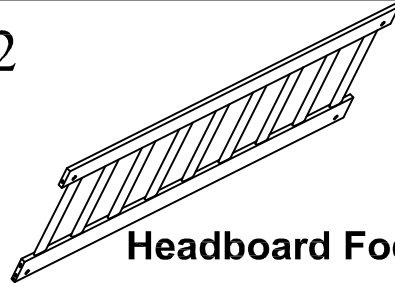

**Headboard Fodboard**

⑤ x1

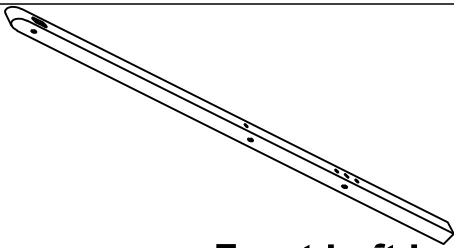

**Front Left Leg**

⑥ x1

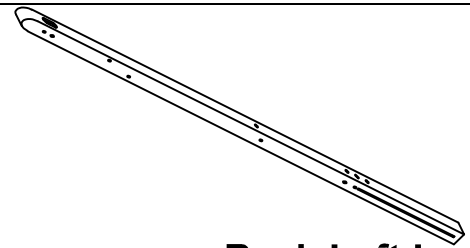

**Back Left Leg**

⑦ x1

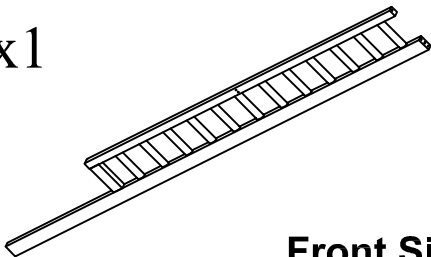

**Front Side Rail**

⑧ x1

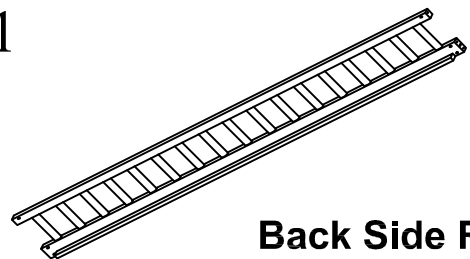

**Back Side Rail**

⑨ x1

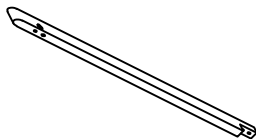

**Frame Headboard**

⑩ x1

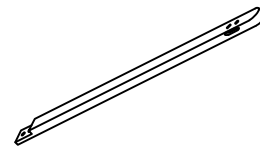

**Frame Headboard**

⑪ x1

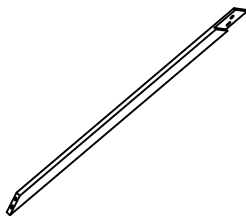

**Frame Roof Rail**

⑫ x1

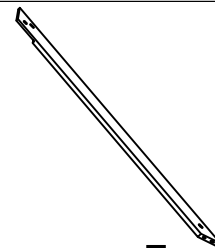

**Frame Roof Rail**

⑬ x1

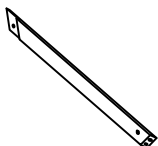

**Frame Roof Rail**

⑭ x1



**Frame Roof Rail**

# Part List (WF309182)

15 x3

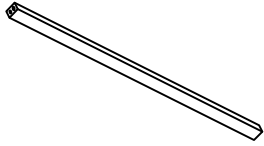

Roof Rail

17 x2

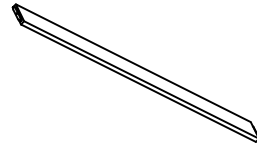

Roof Rail

18 x1

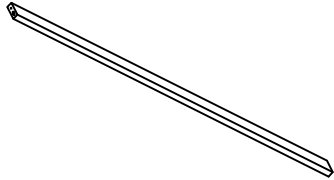

Shelt

19 x2

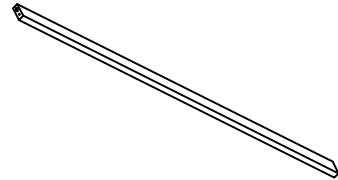

Shelt

20 x1

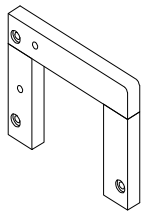

Left Side Shelf

21 x1

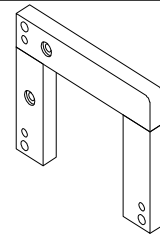

Right Side Shelf

22 x1

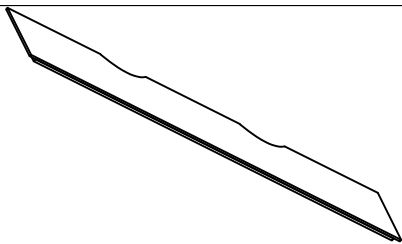

Front Trundle

23 x1

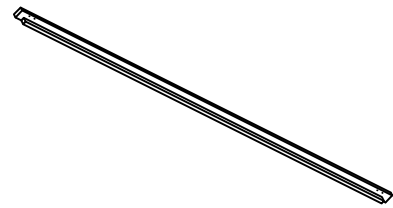

Back Trundle

24 x7

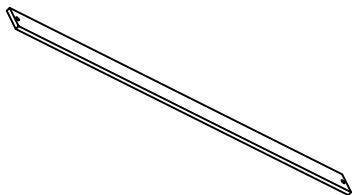

Slats

25 x7

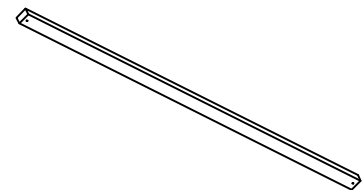

Slats Trundle

26 x3

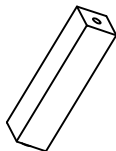

Support Slats

27 x1

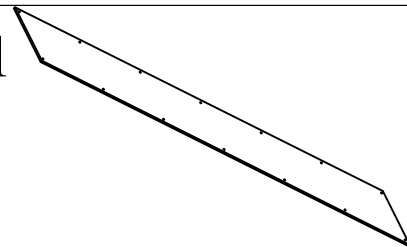





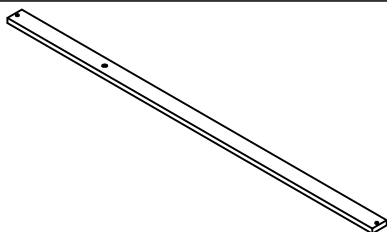





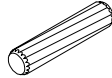

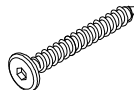

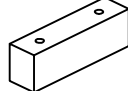
Bottom Trundle

28 x3

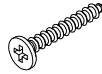

Slats



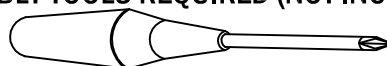

## Hardware List (WF309182)

| No. | OUTLOOK   | DESC                     | QTY |
|-----|---|--------------------------|-----|
| (A) |    | Dowel Ø10*40mm           | 24  |
| (B) |    | Bolts 1/4"*100mm         | 11  |
| (C) |    | Screws Ø6.5*50mm         | 8   |
| (D) |    | Screws Ø6.5*80mm         | 2   |
| (E) |    | Bolts 1/4"*70mm          | 18  |
| (F) |    | Stop Wood                | 2   |
| (G) |    | Bolts 1/4"*35mm          | 7   |
| (H) |   | Bolts 1/4"*20mm          | 4   |
| (I) |  | Cross dowel 1/4"*13mm    | 29  |
| (J) |  | Screws #7*12mm           | 32  |
| (K) |  | Flat head screw #8*35mm  | 38  |
| (L) |  | Round head screw #8*20mm | 14  |
| (M) |  | Allen key 60*22*4mm      | 1   |
| (N) |  | Wheels                   | 4   |
| (O) |  | Base L Big               | 2   |
| (P) |  | Base L small             | 2   |

ASSEMBLY TOOLS REQUIRED (NOT INCLUDED)





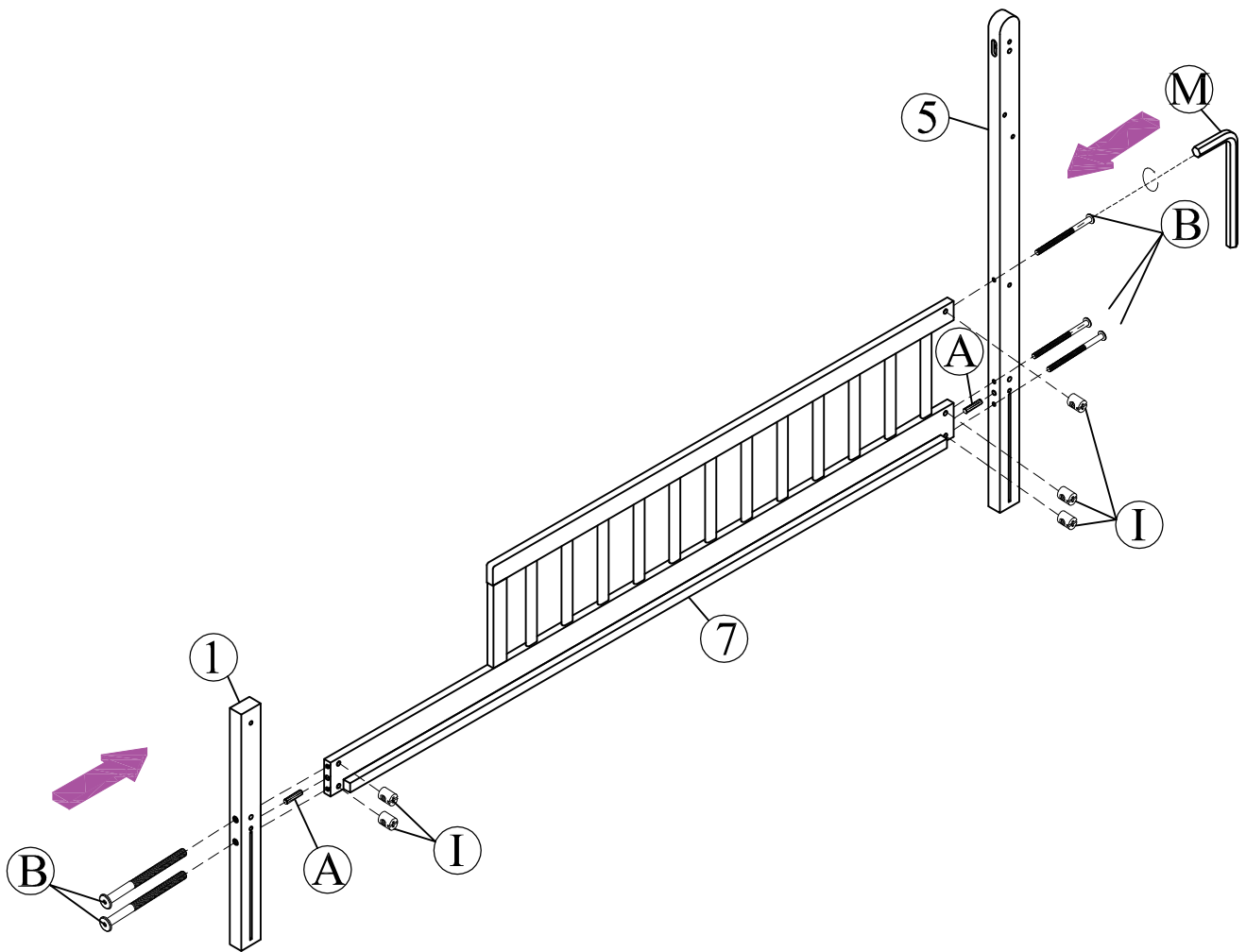

STEP 1:

|     |   |    |
|-----|---|----|
| (A) |  | 02 |
| (B) |  | 05 |
| (I) |  | 05 |
| (M) |  | 01 |





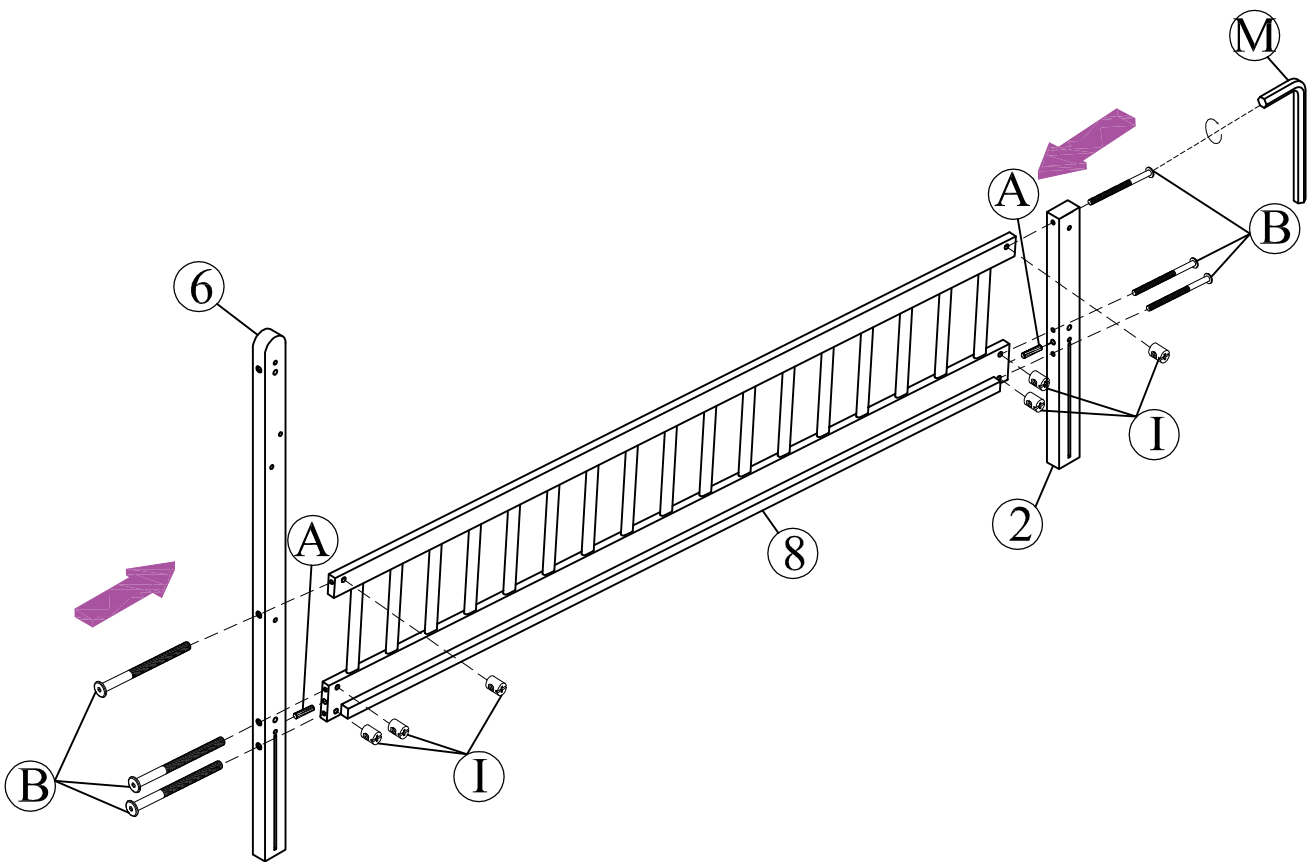

STEP 2:

|     |   |    |
|-----|---|----|
| (A) |  | 02 |
| (B) |  | 06 |
| (I) |  | 06 |
| (M) |  | 01 |



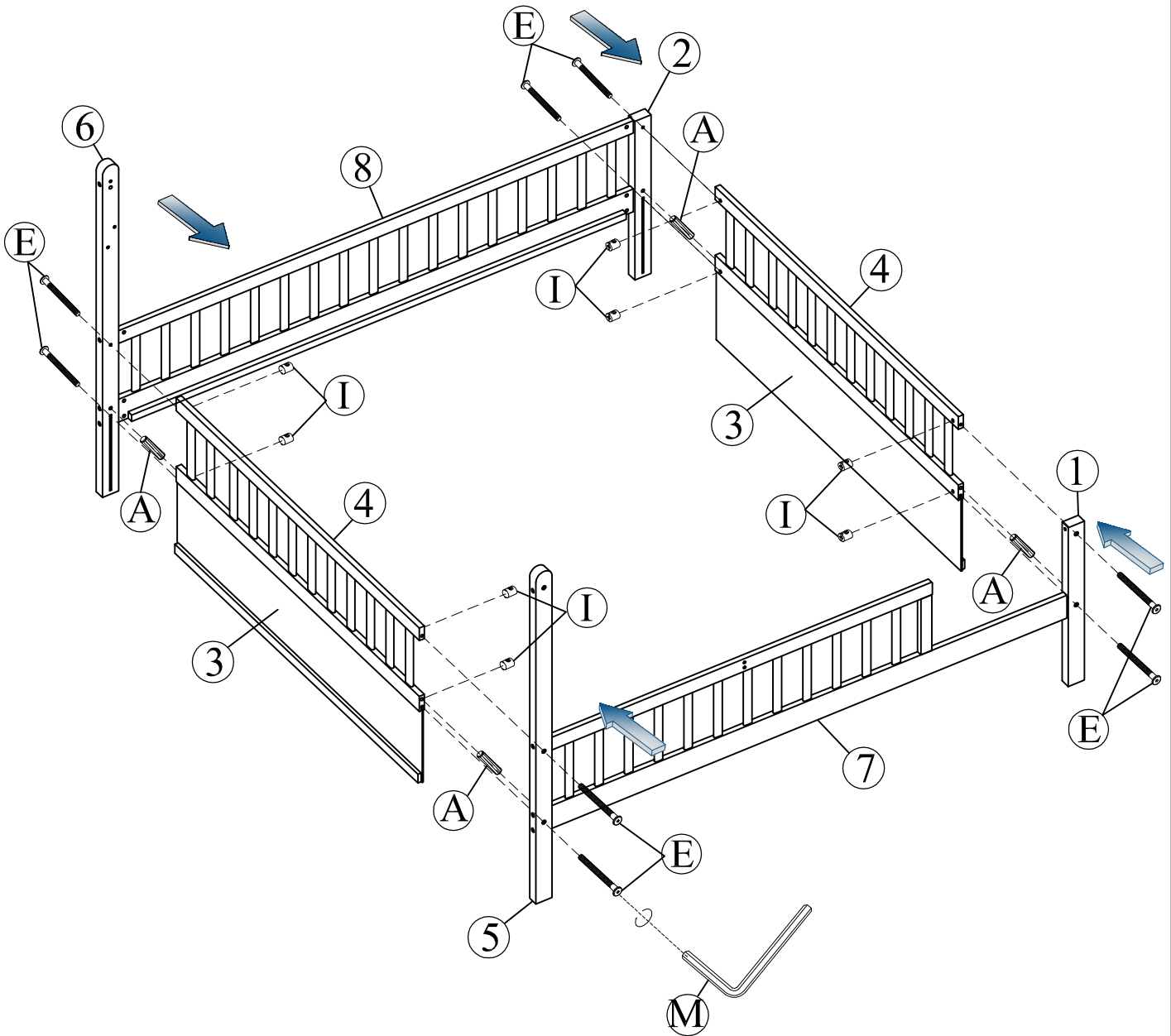

**STEP 3:**

|     |   |    |
|-----|---|----|
| (A) |  | 04 |
| (E) |  | 08 |
| (I) |  | 08 |
| (M) |  | 01 |





**STEP 4:**

|     |   |    |
|-----|---|----|
| (J) |  | 16 |
| (N) |  | 04 |

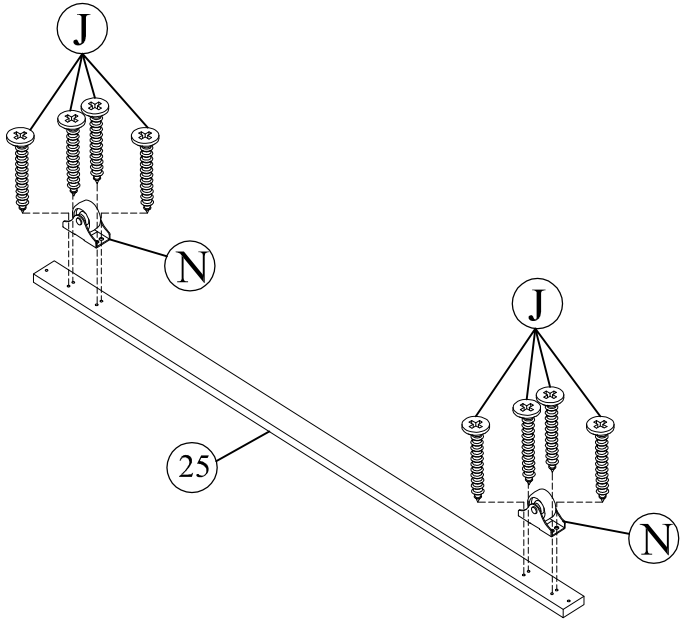

X2

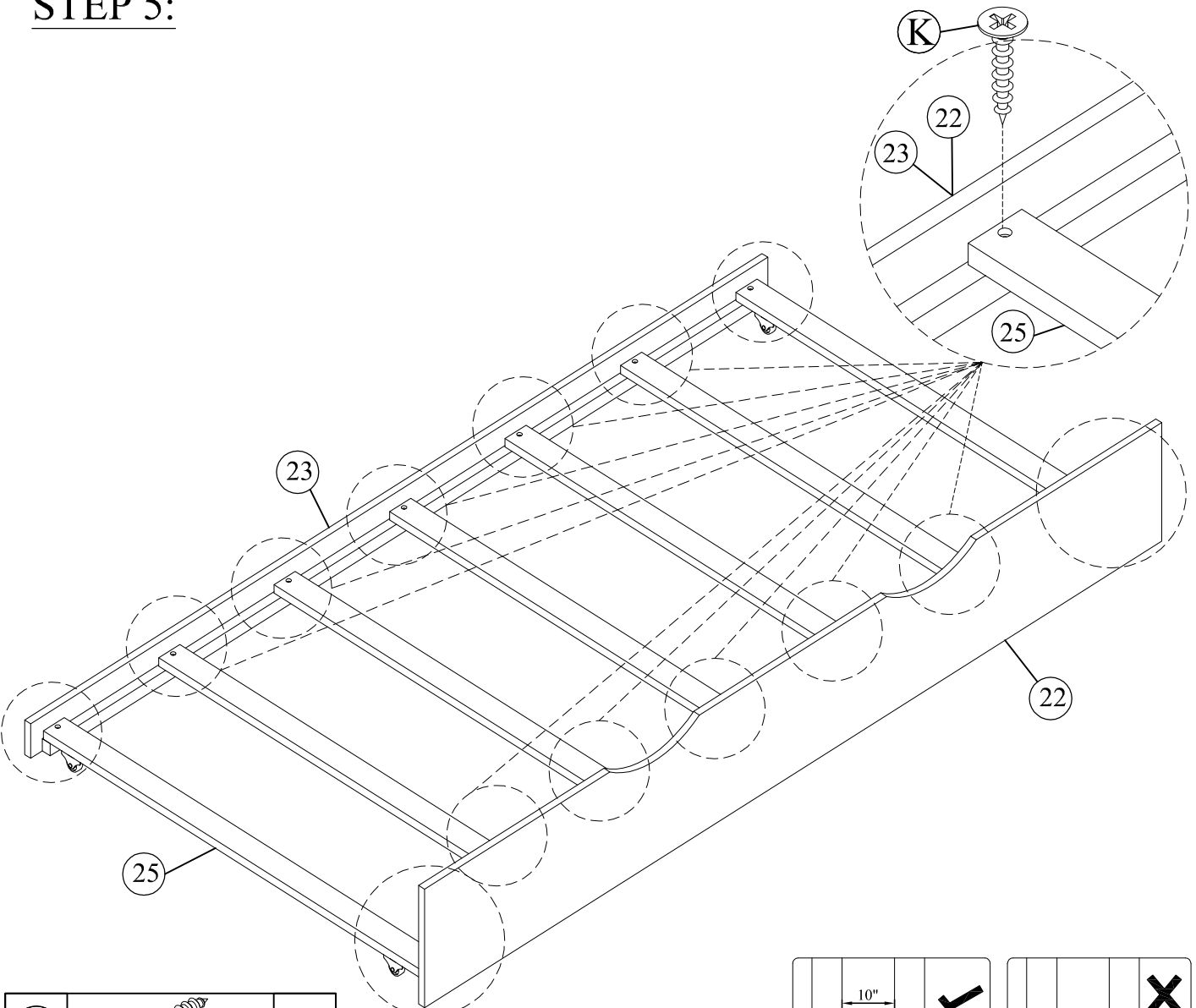

**STEP 5:**

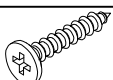

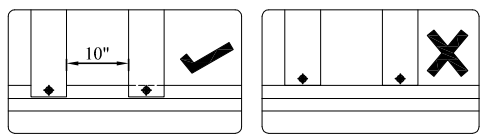
|     |   |    |
|-----|---|----|
| (K) |  | 14 |
|-----|---|----|



**STEP 6:**

|     |   |    |
|-----|---|----|
| (J) |  | 16 |
| (O) |  | 02 |
| (P) |  | 02 |

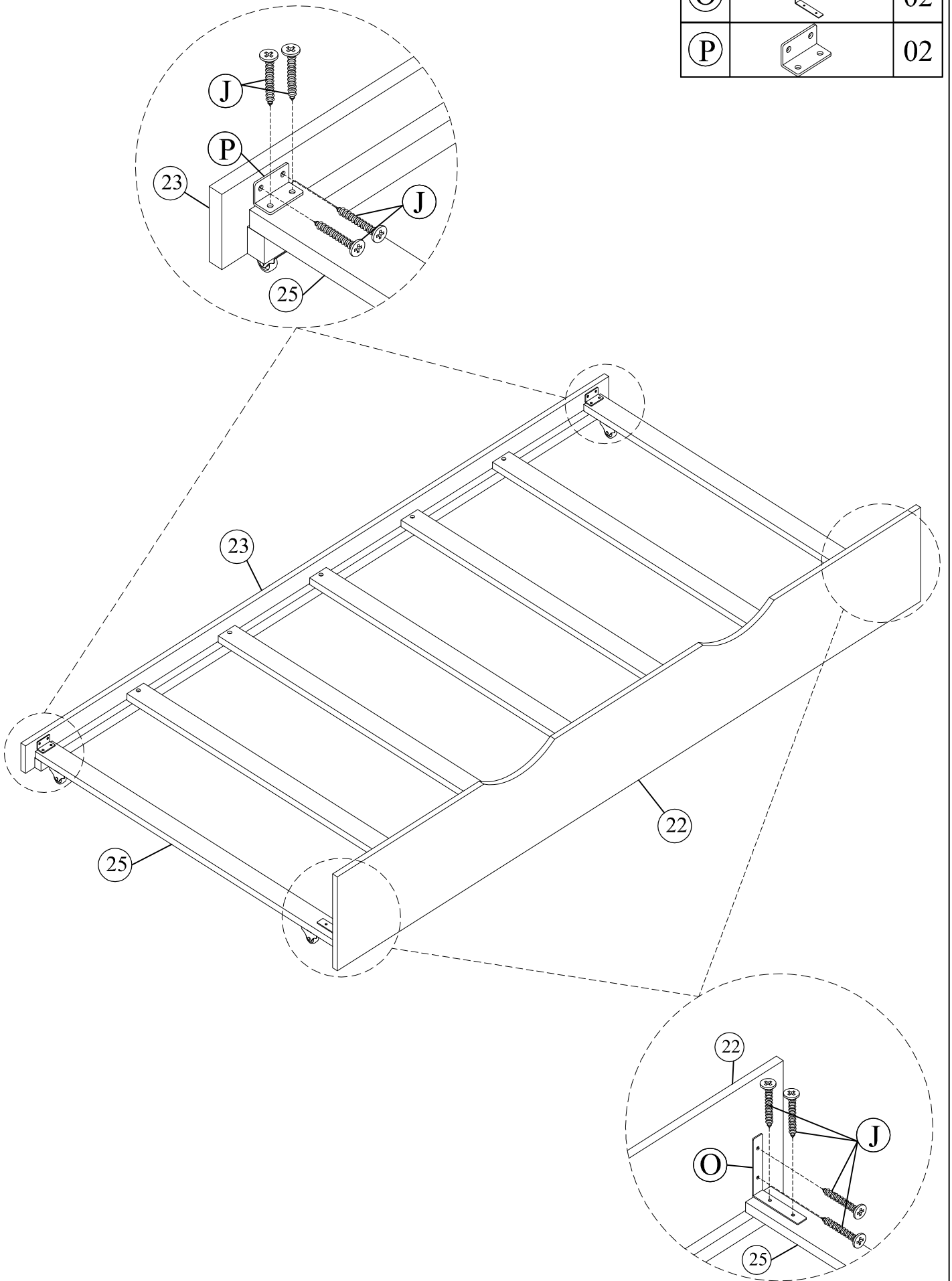

# STEP 7:

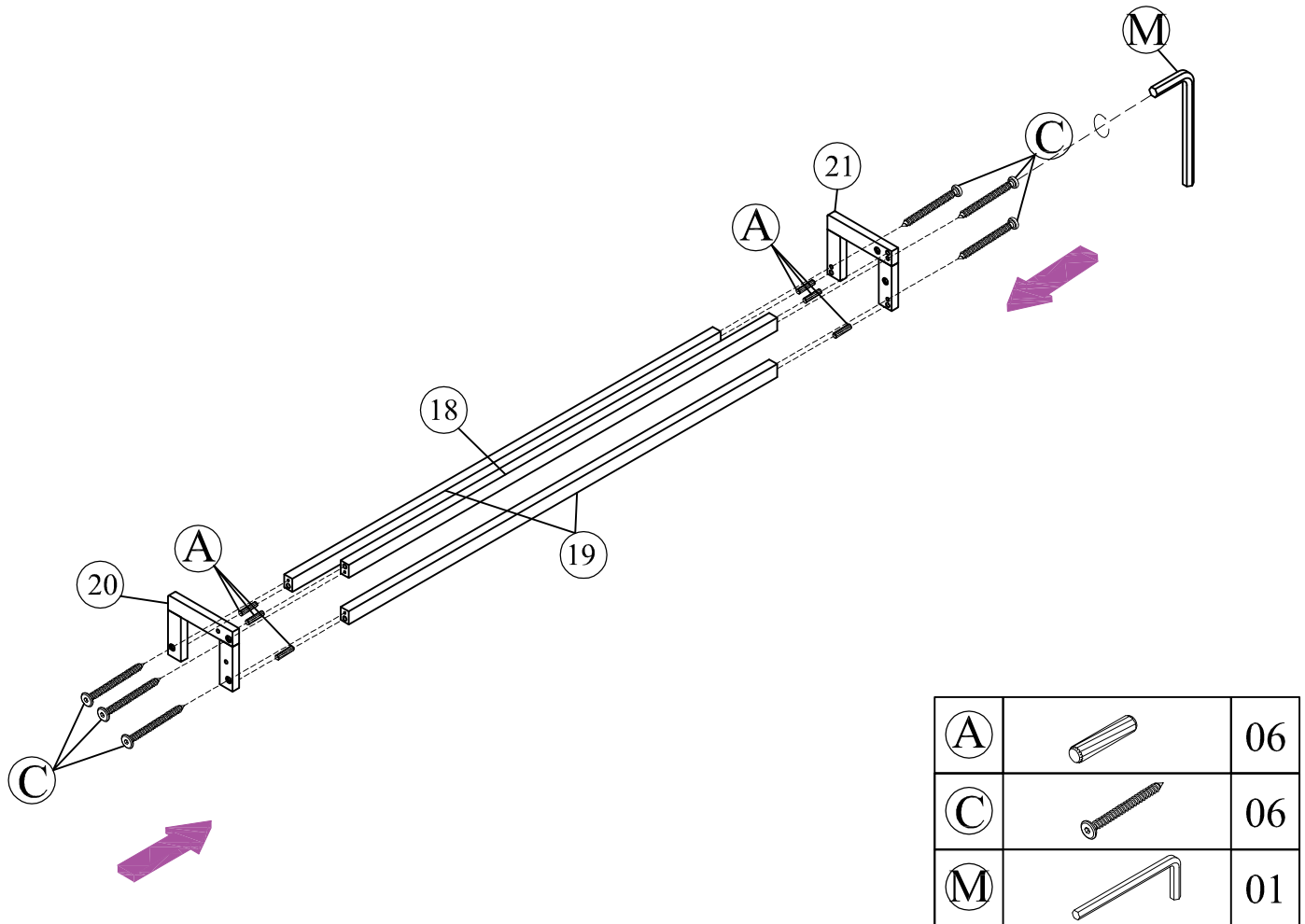

|     |  |    |
|-----|--|----|
| (A) |  | 06 |
| (C) |  | 06 |
| (M) |  | 01 |

# STEP 8:

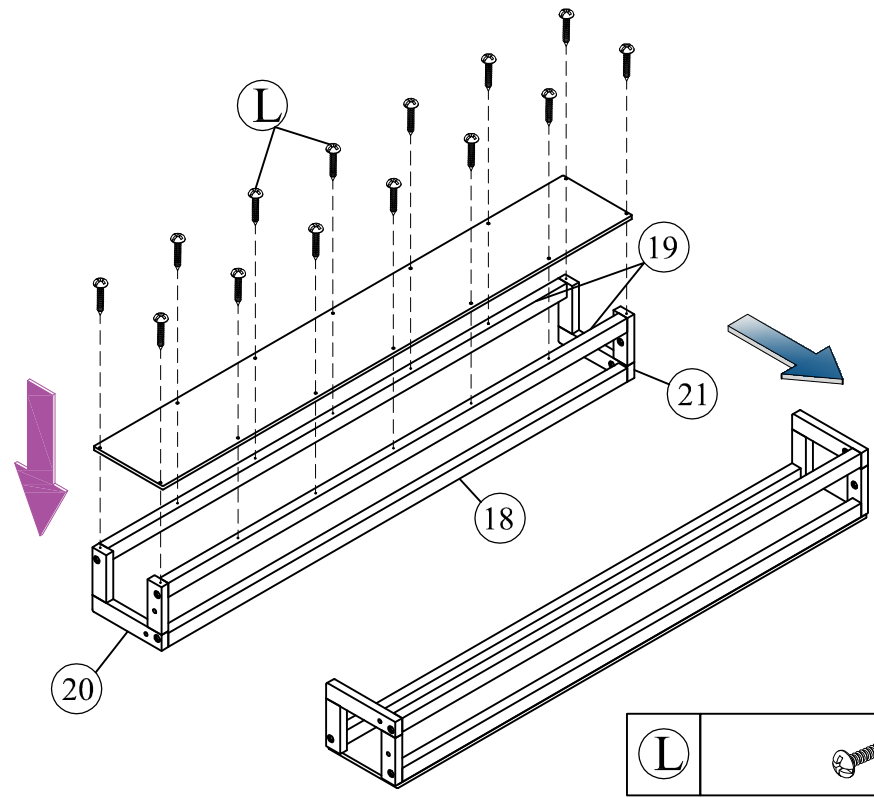

|     |  |    |
|-----|--|----|
| (L) |  | 14 |
|-----|--|----|

**STEP 9:**

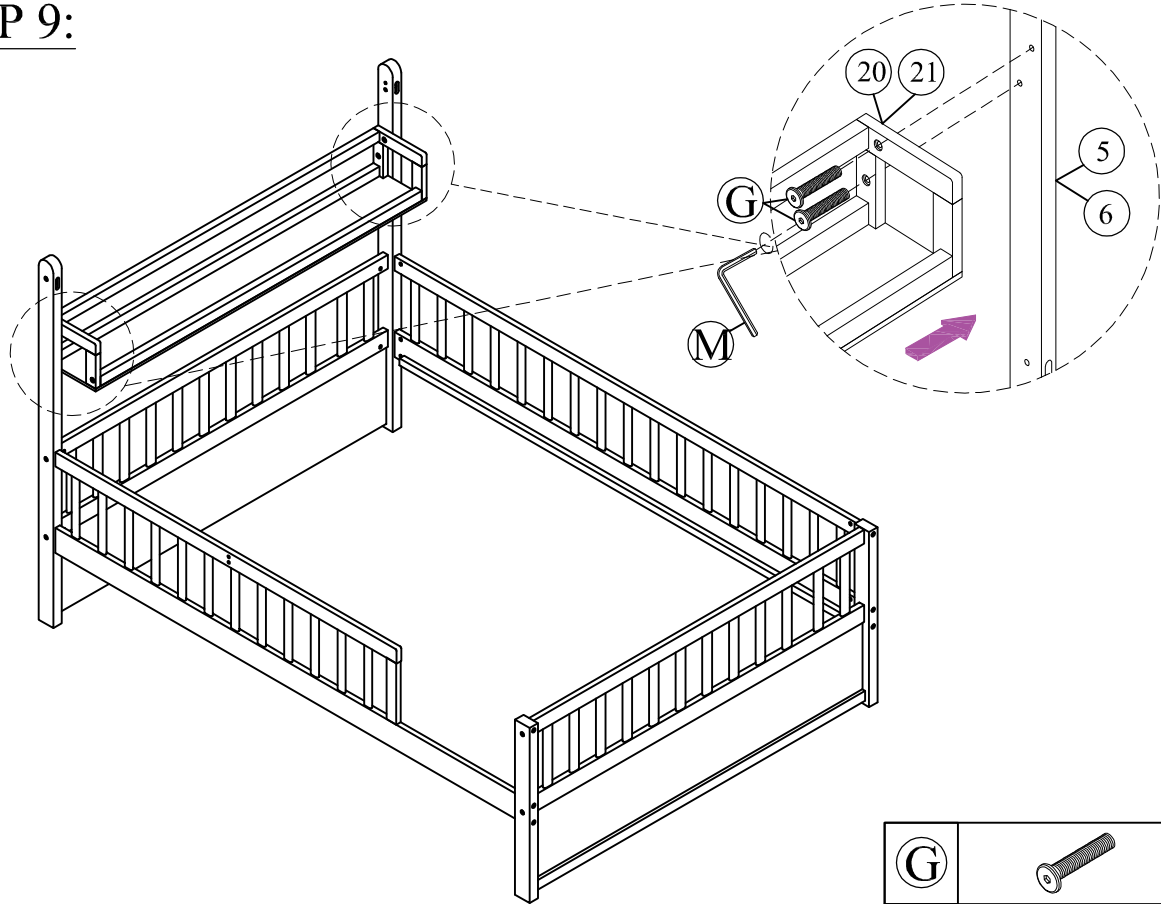



|     |  |    |
|-----|--|----|
| (G) |  | 04 |
| (M) |  | 01 |

**STEP 10:**

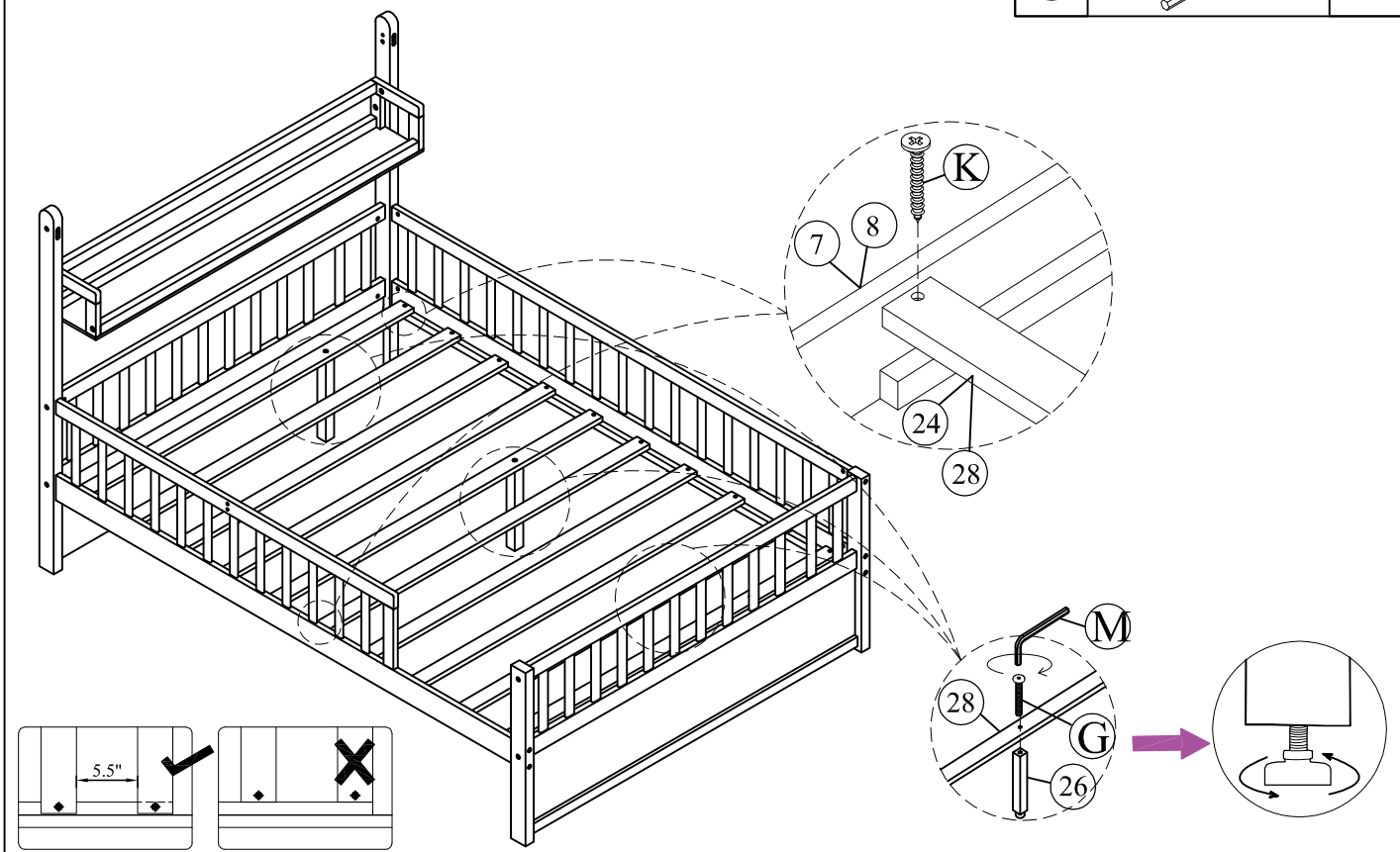
|     |  |    |     |  |    |
|-----|--|----|-----|--|----|
| (K) |  | 20 | (G) |  | 03 |
|     |  |    | (M) |  | 01 |

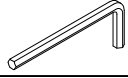

**STEP 11:**

|     |   |    |
|-----|---|----|
| (A) |  | 06 |
| (E) |  | 06 |
| (I) |  | 06 |
| (M) |  | 01 |

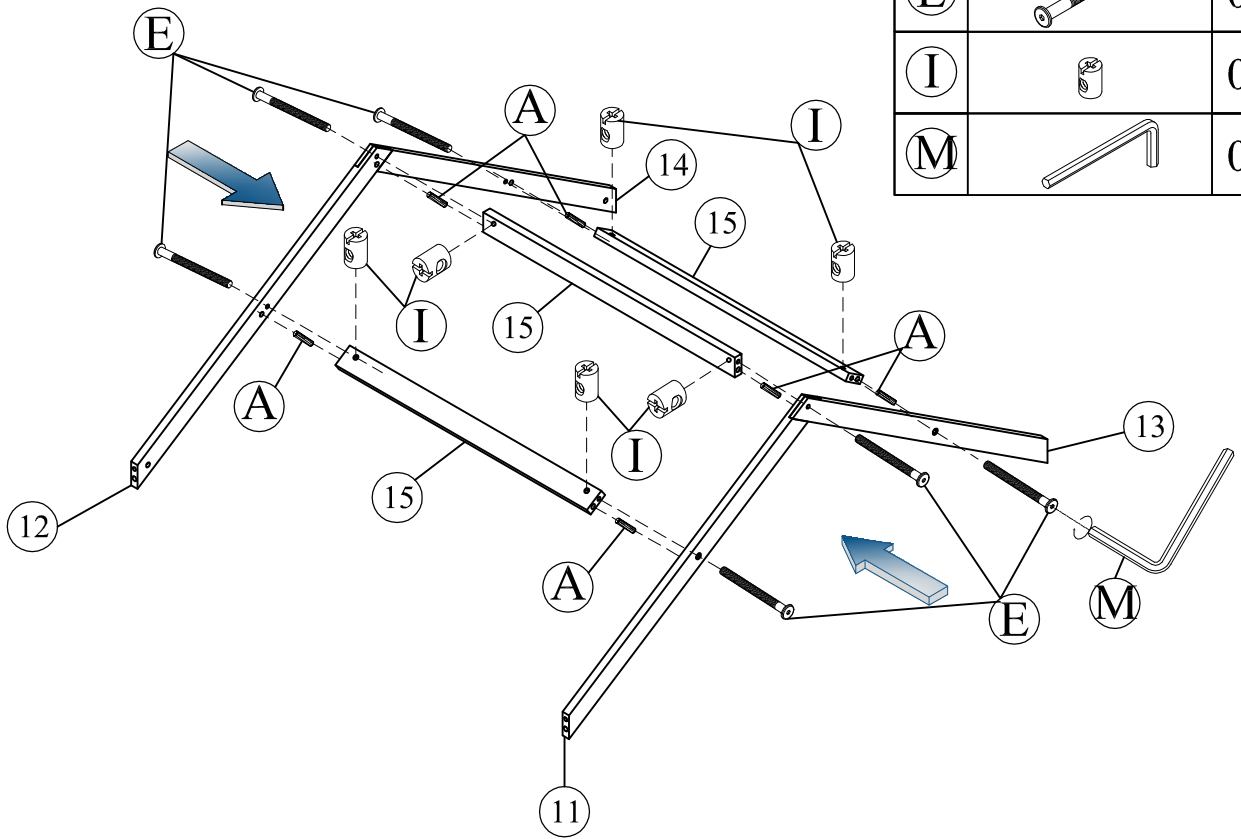

**STEP 12:**

**STEP 13:**

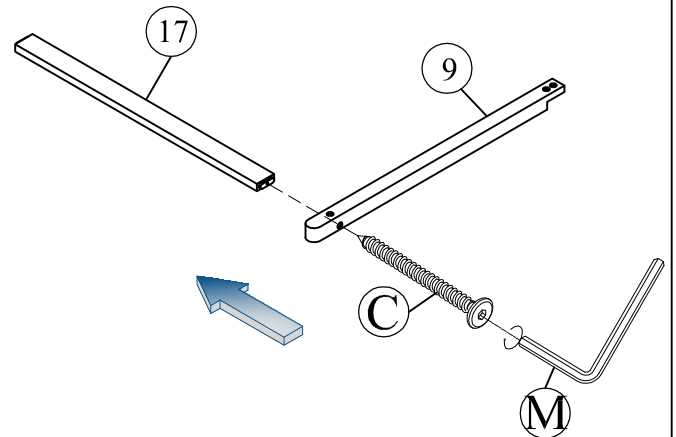
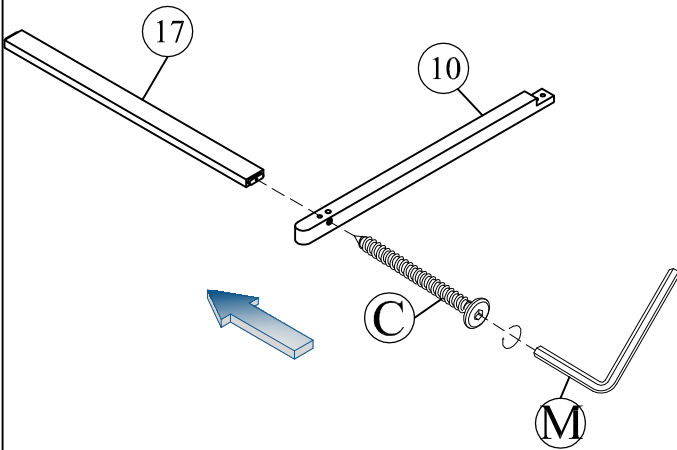

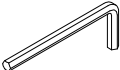
|     |   |    |
|-----|---|----|
| (C) |  | 01 |
| (M) |  | 01 |

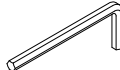
|     |  |    |
|-----|--|----|
| (C) |  | 01 |
| (M) |  | 01 |

# STEP 14:

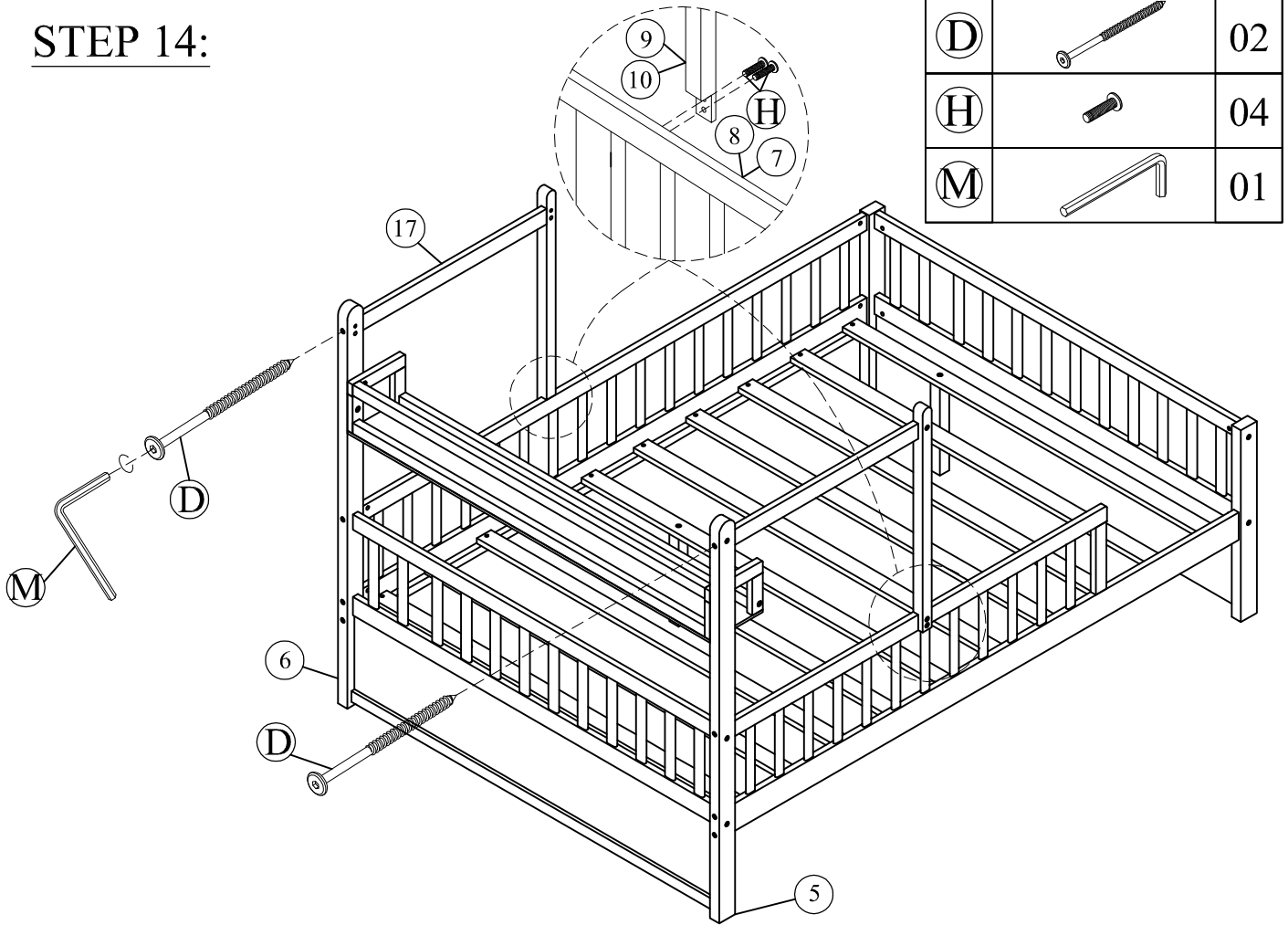

# STEP 15:

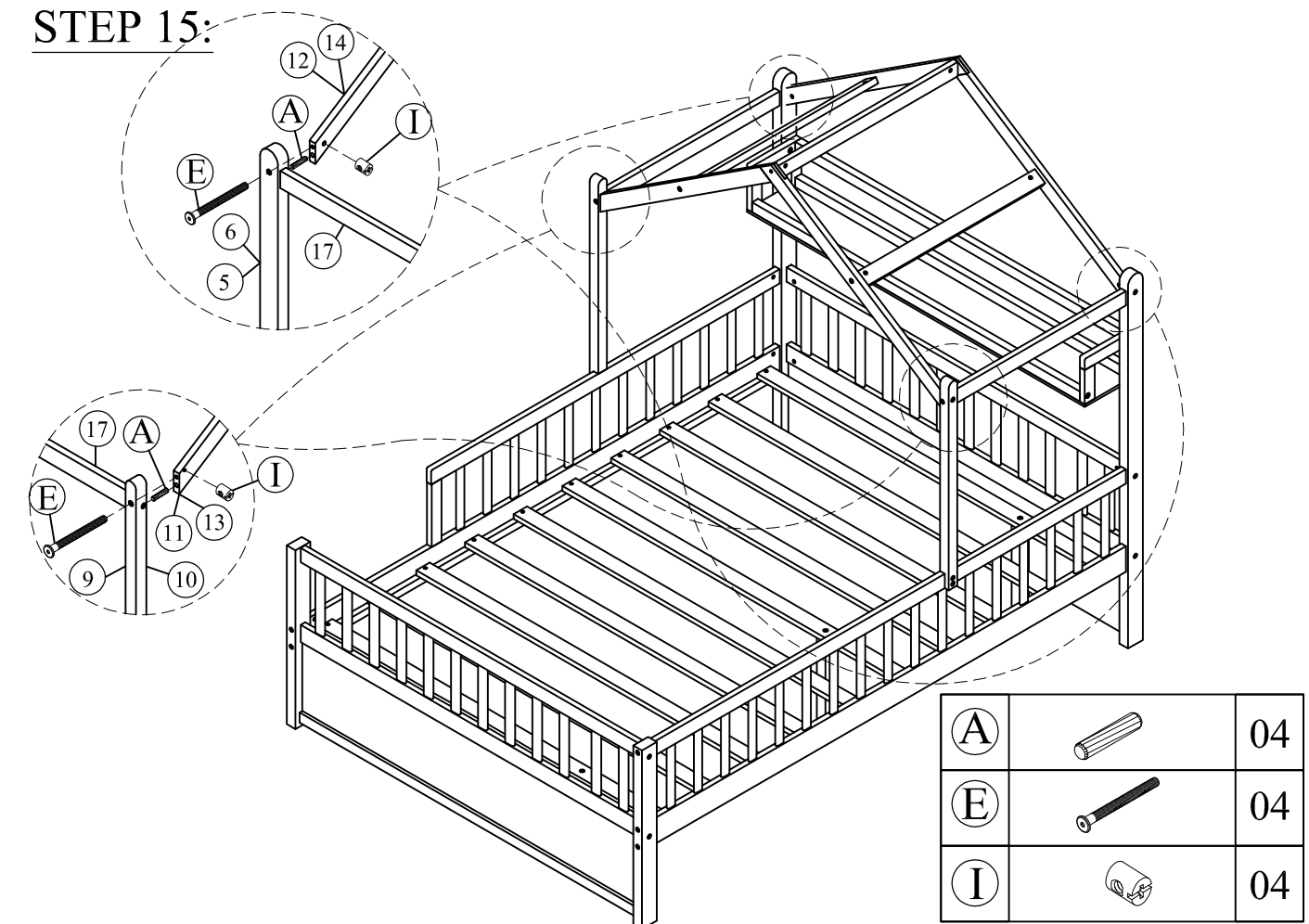

**STEP 16:**

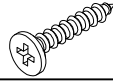
|   |   |    |
|---|---|----|
| K |  | 04 |
|---|---|----|

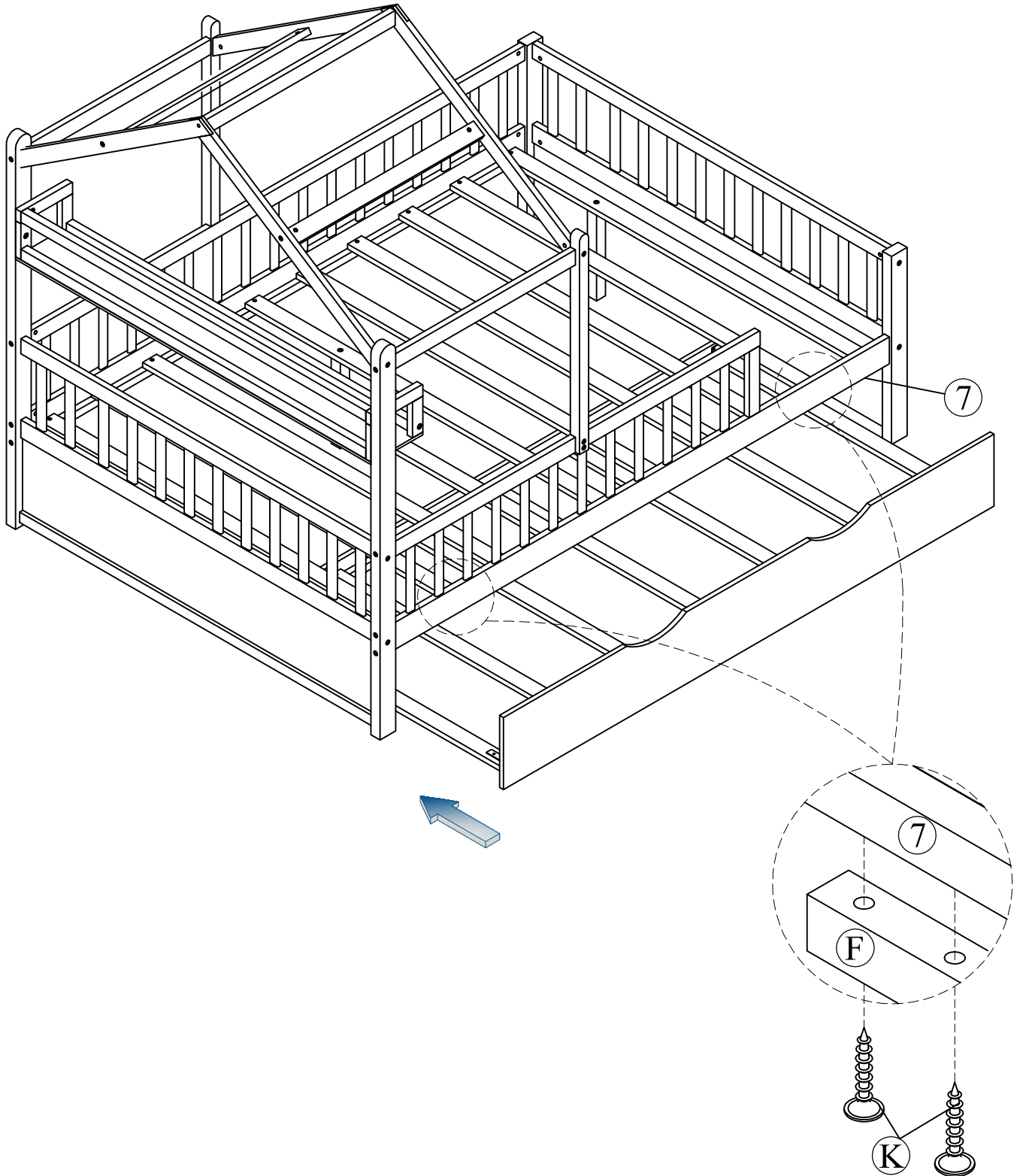

OPTION 1:

