

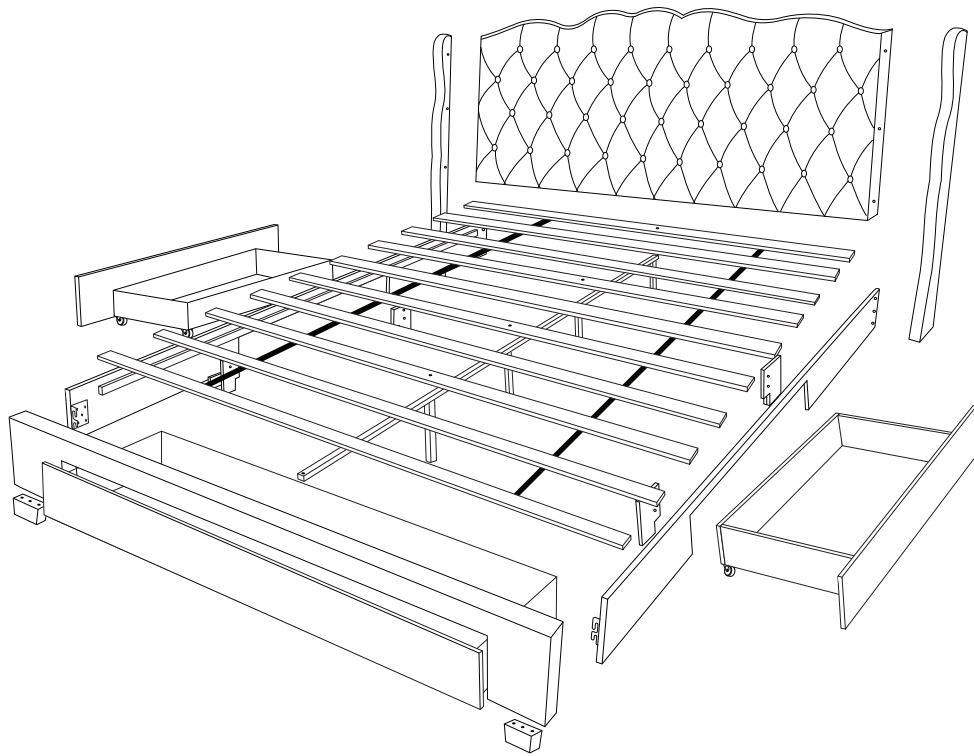





ASSEMBLY INSTRUCTION

SKU CODE : WF 303283 / WF 303284

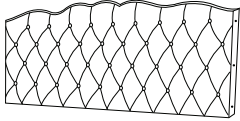

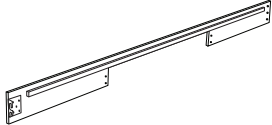
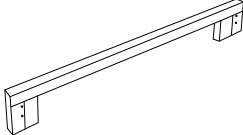
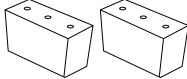
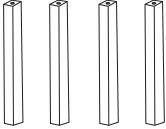

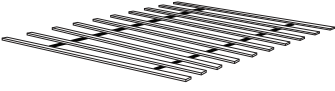



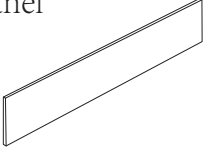
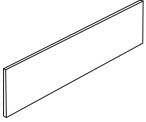
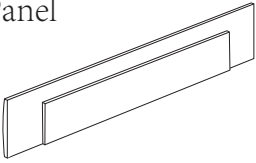
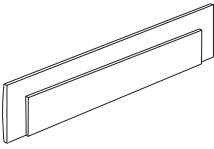
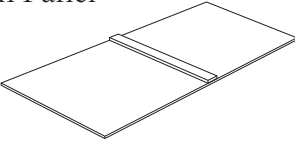
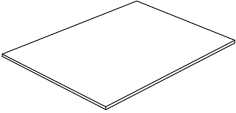
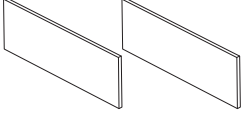

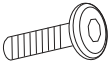

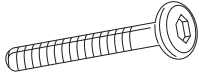
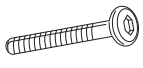

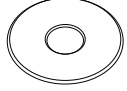
Detail View - CURVE BED (QUEEN)

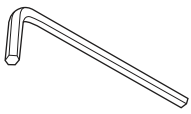
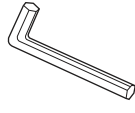
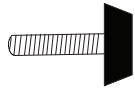

NO	PART LIST	QTY
A	Headboard 	1 pc
B	Side Rail Support (L) 	2 pcs
C	Side Rail 	2 pcs
D	Footboard 	1 pc
E	Bed Leg 	2 pcs
F	Center Support Leg 	4 pcs
G	Wing 	2 pcs
H	Bed Slat 	10 pcs
I	Center Support Rail 	1 pc
J	Side Rail Support (R) 	2 pcs

NO	PART LIST	QTY
K	Footboard's Drawer Back Panel 	1 pc
L	Side's Drawer Back Panel 	2 pcs
M	Footboard's Drawer Front Panel 	1 pc
N	Side's Drawer Front Panel 	2 pcs
O	Footboard's Drawer Bottom Panel 	1 pc
P	Side's Drawer Bottom Panel 	2 pcs
Q	Drawer Side Panel 	6 pcs

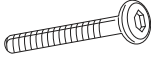
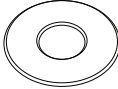
NO	HARDWARE LIST	QTY
1	JCBB M8 x 20mm 	4 pcs
2	JCBC M6 x 70mm 	2 pcs
3	JCBC M6 x 60mm 	4 pcs
4	JCBC M6 x 35mm 	7 pcs
5	JCBB M8 x 25mm 	8 pcs
6	Flat Washer M6 	14 pcs
7	Spring Washer M6 	6 pcs
8	CSK M4 x 30mm 	44 pcs
9	Dowel M8 	4 pcs
10	Allen Key M4 	1 pc
11	Allen Key M5 	1 pc
12	Adjuster M6 	4 pcs
13	CSK M3.5 x 12mm 	44 pcs

NO	HARDWARE LIST	QTY
14	Wheel 	14 pcs
15	JCBB M8 x 40mm 	6 pcs
16	Flat Washer M8 	6 pcs
17	Spring Washer M8 	6 pcs



Read this instruction carefully. Remove all wrapping material, staples and straps from the carton. See hardware and furniture part list for guidance. Be sure you have all wooden furniture parts on a clean and flat surface, such as carpet or rug, to prevent from being scratched.

CAUTION :

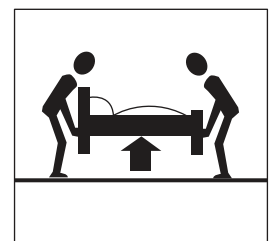
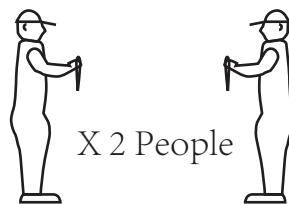
1. Do not Full Tighten the nut or screw until all ready to assemble.
2. Do not Over Tighten the nut or screw to avoid causing damages to the thread.
3. Keep all hardware part out reach of children.



STEP 1 Footboard's Drawer x 1 pc

8	13	14
		
8 pcs	20 pcs	6 pcs

Step 1

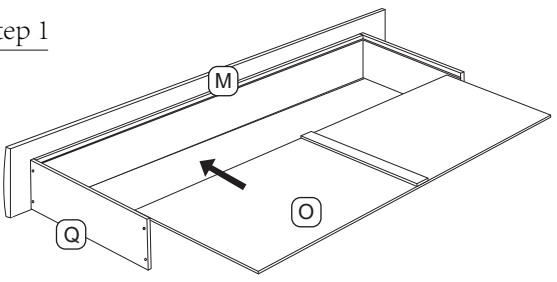

Step 2

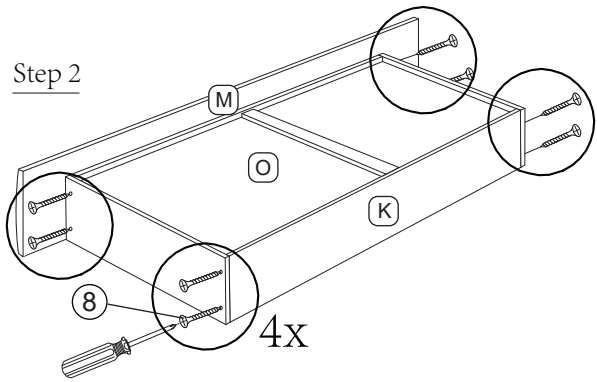

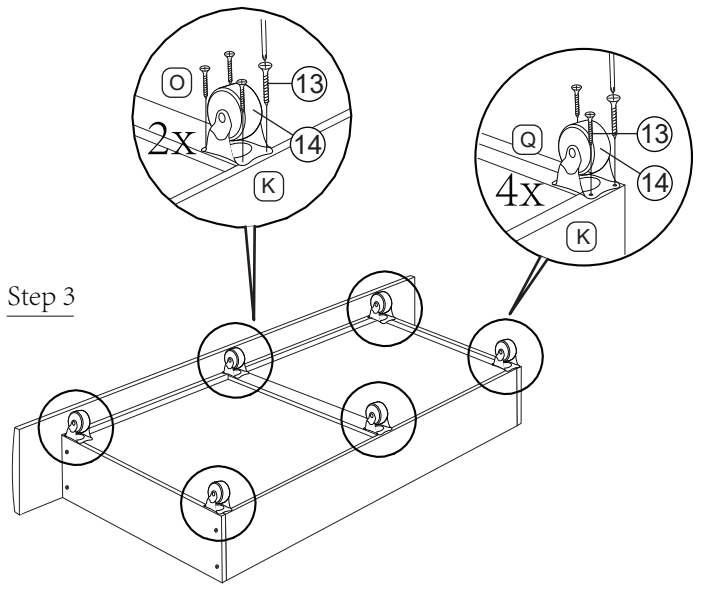

Step 3

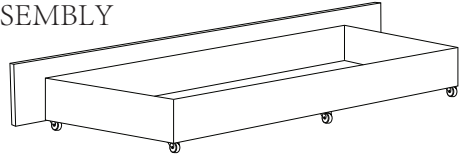

COMPLETED ASSEMBLY



STEP 2 Side's Drawer x 2 pcs

8	13	14
		
16 pcs	24 pcs	8 pcs

Step 1

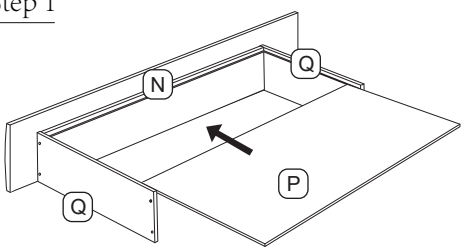

Step 2

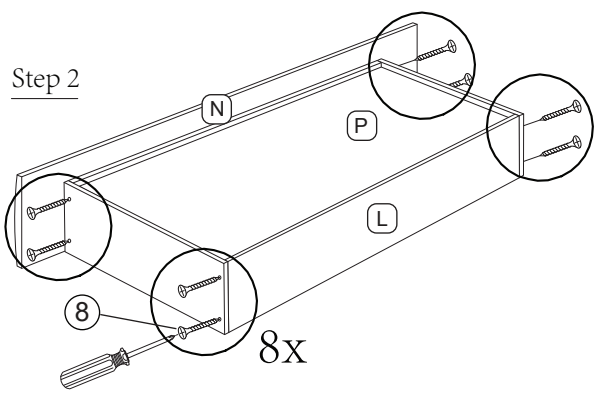



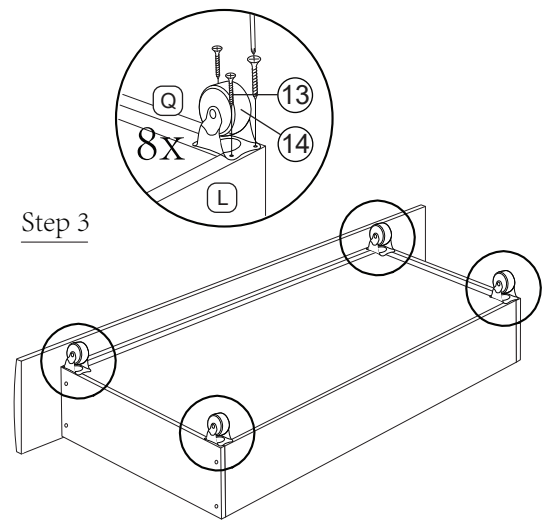

Step 3

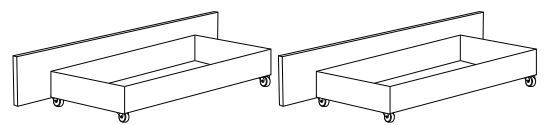

COMPLETED ASSEMBLY

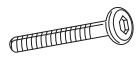

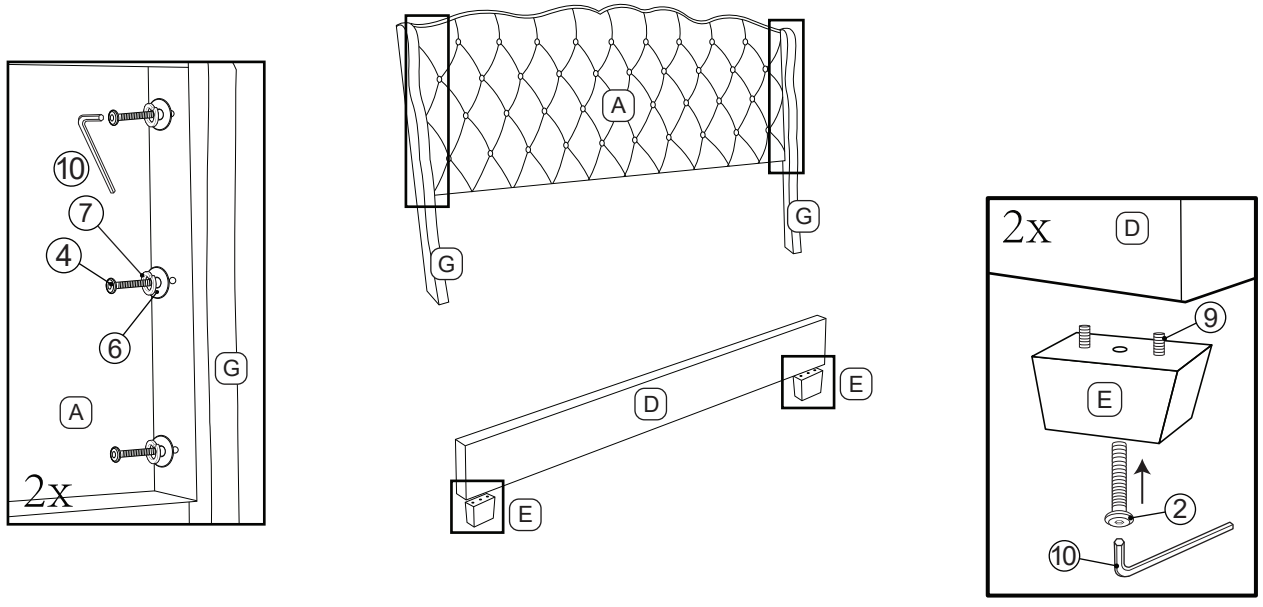

STEP 3

2	4	6	7	9
				
2 pcs	6 pcs	6 pcs	6 pcs	4 pcs



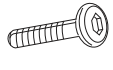

STEP 4

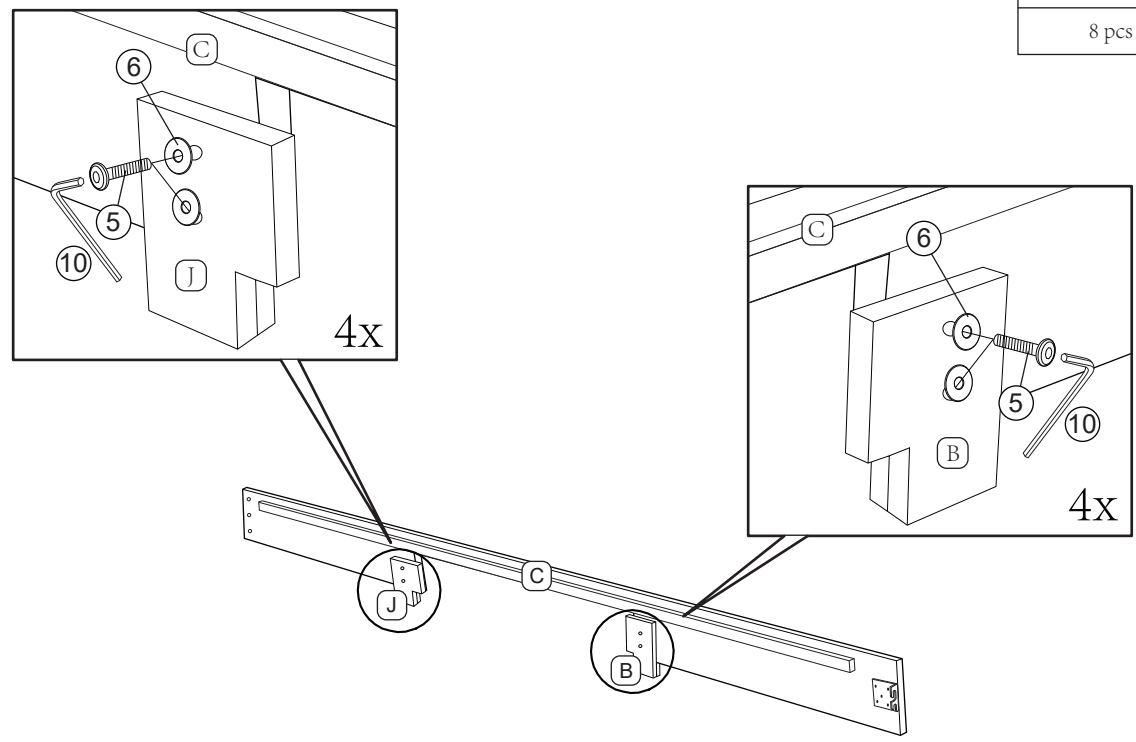
5	6
	
8 pcs	8 pcs



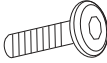

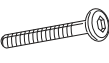
STEP 5

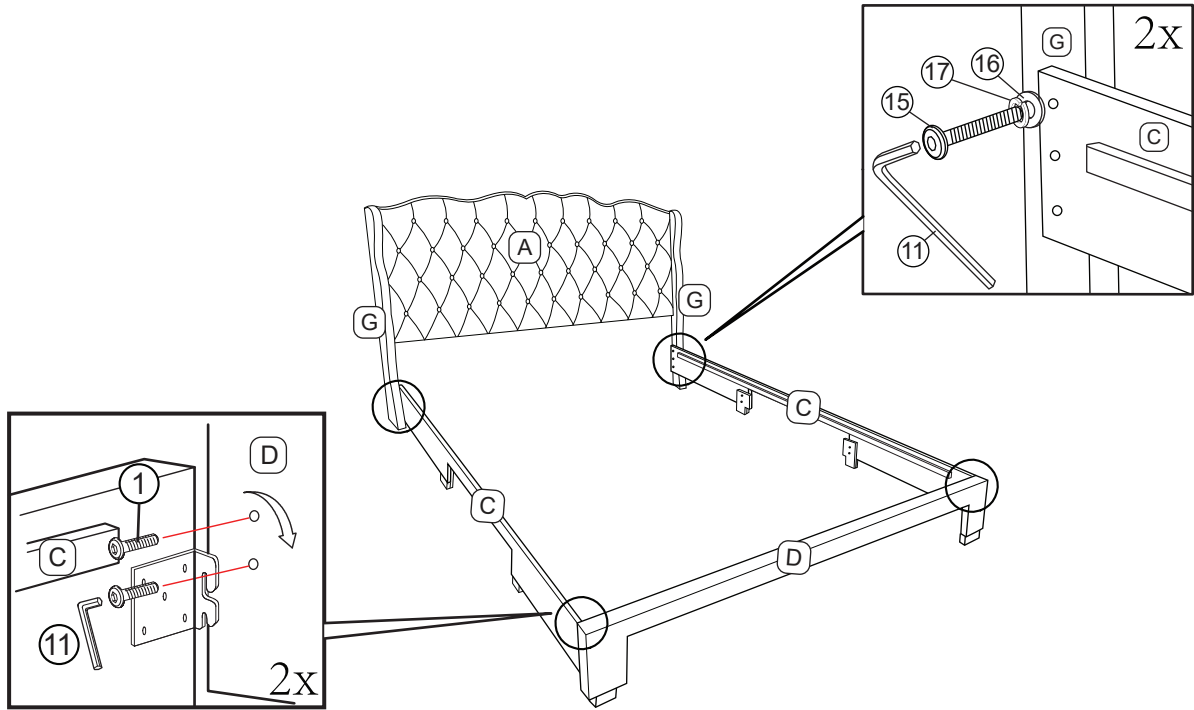
1	16	17	15
			
4 pcs	6 pcs	6 pcs	6 pcs

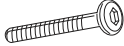

STEP 6

3	4	12
		
4 pcs	1 pc	4 pcs

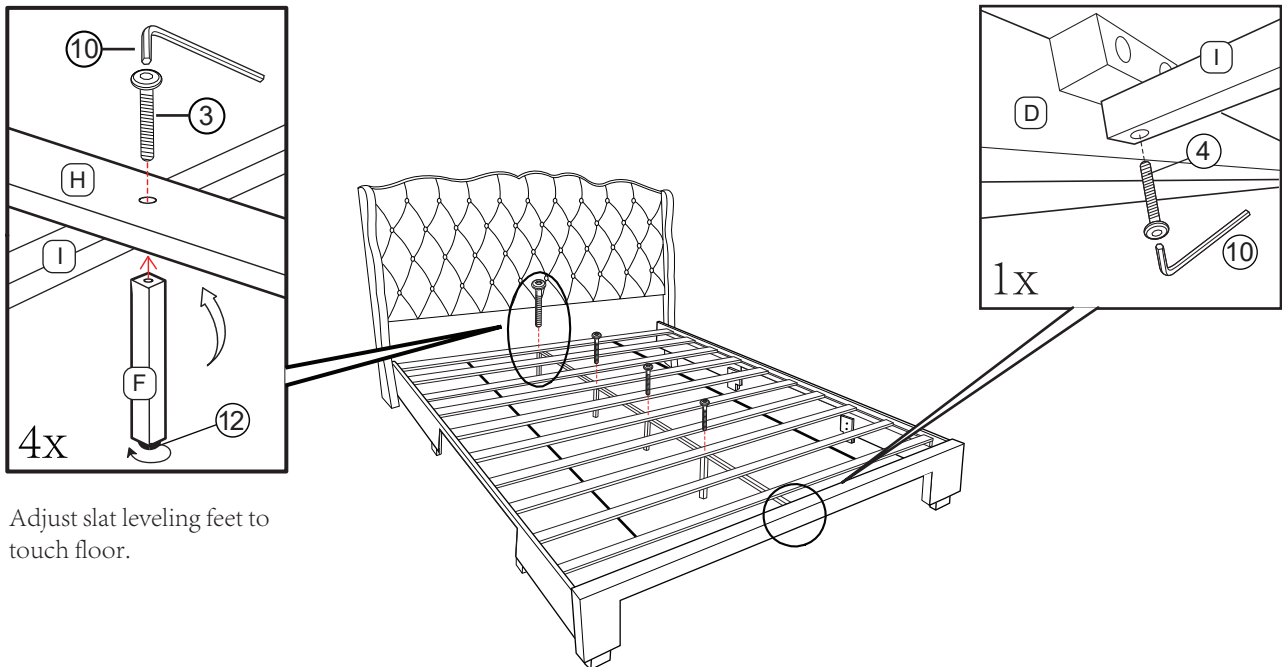

Adjust slat leveling feet to touch floor.



20 pcs

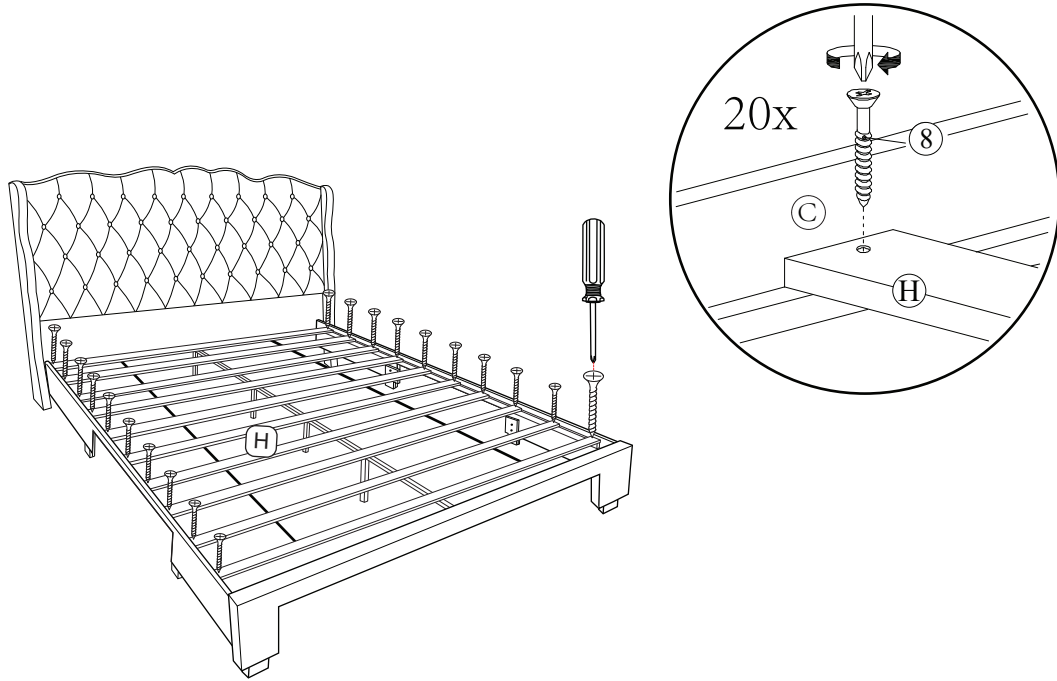

Lastly, place the drawers inside.

COMPLETED
ASSEMBLY

